

# Rules for the Classification of Steel Ships

## PART F – Additional Class Notations

NR 467.F1 DT R13 E

July 2021

---

Marine & Offshore  
Le Triangle de l'Arche - 8 cours du Triangle - CS50101  
92937 Paris la Défense Cedex- France  
Tel: + 33 (0)1 55 24 70 00  
<https://marine-offshore.bureauveritas.com/bv-rules>  
© 2021 Bureau Veritas - All rights reserved



**1. INDEPENDENCE OF THE SOCIETY AND APPLICABLE TERMS**

- 1.1 The Society shall remain at all times an independent contractor and neither the Society nor any of its officers, employees, servants, agents or subcontractors shall be or act as an employee, servant or agent of any other party hereto in the performance of the Services.
- 1.2 The operations of the Society in providing its Services are exclusively conducted by way of random inspections and do not, in any circumstances, involve monitoring or exhaustive verification.
- 1.3 The Society acts as a services provider. This cannot be construed as an obligation bearing on the Society to obtain a result or as a warranty. The Society is not and may not be considered as an underwriter, broker in Unit's sale or chartering, expert in Unit's valuation, consulting engineer, controller, naval architect, designer, manufacturer, shipbuilder, repair or conversion yard, charterer or shipowner; none of the above listed being relieved from any of their expressed or implied obligations as a result of the interventions of the Society.
- 1.4 Only the Society is qualified to apply and interpret its Rules.
- 1.5 The Client acknowledges the latest versions of the Conditions and of the applicable Rules applying to the Services' performance.
- 1.6 Unless an express written agreement is made between the Parties on the applicable Rules, the applicable Rules shall be the Rules applicable at the time of entering into the relevant contract for the performance of the Services.
- 1.7 The Services' performance is solely based on the Conditions. No other terms shall apply whether express or implied.

**2. DEFINITIONS**

- 2.1 "Certificate(s)" means classification or statutory certificates, attestations and reports following the Society's intervention.
- 2.2 "Certification" means the activity of certification in application of national and international regulations or standards ("Applicable Referential"), in particular by delegation from different governments that can result in the issuance of a Certificate.
- 2.3 "Classification" means the classification of a Unit that can result or not in the issuance of a classification Certificate with reference to the Rules. Classification (or Certification as defined in clause 2.2) is an appraisalment given by the Society to the Client, at a certain date, following surveys by its surveyors on the level of compliance of the Unit to the Society's Rules and/or to Applicable Referential for the Services provided. They cannot be construed as an implied or express warranty of safety, fitness for the purpose, seaworthiness of the Unit or of its value for sale, insurance or chartering.
- 2.4 "Client" means the Party and/or its representative requesting the Services.
- 2.5 "Conditions" means the terms and conditions set out in the present document.
- 2.6 "Industry Practice" means international maritime and/or offshore industry practices.
- 2.7 "Intellectual Property" means all patents, rights to inventions, utility models, copyright and related rights, trade marks, logos, service marks, trade dress, business and domain names, rights in trade dress or get-up, rights in goodwill or to sue for passing off, unfair competition rights, rights in designs, rights in computer software, database rights, topography rights, moral rights, rights in confidential information (including know-how and trade secrets), methods and protocols for Services, and any other intellectual property rights, in each case whether capable of registration, registered or unregistered and including all applications for and renewals, reversions or extensions of such rights, and all similar or equivalent rights or forms of protection in any part of the world.
- 2.8 "Parties" means the Society and Client together.
- 2.9 "Party" means the Society or the Client.
- 2.10 "Register" means the public electronic register of ships updated regularly by the Society.
- 2.11 "Rules" means the Society's classification rules (available online on [veristar.com](http://veristar.com)), guidance notes and other documents. The Society's Rules take into account at the date of their preparation the state of currently available and proven technical minimum requirements but are not a standard or a code of construction neither a guide for maintenance, a safety handbook or a guide of professional practices, all of which are assumed to be known in detail and carefully followed at all times by the Client.
- 2.12 "Services" means the services set out in clauses 2.2 and 2.3 but also other services related to Classification and Certification such as, but not limited to: ship and company safety management certification, ship and port security certification, maritime labour certification, training activities, all activities and duties incidental thereto such as documentation on any supporting means, software, instrumentation, measurements, tests and trials on board. The Services are carried out by the Society according to the Rules and/or the Applicable Referential and to the Bureau Veritas' Code of Ethics. The Society shall perform the Services according to the applicable national and international standards and Industry Practice and always on the assumption that the Client is aware of such standards and Industry Practice.
- 2.13 "Society" means the classification society 'Bureau Veritas Marine & Offshore SAS', a company organized and existing under the laws of France, registered in Nanterre under number 821 131 844, or any other legal entity of Bureau Veritas Group as may be specified in the relevant contract, and whose main activities are Classification and Certification of ships or offshore units.
- 2.14 "Unit" means any ship or vessel or offshore unit or structure of any type or part of it or system whether linked to shore, river bed or sea bed or not, whether operated or located at sea or in inland waters or partly on land, including submarines, hovercrafts, drilling rigs, offshore installations of any type and of any purpose, their related and ancillary equipment, subsea or not, such as well head and pipelines, mooring legs and mooring points or otherwise as decided by the Society.

**3. SCOPE AND PERFORMANCE**

- 3.1 Subject to the Services requested and always by reference to the Rules, and/or to the Applicable Referential, the Society shall:
  - review the construction arrangements of the Unit as shown on the documents provided by the Client;
  - conduct the Unit surveys at the place of the Unit construction;
  - class the Unit and enter the Unit's class in the Society's Register;
  - survey the Unit periodically in service to note whether the requirements for the maintenance of class are met.The Client shall inform the Society without delay of any circumstances which may cause any changes on the conducted surveys or Services.
- 3.2 The Society will not:
  - declare the acceptance or commissioning of a Unit, nor its construction in conformity with its design, such activities remaining under the exclusive responsibility of the Unit's owner or builder;
  - engage in any work relating to the design, construction, production or repair checks, neither in the operation of the Unit or the Unit's trade, neither in any advisory services, and cannot be held liable on those accounts.

**4. RESERVATION CLAUSE**

- 4.1 The Client shall always: (i) maintain the Unit in good condition after surveys; (ii) present the Unit for surveys; and (iii) inform the Society in due time of any circumstances that may affect the given appraisalment of the Unit or cause to modify the scope of the Services.
- 4.2 Certificates are only valid if issued by the Society.
- 4.3 The Society has entire control over the Certificates issued and may at any time withdraw a Certificate at its entire discretion including, but not limited to, in the following situations: where the Client fails to comply in due time with instructions of the Society or where the Client fails to pay in accordance with clause 6.2 hereunder.
- 4.4 The Society may at times and at its sole discretion give an opinion on a design or any technical element that would 'in principle' be acceptable to the Society. This opinion shall not presume on the final issuance of any Certificate nor on its content in the event of the actual issuance of a Certificate. This opinion shall only be an appraisalment made by the Society which shall not be held liable for it.

**5. ACCESS AND SAFETY**

- 5.1 The Client shall give to the Society all access and information necessary for the efficient performance of the requested Services. The Client shall be the sole responsible for the conditions of presentation of the Unit for tests, trials and surveys and the conditions under which tests and trials are carried out. Any information, drawing, etc. required for the performance of the Services must be made available in due time.
- 5.2 The Client shall notify the Society of any relevant safety issue and shall take all necessary safety-related measures to ensure a safe work environment for the Society or any of its officers, employees, servants, agents or subcontractors and shall comply with all applicable safety regulations.

**6. PAYMENT OF INVOICES**

- 6.1 The provision of the Services by the Society, whether complete or not, involves, for the part carried out, the payment of fees thirty (30) days upon issuance of the invoice.
- 6.2 Without prejudice to any other rights hereunder, in case of Client's payment default, the Society shall be entitled to charge, in addition to the amount not properly paid, interest equal to twelve (12) months LIBOR plus two (2)

per-cent as of due date calculated on the number of days such payment is delinquent. The Society shall also have the right to withhold Certificates and other documents and/or to suspend or revoke the validity of Certificates.

- 6.3 In case of dispute on the invoice amount, the undisputed portion of the invoice shall be paid and an explanation on the dispute shall accompany payment so that action can be taken to resolve the dispute.

**7. LIABILITY**

- 7.1 The Society bears no liability for consequential loss. For the purpose of this clause consequential loss shall include, without limitation:
  - Indirect or consequential loss;
  - Any loss and/or deferral of production, loss of product, loss of use, loss of bargain, loss of revenue, loss of profit or anticipated profit, loss of business and business interruption, in each case whether direct or indirect.The Client shall defend, release, save, indemnify, defend and hold harmless the Society from the Client's own consequential loss regardless of cause.
- 7.2 Except in case of wilful misconduct of the Society, death or bodily injury caused by the Society's negligence and any other liability that could not be, by law, limited, the Society's maximum liability towards the Client is limited to one hundred and fifty per-cent (150%) of the price paid by the Client to the Society for the Services having caused the damage. This limit applies to any liability of whatsoever nature and howsoever arising, including fault by the Society, breach of contract, breach of warranty, tort, strict liability, breach of statute.
- 7.3 All claims shall be presented to the Society in writing within three (3) months of the completion of Services' performance or (if later) the date when the events which are relied on were first discovered by the Client. Any claim not so presented as defined above shall be deemed waived and absolutely time barred.

**8. INDEMNITY CLAUSE**

- 8.1 The Client shall defend, release, save, indemnify and hold harmless the Society from and against any and all claims, demands, lawsuits or actions for damages, including legal fees, for harm or loss to persons and/or property tangible, intangible or otherwise which may be brought against the Society, incidental to, arising out of or in connection with the performance of the Services (including for damages arising out of or in connection with opinions delivered according to clause 4.4 above) except for those claims caused solely and completely by the gross negligence of the Society, its officers, employees, servants, agents or subcontractors.

**9. TERMINATION**

- 9.1 The Parties shall have the right to terminate the Services (and the relevant contract) for convenience after giving the other Party thirty (30) days' written notice, and without prejudice to clause 6 above.
- 9.2 The Services shall be automatically and immediately terminated in the event the Client can no longer establish any form of interest in the Unit (e.g. sale, scrapping).
- 9.3 The Classification granted to the concerned Unit and the previously issued Certificates shall remain valid until the date of effect of the termination notice issued, or immediately in the event of termination under clause 9.2, subject to compliance with clause 4.1 and 6 above.
- 9.4 In the event where, in the reasonable opinion of the Society, the Client is in breach, or is suspected to be in breach of clause 16 of the Conditions, the Society shall have the right to terminate the Services (and the relevant contracts associated) with immediate effect.

**10. FORCE MAJEURE**

- 10.1 Neither Party shall be responsible or liable for any failure to fulfil any term or provision of the Conditions if and to the extent that fulfillment has been delayed or temporarily prevented by a force majeure occurrence without the fault or negligence of the Party affected and which, by the exercise of reasonable diligence, the said Party is unable to provide against.
- 10.2 For the purpose of this clause, force majeure shall mean any circumstance not being within a Party's reasonable control including, but not limited to: acts of God, natural disasters, epidemics or pandemics, wars, terrorist attacks, riots, sabotages, impositions of sanctions, embargoes, nuclear, chemical or biological contaminations, laws or action taken by a government or public authority, quotas or prohibition, expropriations, destructions of the worksite, explosions, fires, accidents, any labour or trade disputes, strikes or lockouts.

**11. CONFIDENTIALITY**

- 11.1 The documents and data provided to or prepared by the Society in performing the Services, and the information made available to the Society, will be treated as confidential except where the information:
  - is properly and lawfully in the possession of the Society;
  - is already in possession of the public or has entered the public domain, other than through a breach of this obligation;
  - is acquired or received independently from a third party that has the right to disseminate such information;
  - is required to be disclosed under applicable law or by a governmental order, decree, regulation or rule or by a stock exchange authority (provided that the receiving Party shall make all reasonable efforts to give prompt written notice to the disclosing Party prior to such disclosure).
- 11.2 The Parties shall use the confidential information exclusively within the framework of their activity underlying these Conditions.
- 11.3 Confidential information shall only be provided to third parties with the prior written consent of the other Party. However, such prior consent shall not be required when the Society provides the confidential information to a subsidiary.
- 11.4 Without prejudice to sub-clause 11.1, the Society shall have the right to disclose the confidential information if required to do so under regulations of the International Association of Classification Societies (IACS) or any statutory obligations.

**12. INTELLECTUAL PROPERTY**

- 12.1 Each Party exclusively owns all rights to its Intellectual Property created before or after the commencement date of the Conditions and whether or not associated with any contract between the Parties.
- 12.2 The Intellectual Property developed by the Society for the performance of the Services including, but not limited to drawings, calculations, and reports shall remain the exclusive property of the Society.

**13. ASSIGNMENT**

- 13.1 The contract resulting from to these Conditions cannot be assigned or transferred by any means by a Party to any third party without the prior written consent of the other Party.
- 13.2 The Society shall however have the right to assign or transfer by any means the said contract to a subsidiary of the Bureau Veritas Group.

**14. SEVERABILITY**

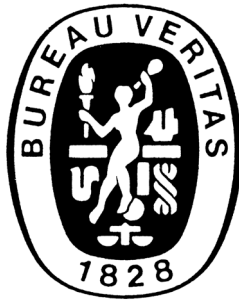
- 14.1 Invalidation of one or more provisions does not affect the remaining provisions.
- 14.2 Definitions herein take precedence over other definitions which may appear in other documents issued by the Society.
- 14.3 In case of doubt as to the interpretation of the Conditions, the English text shall prevail.

**15. GOVERNING LAW AND DISPUTE RESOLUTION**

- 15.1 These Conditions shall be construed in accordance with and governed by the laws of England and Wales.
- 15.2 Any dispute shall be finally settled under the Rules of Arbitration of the Maritime Arbitration Chamber of Paris ("CAM"), which rules are deemed to be incorporated by reference into this clause. The number of arbitrators shall be three (3). The place of arbitration shall be Paris (France). The Parties agree to keep the arbitration proceedings confidential.
- 15.3 Notwithstanding clause 15.2, disputes relating to the payment of the Society's invoices may be submitted by the Society to the *Tribunal de Commerce de Nanterre*, France, or to any other competent local Court, at the Society's entire discretion.

**16. PROFESSIONAL ETHICS**

- 16.1 Each Party shall conduct all activities in compliance with all laws, statutes, rules, economic and trade sanctions (including but not limited to US sanctions and EU sanctions) and regulations applicable to such Party including but not limited to: child labour, forced labour, collective bargaining, discrimination, abuse, working hours and minimum wages, anti-bribery, anti-corruption, copyright and trademark protection, personal data protection (<https://personaldataprotection.bureauveritas.com/prv-acvpolicy>).
- Each of the Parties warrants that neither it, nor its affiliates, has made or will make, with respect to the matters provided for hereunder, any offer, payment, gift or authorization of the payment of any money directly or indirectly, to or for the use or benefit of any official or employee of the government, political party, official, or candidate.
- 16.2 In addition, the Client shall act consistently with the Bureau Veritas' Code of Ethics and, when applicable, Business Partner Code of Conduct both available at <https://group.bureauveritas.com/group/corporate-social-responsibility/operational-excellence>.



# RULES FOR THE CLASSIFICATION OF SHIPS

## Part F Additional Class Notations

### Chapters 1 2 3 4 5 6 7 8 9 10 11

---

Chapter 1	VERISTAR SYSTEM (STAR)
Chapter 2	AVAILABILITY OF MACHINERY (AVM)
Chapter 3	AUTOMATION SYSTEMS (AUT)
Chapter 4	INTEGRATED SHIP SYSTEMS (SYS)
Chapter 5	MONITORING EQUIPMENT (MON)
Chapter 6	COMFORT ON BOARD (COMF)
Chapter 7	REFRIGERATING INSTALLATIONS (REF)
Chapter 8	ICE CLASS (ICE)
Chapter 9	POLLUTION PREVENTION (CLEANSHIP)
Chapter 10	PROTECTION AGAINST CHEMICAL, BIOLOGICAL, RADIOLOGICAL AND NUCLEAR RISK
Chapter 11	OTHER ADDITIONAL CLASS NOTATIONS

**The English wording of these rules take precedence over editions in other languages.**

**Unless otherwise specified, these rules apply to ships for which contracts are signed after July 1st, 2021. The Society may refer to the contents hereof before July 1st, 2021, as and when deemed necessary or appropriate.**

# CHAPTER 1

## VERISTAR SYSTEM (STAR)

### Section 1 VeriSTAR-HULL, VeriSTAR-HULL CM and VeriSTAR-HULL SIS

1	General	47
1.1	Application	
1.2	Scope	
2	Assignment of the notation	47
2.1	VeriSTAR-Hull	
2.2	VeriSTAR-HULL CM	
2.3	VeriSTAR-Hull SIS	
2.4	Acceptance criteria for thickness measurements	

### Section 2 Star-Hull

1	General	49
1.1	Principles	
1.2	Conditions for the assignment of the notation	
2	Documentation to be submitted	49
2.1	Plans and documents to be submitted	
2.2	Inspection and Maintenance Plan (IMP)	
3	Inspection and Maintenance Plan (IMP)	50
3.1	Minimum requirements	
3.2	General scope of IMP	
3.3	Periodicity of inspections	
3.4	Extent of inspections	
3.5	Inspection reports	
3.6	Changes to Inspection and Maintenance Plan	
4	Acceptance criteria	53
4.1	Coating assessment	
4.2	Sacrificial anode condition	
4.3	Thickness measurements	
4.4	Pitting	
4.5	Fractures	

### Section 3 Star-Mach, Star-Mach SIS

1	General	56
1.1	Application	
1.2	Definitions	
1.3	Scope	
1.4	Objectives	
2	Assignment of the notation	57
2.1	Documentation to be submitted	
2.2	STAR-MACH	
2.3	STAR-MACH SIS	

## Section 4 Star-Regas

1	General	59
1.1	Application	
1.2	Scope	
1.3	Objectives	
2	Assignment of the notation	59
2.1	Documentation to be submitted	
2.2	STAR-REGAS	

## Section 5 Star-Cargo

1	General	60
1.1	Application	
1.2	Scope	
1.3	Objectives	
2	Assignment of the notation	60
2.1	Documentation to be submitted	
2.2	STAR-CARGO	

## Appendix 1 Acceptance Criteria for Isolated Areas of Items

1	General	61
1.1	Application	

## Appendix 2 Acceptance Criteria for Isolated Items

1	Partial safety factors	64
1.1	General	
1.2	Partial safety factors based on the increased knowledge of the structure	
2	Acceptance criteria for plating	64
2.1	Application	
2.2	Renewal thicknesses	
3	Acceptance criteria for ordinary stiffeners	66
3.1	Application	
3.2	Renewal scantlings	
4	Acceptance criteria for primary supporting members	68
4.1	Application	
4.2	Work ratios	
4.3	Renewal scantlings	

## Appendix 3 Acceptance Criteria for Zones

1	General	70
1.1	Application	

## Appendix 4 Owner's Hull Inspection Reports

1	General	71
	1.1	
2	Report for inspection of spaces	71
	2.1 General	
	2.2 Identification data	
	2.3 Summary of findings and repairs	
	2.4 Details of findings and repairs	
	2.5 Attached documentation	
3	Report for inspection of equipment	73
	3.1 General	
	3.2 Identification data	
	3.3 Detailed report	
	3.4 Attached documentation	

# CHAPTER 2

## AVAILABILITY OF MACHINERY (AVM)

### Section 1 Alternative Propulsion System (AVM-APS)

<b>1</b>	<b>General</b>	<b>77</b>
	1.1 Application	
	1.2 Definitions	
	1.3 Documentation to be submitted	
<b>2</b>	<b>General design requirements</b>	<b>78</b>
	2.1 Principle	
	2.2 Alternative propulsion machinery	
<b>3</b>	<b>Special arrangements</b>	<b>78</b>
	3.1 Propulsion system	
	3.2 Systems for cooling, lubrication, fuel supply, air starting, monitoring and control	
	3.3 Electrical installations	
<b>4</b>	<b>Tests on board</b>	<b>79</b>
	4.1 Operational tests	
	4.2 Sea trials	

### Section 2 Duplicated Propulsion System (AVM-DPS)

<b>1</b>	<b>General</b>	<b>80</b>
	1.1 Application	
	1.2 Definitions	
	1.3 Documents to be submitted	
<b>2</b>	<b>General design requirements</b>	<b>81</b>
	2.1 Principle	
	2.2 Propulsion machinery	
	2.3 Steering machinery	
<b>3</b>	<b>Specific design requirements</b>	<b>82</b>
	3.1 Propulsion machinery	
	3.2 Steering systems	
	3.3 Electrical installations	
	3.4 Automation	
<b>4</b>	<b>Additional requirements for ships having the notation AVM-DPS/NS</b>	<b>82</b>
	4.1 Propulsion machinery	
	4.2 Electrical installations	
<b>5</b>	<b>Tests on board</b>	<b>82</b>
	5.1 Operating tests	
	5.2 Sea trials	



### **Section 3 Independent Propulsion Systems (AVM-IPS)**

<b>1</b>	<b>General</b>	<b>83</b>
	1.1 Application	
	1.2 Definitions	
	1.3 Documents to be submitted	
<b>2</b>	<b>General design requirements</b>	<b>84</b>
	2.1 Principle	
	2.2 Compartment arrangement	
	2.3 Propulsion machinery	
	2.4 Steering machinery	
	2.5 Electrical power plant	
<b>3</b>	<b>Specific design requirements</b>	<b>85</b>
	3.1 Propulsion machinery	
	3.2 Steering systems	
	3.3 Electrical installations	
	3.4 Automation	
<b>4</b>	<b>Additional requirements for ships having the notation AVM-IPS/NS</b>	<b>86</b>
	4.1 Propulsion machinery	
	4.2 Electrical installations	
<b>5</b>	<b>Tests on board</b>	<b>86</b>
	5.1 Operating tests	
	5.2 Sea trials	

### **Section 4 Fire Mitigation for Main Diesel-Generator Rooms (AVM-FIRE)**

<b>1</b>	<b>General</b>	<b>87</b>
	1.1 Application	
	1.2 Definitions	
	1.3 Documents to be submitted	
<b>2</b>	<b>General design requirements</b>	<b>88</b>
	2.1 Principle	
	2.2 Electrical power plant	
	2.3 Propulsion and steering	
	2.4 Fire protection and detection	
<b>3</b>	<b>Tests on board</b>	<b>89</b>
	3.1 Operating tests	
	3.2 Sea trials	

### **Appendix 1 Procedures for Failure Modes and Effect Analysis**

<b>1</b>	<b>General</b>	<b>90</b>
	1.1 Introduction	
	1.2 Objectives	
	1.3 Sister ships	
	1.4 FMEA basics	
	1.5 FMEA analysis	

<b>2</b>	<b>FMEA performance</b>	<b>91</b>
2.1	Procedures	
2.2	System definition	
2.3	Development of system block diagram	
2.4	Identification of failure modes, causes and effects	
2.5	Failure effects	
2.6	Failure detection	
2.7	Corrective measures	
2.8	Use of probability concept	
2.9	Documentation	
<b>3</b>	<b>Tests and reporting</b>	<b>94</b>
3.1	Test program	
3.2	Reporting	
<b>4</b>	<b>Probabilistic concept</b>	<b>94</b>
4.1	General	
4.2	Occurrences	
4.3	Probability of occurrences	
4.4	Effects	
4.5	Safety level	
4.6	Numerical values	

# CHAPTER 3

## AUTOMATION SYSTEMS (AUT)

### Section 1 Unattended Machinery Spaces (AUT-UMS)

1	General	99
	1.1 Application	
	1.2 Exemptions	
	1.3 Communication system	
2	Documentation	100
	2.1 Documents to be submitted	
3	Fire and flooding precautions	100
	3.1 Fire prevention	
	3.2 Fire detection	
	3.3 Fire fighting	
	3.4 Protection against flooding	
4	Control of machinery	101
	4.1 General	
	4.2 Diesel propulsion plants	
	4.3 Steam propulsion plants	
	4.4 Gas turbine propulsion plants	
	4.5 Gas-only and dual fuel engines	
	4.6 Electrical propulsion plant	
	4.7 Shafting, clutches, CPP, gears	
	4.8 Auxiliary system	
	4.9 Control of electrical installation	
5	Alarm system	118
	5.1 General	
	5.2 Alarm system design	
	5.3 Machinery alarm system	
	5.4 Alarm system on navigating bridge	
6	Safety systems	118
	6.1 General	
7	Testing	119
	7.1 General	
	7.2 Specific requirement for ships fitted with engine using both low-flashpoint gaseous fuels and fuel oil as fuel	

### Section 2 Centralised Control Station (AUT-CCS)

1	General	120
	1.1 Application	
	1.2 Exemptions	
	1.3 Communication system	
2	Documentation	120
	2.1 Documents to be submitted	

<b>3</b>	<b>Fire and flooding precautions</b>	<b>120</b>
	3.1 General	
<b>4</b>	<b>Control of machinery</b>	<b>120</b>
	4.1 Propulsion plant operation	
	4.2 Control position location	
<b>5</b>	<b>Alarm system</b>	<b>121</b>
	5.1 General	
<b>6</b>	<b>Safety system</b>	<b>121</b>
	6.1 General	
<b>7</b>	<b>Testing</b>	<b>121</b>
	7.1 Tests after completion	
	7.2 Sea trials	

### **Section 3 Automated Operation in Port (AUT-PORT)**

<b>1</b>	<b>General</b>	<b>122</b>
	1.1 Application	
	1.2 Exemptions	
	1.3 Communication system	
<b>2</b>	<b>Documentation</b>	<b>122</b>
	2.1 Documents to be submitted	
<b>3</b>	<b>Fire and flooding precautions</b>	<b>122</b>
	3.1 general	
<b>4</b>	<b>Control of machinery</b>	<b>122</b>
	4.1 Plant operation	
<b>5</b>	<b>Alarm system</b>	<b>122</b>
	5.1 General	
<b>6</b>	<b>Testing</b>	<b>123</b>
	6.1 Tests after completion	

### **Section 4 Integrated Machinery Spaces (AUT-IMS)**

<b>1</b>	<b>General</b>	<b>124</b>
	1.1 Application	
<b>2</b>	<b>Documentation</b>	<b>124</b>
	2.1 Documents to be submitted	
<b>3</b>	<b>Fire and flooding precautions</b>	<b>124</b>
	3.1 Fire prevention	
	3.2 Fire detection	
	3.3 Fire fighting	
	3.4 Protection against flooding	

<b>4</b>	<b>Integrated computer based systems</b>	<b>125</b>
4.1	General	
4.2	Design requirements	
<b>5</b>	<b>Construction requirements</b>	<b>125</b>
5.1	Electrical and electronic construction requirements	
5.2	Pneumatic construction requirements	
5.3	Hydraulic construction requirements	
<b>6</b>	<b>Control of machinery</b>	<b>126</b>
6.1	General	
6.2	Diesel propulsion plants	
6.3	Steam propulsion plants	
6.4	Gas turbine propulsion plant	
6.5	Electric propulsion plant	
6.6	Shafting, clutches, CPP, gears	
6.7	Auxiliary systems	
6.8	Control of electrical installation	
<b>7</b>	<b>Testing</b>	<b>132</b>
7.1	Additional testing	
7.2	Maintenance equipment	

# CHAPTER 4

## INTEGRATED SHIP SYSTEMS (SYS)

### Section 1 Centralised Navigation Equipment (SYS-NEQ)

<b>1</b>	<b>General</b>	<b>135</b>
1.1	Application	
1.2	Operational assumptions	
1.3	Regulations, guidelines, standards	
1.4	Definitions	
<b>2</b>	<b>Documentation</b>	<b>136</b>
2.1	Documents to be submitted	
<b>3</b>	<b>Bridge layout</b>	<b>137</b>
3.1	General	
<b>4</b>	<b>Bridge instrumentation and controls</b>	<b>137</b>
4.1	General	
4.2	Safety of navigation: collision-grounding	
4.3	Position fixing	
4.4	Controls - Communication	
<b>5</b>	<b>Design and reliability</b>	<b>139</b>
5.1	General	
5.2	Power supply	
5.3	Environmental conditions	
<b>6</b>	<b>Prevention of accidents caused by operator's unfitness</b>	<b>140</b>
6.1	Field of vision	
6.2	Alarm/warning transfer system - Communications	
6.3	Bridge layout	
<b>7</b>	<b>Ergonomical recommendations</b>	<b>140</b>
7.1	Lighting	
7.2	Noise level	
7.3	Vibration level	
7.4	Wheelhouse space heating/cooling	
7.5	Navigator's safety	
<b>8</b>	<b>Testing</b>	<b>141</b>
8.1	Tests	

### Section 2 Integrated Bridge Systems (SYS-IBS)

<b>1</b>	<b>General</b>	<b>142</b>
1.1	Application	
1.2	Reference Regulations	
1.3	Definitions	
1.4	Abbreviations	

<b>2</b>	<b>Documentation</b>	<b>144</b>
	2.1 Documents to be submitted	
<b>3</b>	<b>General requirements</b>	<b>144</b>
	3.1 General	
	3.2 Integration	
	3.3 Data exchange	
	3.4 Failure analysis	
	3.5 Quality assurance	
<b>4</b>	<b>Operational requirements</b>	<b>146</b>
	4.1 Human factors	
	4.2 Functionality	
	4.3 Training	
<b>5</b>	<b>Technical requirements</b>	<b>147</b>
	5.1 Sensors	
	5.2 Alarm management	
	5.3 Human factors	
	5.4 Power interruptions and shutdown	
	5.5 Power supply	
<b>6</b>	<b>Testing</b>	<b>149</b>
	6.1 Introduction	
	6.2 General requirements	
	6.3 Operational requirements	
	6.4 Technical requirements	

### **Section 3 Communication System (SYS-COM)**

<b>1</b>	<b>General</b>	<b>152</b>
	1.1 Application	
	1.2 References	
	1.3 Definition	
<b>2</b>	<b>Documentation</b>	<b>153</b>
	2.1 Documents to be submitted	
<b>3</b>	<b>Ships assigned with additional class notation CYBER SECURE</b>	<b>154</b>
	3.1 General	
<b>4</b>	<b>Design and operation of the communication system</b>	<b>154</b>
	4.1 Communication	
	4.2 Quality assurance	
	4.3 Safety	
	4.4 Security	
	4.5 Operation	
<b>5</b>	<b>Onboard testing</b>	<b>155</b>
	5.1	
<b>6</b>	<b>Security recommendations</b>	<b>156</b>
	6.1	

# CHAPTER 5

## MONITORING EQUIPMENT (MON)

### Section 1 Hull Stress and Motion Monitoring (MON-HULL)

<b>1</b>	<b>General</b>	<b>158</b>
1.1	Application	
1.2	Documentation	
<b>2</b>	<b>Sensors design</b>	<b>158</b>
2.1	General	
2.2	Measurements ranges and tolerances	
2.3	On-site calibration of sensors	
2.4	Environmental and EMC requirements	
<b>3</b>	<b>System design</b>	<b>159</b>
3.1	General	
3.2	Data processing	
3.3	Data displaying	
3.4	Alarms	
3.5	Data storage	
3.6	Exploitation of stored data	
3.7	Checking facility	
3.8	Power supply	
<b>4</b>	<b>Installation and testing</b>	<b>160</b>
4.1	General	
4.2	Installation of sensors	
4.3	Testing of Hull Monitoring System	

### Section 2 Shaft Monitoring (MON-SHAFT)

<b>1</b>	<b>General</b>	<b>161</b>
1.1	Applicability of MON-SHAFT notation	
<b>2</b>	<b>Requirements for oil lubricated tailshaft bearings</b>	<b>161</b>
2.1	Arrangement	
2.2	Lubricating oil analysis	
<b>3</b>	<b>Requirements for water lubricated tailshaft bearings</b>	<b>161</b>
3.1	General requirements	
3.2	Additional requirements for forced water lubrication systems	



# CHAPTER 6

## COMFORT ON BOARD (COMF)

### Section 1 General Requirements

1	General	165
	1.1 Application	
	1.2 Basic principles	
	1.3 Regulations, Standards	
	1.4 Definitions	
	1.5 Document to be submitted	
2	Conditions of attribution	166
	2.1 Measurements	
	2.2 Determination of comfort rating number	
	2.3 Measuring locations	
3	Testing conditions	167
	3.1 General	
	3.2 Harbour test conditions	
	3.3 Sea trial conditions	

### Section 2 Additional Requirements for Ships of Less than 1600 GT

1	General	169
	1.1 Application	
2	COMF-NOISE	169
	2.1 Measurement procedure	
	2.2 Noise levels	
	2.3 Sound insulation measurements	
3	COMF-VIB	169
	3.1 Measurement procedure	
	3.2 Vibration levels	

### Section 3 Additional Requirements for Ships Greater than or Equal to 1600 GT - Crew Areas

1	General	172
	1.1 Application	
2	COMF-NOISE	172
	2.1 Measurement procedure	
	2.2 Noise levels	
	2.3 Sound insulation measurements	
3	COMF-VIB	173
	3.1 Measurement procedure	
	3.2 Vibration levels	

## **Section 4 Additional Requirements for Ships Greater than or Equal to 1600 GT - Passenger Areas**

<b>1</b>	<b>General</b>	<b>175</b>
	1.1 Application	
<b>2</b>	<b>COMF-NOISE</b>	<b>175</b>
	2.1 Measurement procedure	
	2.2 Noise levels	
	2.3 Sound insulation measurements	
	2.4 Impact measurements	
<b>3</b>	<b>COMF-VIB</b>	<b>176</b>
	3.1 Measurement procedure	
	3.2 Vibration levels	

## **Section 5 Additional Requirements for Yachts**

<b>1</b>	<b>General</b>	<b>179</b>
	1.1 Application	
<b>2</b>	<b>COMF-NOISE</b>	<b>179</b>
	2.1 Measurement procedure	
	2.2 Noise levels	
	2.3 Sound insulation measurements	
	2.4 Impact measurements	
<b>3</b>	<b>COMF-VIB</b>	<b>180</b>
	3.1 Measurement procedure	
	3.2 Vibration levels	
<b>4</b>	<b>COMF +</b>	<b>181</b>
	4.1 Application	
	4.2 Data processing and analysis	
	4.3 Measurement procedure	
	4.4 COMF + Sound insulation index	
	4.5 COMF + Impact index	
	4.6 COMF + Emergence	
	4.7 COMF + intermittent noise	
	4.8 COMF + intelligibility	

# CHAPTER 7

## REFRIGERATING INSTALLATIONS (REF)

### Section 1 General Requirements

<b>1</b>	<b>General</b>	<b>185</b>
	1.1 Application	
	1.2 Temperature conditions	
	1.3 Definitions	
<b>2</b>	<b>Design criteria</b>	<b>186</b>
	2.1 Reference conditions	
<b>3</b>	<b>Documentation</b>	<b>186</b>
	3.1 Refrigerating installations	
	3.2 Controlled atmosphere installations	
<b>4</b>	<b>General technical requirements</b>	<b>186</b>
	4.1 Refrigeration of chambers	
	4.2 Defrosting	
	4.3 Prime movers and sources of power	
	4.4 Pumps	
	4.5 Sea connections	
	4.6 Refrigerating machinery spaces	
	4.7 Exemptions for small plants	
	4.8 Personnel safety	
<b>5</b>	<b>Refrigerated chambers</b>	<b>188</b>
	5.1 Construction of refrigerated chambers	
	5.2 Penetrations	
	5.3 Access to refrigerated spaces	
	5.4 Insulation of refrigerated chambers	
	5.5 Protection of insulation	
	5.6 Miscellaneous requirements	
	5.7 Installation of the insulation	
	5.8 Drainage of refrigerated spaces	
<b>6</b>	<b>Refrigerants</b>	<b>190</b>
	6.1 General	
	6.2 Rated working pressures	
<b>7</b>	<b>Refrigerating machinery and equipment</b>	<b>191</b>
	7.1 General requirements for prime movers	
	7.2 Common requirements for compressors	
	7.3 Reciprocating compressors	
	7.4 Screw compressor bearings	
	7.5 Pressure vessels	
	7.6 General requirements for piping	
	7.7 Accessories	
	7.8 Refrigerating plant overpressure protection	
<b>8</b>	<b>Specific requirements for direct and indirect refrigerating systems</b>	<b>193</b>
	8.1 Specific requirements for refrigerating systems	
	8.2 Specific requirements for air cooling systems and distribution and renewal of air in cargo spaces	

<b>9</b>	<b>Instrumentation, alarm, monitoring</b>	<b>194</b>
	9.1 General	
	9.2 Instrumentation, alarm and monitoring arrangement	
<b>10</b>	<b>Material tests, inspection and testing, certification</b>	<b>195</b>
	10.1 Material testing	
	10.2 Shop tests	
	10.3 Pressure tests at the workshop	
	10.4 Thermometers and manometers	
	10.5 Shipboard tests	
	10.6 Defrosting system	

## **Section 2 Additional Requirements for Notation REF-CARGO**

<b>1</b>	<b>General</b>	<b>197</b>
	1.1 Application	
	1.2 Refrigeration of cargo spaces	
	1.3 Heating	
<b>2</b>	<b>Refrigerated cargo spaces</b>	<b>197</b>
	2.1 Insulation	
<b>3</b>	<b>Instrumentation</b>	<b>197</b>
	3.1 Thermometers in cargo spaces	
<b>4</b>	<b>Additional requirements for AIR-CONT notation</b>	<b>198</b>
	4.1 General	
	4.2 Controlled atmosphere cargo spaces and adjacent spaces	
	4.3 Gas systems	
	4.4 Miscellaneous equipment	
	4.5 Gas detection and monitoring equipment	
	4.6 Instrumentation, alarm and monitoring arrangement	
	4.7 Safety	
	4.8 Tests and trials	
<b>5</b>	<b>Additional requirements for notations PRECOOLING and QUICKFREEZE</b>	<b>203</b>
	5.1 General	
	5.2 Shipboard tests	

## **Section 3 Additional Requirements for Notation REF-CONT**

<b>1</b>	<b>General</b>	<b>204</b>
	1.1 Application	
<b>2</b>	<b>Refrigerating plants supplying refrigerated air to containers</b>	<b>204</b>
	2.1 Definitions	
	2.2 Cold distribution	
	2.3 Equipment and systems	
	2.4 Thermometers	
	2.5 Workshop and shipboard inspections and tests	
	2.6 Temperature measuring and recording devices	
	2.7 Shipboard tests	

<b>3</b>	<b>Ships supplying electrical power to self-refrigerated containers</b>	<b>207</b>
3.1	Electrical equipment	
3.2	Installation of containers	

---

## **Section 4 Additional Requirements for Notation REF-STORE**

<b>1</b>	<b>General</b>	<b>208</b>
1.1	Application	

---

# CHAPTER 8

## ICE CLASS (ICE)

### Section 1 General

<b>1</b>	<b>General</b>	<b>211</b>
	1.1 Application	
	1.2 Owner's responsibility	
	1.3 Documents to be submitted	
<b>2</b>	<b>Ice class draughts and ice thickness</b>	<b>211</b>
	2.1 Definitions	
	2.2 Draught limitations in ice	
	2.3 Ice thickness	
<b>3</b>	<b>Output of propulsion machinery</b>	<b>212</b>
	3.1 Required engine output for ICE CLASS IA SUPER, ICE CLASS IA, ICE CLASS IB and ICE CLASS IC	

### Section 2 Hull and Stability

<b>1</b>	<b>General</b>	<b>215</b>
	1.1 Application	
	1.2 Hull regions	
	1.3 Ice strengthened area	
<b>2</b>	<b>Structure design principles</b>	<b>216</b>
	2.1 General framing arrangement	
	2.2 Transverse framing arrangement	
	2.3 Bilge keels	
<b>3</b>	<b>Design loads</b>	<b>217</b>
	3.1 General	
	3.2 Ice loads	
<b>4</b>	<b>Hull scantlings</b>	<b>219</b>
	4.1 Gross scantlings	
	4.2 Plating	
	4.3 Ordinary stiffeners	
	4.4 Primary supporting members	
<b>5</b>	<b>Other structures</b>	<b>221</b>
	5.1 Application	
	5.2 Fore part	
	5.3 Aft part	
	5.4 Deck strips and hatch covers	
	5.5 Sidescuttles and freeing ports	
<b>6</b>	<b>Hull outfitting</b>	<b>222</b>
	6.1 Rudders and steering arrangements	
	6.2 Bulwarks	

<b>7</b>	<b>Additional class notations YOUNG ICE 1 and YOUNG ICE 2</b>	<b>222</b>
7.1	Area to be strengthened	
7.2	Design loads	
7.3	Plating	
7.4	Ordinary stiffeners and primary supporting members	
7.5	Sidescuttles and freeing ports	

### **Section 3 Machinery**

<b>1</b>	<b>Requirements for propulsion machinery of the class notation ICE CLASS IA SUPER, ICE CLASS IA, ICE CLASS IB and ICE CLASS IC</b>	<b>225</b>
1.1	Scope	
1.2	Design ice conditions	
1.3	Materials	
1.4	Design loads	
1.5	Propeller blade design	
1.6	Controllable pitch propeller	
1.7	Propulsion line design	
1.8	Coupling	
1.9	Gear	
1.10	Chockfast calculation	
1.11	Azimuthing main propulsors	
<b>2</b>	<b>Requirements for propulsion machinery of ICE CLASS ID</b>	<b>243</b>
2.1	Ice torque	
2.2	Propellers	
2.3	Shafting	
<b>3</b>	<b>Miscellaneous requirements</b>	<b>245</b>
3.1	Starting arrangements	
3.2	Sea inlets, ballast systems and cooling water systems of machinery	
3.3	Steering gear	
3.4	Fire pumps	
3.5	Transverse thrusters	
3.6	Test and certification for propellers	

# CHAPTER 9

## POLLUTION PREVENTION (CLEANSHIP)

### Section 1 General Requirements

1	Scope and application	249
1.1	General	
1.2	Applicable rules and regulations	
2	Definitions and abbreviations	250
2.1	Definitions related to sea pollution	
2.2	Definitions related to air pollution	
2.3	Abbreviations	
3	Documents to be submitted and applicable standards	251
3.1	Documents to be submitted	
3.2	Modifications and additions	

### Section 2 Design Requirements for the Notations CLEANSHIP and CLEANSHIP SUPER

1	General	256
1.1	Application	
1.2	Documents to be submitted	
2	Design requirements for the additional class notation CLEANSHIP	256
2.1	Waste management	
2.2	Oily wastes	
2.3	Wastewaters	
2.4	Garbage and hazardous wastes	
2.5	Hull antifouling systems	
2.6	Prevention of pollution by oil spillage and leakage	
2.7	Refrigeration systems	
2.8	Fire-fighting systems	
2.9	Emission of nitrogen oxides (NO <sub>x</sub> )	
2.10	Emission of sulphur oxides (SO <sub>x</sub> )	
3	Additional design requirements for the additional class notation CLEANSHIP SUPER	261
3.1	Waste minimization and recycling program	
3.2	Oily wastes	
3.3	Wastewaters	
3.4	Food wastes	
3.5	Prevention of pollution by oil spillage and leakage	
3.6	Protection against oil pollution in the event of collision or grounding	
3.7	Prevention of air pollution	



### **Section 3 Design Requirements for the Pollution Prevention Notations other than CLEANSHIP and CLEANSHIP SUPER**

<b>1</b>	<b>General</b>	<b>263</b>
	1.1 Application	
	1.2 Documents to be submitted	
<b>2</b>	<b>Additional class notations AWT-A, AWT-B and AWT-A/B</b>	<b>263</b>
	2.1 Scope	
	2.2 Definitions and abbreviations	
	2.3 Design of the AWT plant	
<b>3</b>	<b>Additional class notation BWE</b>	<b>264</b>
	3.1 Scope	
	3.2 Design requirements	
<b>4</b>	<b>Additional class notation BWT</b>	<b>264</b>
	4.1 Scope	
	4.2 Design and installation requirements	
<b>5</b>	<b>Additional class notation GWT</b>	<b>264</b>
	5.1 Scope	
	5.2 Design of the grey water treatment plant	
<b>6</b>	<b>Additional class notation NDO-x days</b>	<b>265</b>
	6.1 Scope	
	6.2 Design requirements	
<b>7</b>	<b>Additional class notation NOX-x%</b>	<b>265</b>
	7.1 Scope	
	7.2 Design requirements	
<b>8</b>	<b>Additional class notation OWS-x ppm</b>	<b>266</b>
	8.1 Scope	
	8.2 Design requirements	
<b>9</b>	<b>Additional class notation SOX-x%</b>	<b>266</b>
	9.1 Scope	
	9.2 Design requirements	
<b>10</b>	<b>Additional class notation EGCS-SCRUBBER</b>	<b>266</b>
	10.1 Scope	
	10.2 Design and installation requirements	
<b>11</b>	<b>Notation CEMS</b>	<b>266</b>
	11.1 Scope	
	11.2 On-board emission measurement and monitoring equipment	
	11.3 Remote transmission of the parameters related to waste discharge and air emissions	

### **Section 4 Onboard Surveys**

<b>1</b>	<b>Application</b>	<b>268</b>
	1.1	

<b>2</b>	<b>Periodical tests and measurements done by the shipowner</b>	<b>268</b>
2.1	General	
2.2	Initial period	
2.3	Periodical tests after first year of service	
<b>3</b>	<b>Periodical surveys</b>	<b>269</b>
3.1	Initial survey	
3.2	Periodical survey	

# CHAPTER 10

## PROTECTION AGAINST CHEMICAL, BIOLOGICAL, RADIOLOGICAL AND NUCLEAR RISK

### Section 1 General

<b>1</b>	<b>General</b>	<b>273</b>
	1.1 Scope	
	1.2 Application	
	1.3 CBRN operation specification	
<b>2</b>	<b>Definitions and abbreviations</b>	<b>273</b>
	2.1 Citadel	
	2.2 CBRN	
	2.3 CBRN Mode	
	2.4 CBRN Operation	
	2.5 Collective protection system	
	2.6 Shelter	
	2.7 PPE	
<b>3</b>	<b>Documents to be submitted</b>	<b>274</b>
	3.1	

### Section 2 Ship Arrangement

<b>1</b>	<b>Citadel</b>	<b>275</b>
	1.1 Spaces to be included in the citadel	
	1.2 Spaces where explosive atmosphere may occur	
	1.3 Boundaries of the citadel	
	1.4 Openings in the citadel boundaries	
	1.5 Means of access to the citadel	
<b>2</b>	<b>CBRN Control station</b>	<b>275</b>
	2.1 Function	
	2.2 Location	
<b>3</b>	<b>Space for rescued people</b>	<b>275</b>
	3.1 Accommodation for rescued people	
	3.2 Means of escape	
<b>4</b>	<b>Shelter</b>	<b>276</b>
	4.1 Sheltered spaces	
	4.2 Openings in shelter boundary	
<b>5</b>	<b>Airlock</b>	<b>276</b>
	5.1 Arrangement	
	5.2 Doors	
	5.3 Purging	
<b>6</b>	<b>Cleansing station</b>	<b>276</b>
	6.1 Arrangement	
	6.2 Doors	

<b>7</b>	<b>Machinery space arrangement</b>	<b>276</b>
7.1	Allowable arrangements for engine room and internal combustion machinery spaces	
7.2	Machinery space included in the citadel	
7.3	Sheltered machinery space	
7.4	Unprotected machinery space	
7.5	Fire protection	
7.6	Engine room cooling	
<b>8</b>	<b>Superstructure design</b>	<b>277</b>
8.1	Precautions for decontamination	
<b>9</b>	<b>Marking</b>	<b>278</b>
9.1	Openings	
9.2	Equipment	

### **Section 3 CBRN Protection**

<b>1</b>	<b>Detection system</b>	<b>279</b>
1.1	Detection	
1.2	Alarm and monitoring	
<b>2</b>	<b>Collective Protection system</b>	<b>279</b>
2.1	Citadel ventilation	
2.2	Ventilation of machinery spaces included in the citadel	
2.3	CBRN Protection plant	
2.4	Airlocks and cleansing stations	
<b>3</b>	<b>Personal protective equipment (PPE)</b>	<b>280</b>
3.1	General	
3.2	Self-contained breathing apparatus	
<b>4</b>	<b>Monitoring and Controls</b>	<b>281</b>
4.1		
<b>5</b>	<b>Onboard procedures</b>	<b>281</b>
5.1	CBRN operation manual	
5.2	Fire control plan	
5.3	Fire procedures	

### **Section 4 Piping and Electrical Equipment**

<b>1</b>	<b>Piping systems</b>	<b>283</b>
1.1	General	
1.2	Scupper and bilge systems	
1.3	Air, sounding and overflow pipes	
<b>2</b>	<b>Electrical equipment</b>	<b>283</b>
2.1	Environmental protection	
2.2	Emergency source of power	

## **Section 5 Pre-Wetting and Washdown System**

<b>1</b>	<b>General</b>	<b>284</b>
1.1	Application	
1.2	Ventilation openings	
<b>2</b>	<b>Pre-wetting and washdown system</b>	<b>284</b>
2.1	System arrangement	
2.2	System equipment	

## **Section 6 Inspection and Testing**

<b>1</b>	<b>Construction testing</b>	<b>285</b>
1.1	General	
1.2	Tightness test	
1.3	Collective protection ventilation test	
1.4	CBRN detection test	
1.5	Pre-wetting and wash down test	

# CHAPTER 11

## OTHER ADDITIONAL CLASS NOTATIONS

### Section 1 Strengthened Bottom (STRENGTHBOTTOM)

1	General	289
1.1	Application	
2	Primary supporting members arrangement	289
2.1	Ships with a longitudinally framed bottom	
2.2	Ships with a transversely framed bottom	
3	Bottom scantlings	289
3.1	Plating	
3.2	Ordinary stiffeners	
3.3	Primary supporting members	

### Section 2 Grab Loading (GRABLOADING)

1	General	291
1.1	Application	
2	Scantlings	291
2.1	Inner bottom plating	

### Section 3 In-Water Survey Arrangements (INWATERSURVEY)

1	General	292
1.1	Application	
1.2	Documentation to be submitted	
2	Structure design principles	292
2.1	Marking	
2.2	Rudder arrangements	
2.3	Tailshaft arrangements	
3	Sea inlets and cooling water systems of machinery	292
3.1		

### Section 4 Single Point Mooring (SPM)

1	General	293
1.1	Application	
2	Documentation	293
2.1	Documentation for approval	
2.2	Documentation for information	

<b>3</b>	<b>General arrangement</b>	<b>293</b>
	3.1 General provision	
	3.2 Typical layout	
	3.3 Equipment	
<b>4</b>	<b>Number and safe working load of chain stoppers</b>	<b>294</b>
	4.1 General	
<b>5</b>	<b>Mooring components</b>	<b>294</b>
	5.1 Bow chain stopper	
	5.2 Bow fairleads	
	5.3 Pedestal roller fairleads	
	5.4 Winches or capstans	
<b>6</b>	<b>Supporting hull structures</b>	<b>296</b>
	6.1 General	
<b>7</b>	<b>Strength criteria</b>	<b>296</b>
	7.1 General	

## **Section 5 Container Lashing Equipment (LASHING)**

<b>1</b>	<b>General</b>	<b>297</b>
	1.1 Application	
	1.2 Requirements	
	1.3 Documents and information	

## **Section 6 Dynamic Positioning (DYNAPOS)**

<b>1</b>	<b>General</b>	<b>298</b>
	1.1 Application	
	1.2 Definitions	
	1.3 Dynamic positioning sub-systems	
	1.4 Additional and optional class notation	
	1.5 Installation survey during construction	
	1.6 List of documents to be submitted	
<b>2</b>	<b>Performance analysis</b>	<b>300</b>
	2.1 General	
	2.2 Condition of analysis	
	2.3 Modelling and simulations	
	2.4 Failure mode and effects analysis	
<b>3</b>	<b>Equipment class</b>	<b>303</b>
	3.1 General	
	3.2 Equipment class according to single failure	
<b>4</b>	<b>Functional requirements</b>	<b>303</b>
	4.1 General	
	4.2 Power system	
	4.3 Monitoring of the electricity production and propulsion	
	4.4 Thruster system	
	4.5 Thruster control	

4.6	Thruster monitoring and protection	
4.7	DP Control system	
4.8	Computers	
4.9	Independent joystick system	
<b>5</b>	<b>Position reference system</b>	<b>307</b>
5.1	General	
5.2	Arrangement and performance of reference systems	
5.3	Type of position reference system	
5.4	Other reference systems	
5.5	Vessel sensors	
5.6	Internal Communications	
<b>6</b>	<b>Installation requirements</b>	<b>311</b>
6.1	Cables and piping systems	
6.2	Thruster location	
<b>7</b>	<b>Operational requirements</b>	<b>311</b>
7.1	General	
<b>8</b>	<b>Tests and trials</b>	<b>312</b>
8.1	Inspection at works	
8.2	Trials	
<b>9</b>	<b>Environmental station keeping index ESKI</b>	<b>312</b>
9.1	Definition	
9.2	Environmental conditions	
9.3	Condition of ESKI estimation	
9.4	Documentation to be submitted and example	
<b>10</b>	<b>Enhanced DP system</b>	<b>313</b>
10.1	General	
10.2	DP Control system	
10.3	Position reference system	
10.4	Other vessel sensors	
<b>11</b>	<b>Digital DP survey</b>	<b>314</b>
11.1	General	
11.2	Definitions	
11.3	Documentation and test attendance	
11.4	Recorded parameters	
11.5	Data Communication and Management	
11.6	Hardware requirements	
11.7	Cyber security	
11.8	Validation	
11.9	Verification	
11.10	Qualification	

## **Section 7 Vapour Control System (VCS)**

<b>1</b>	<b>General</b>	<b>322</b>
1.1	Application	
1.2	Definitions	
1.3	Documentation to be submitted	



<b>2</b>	<b>Vapour system</b>	<b>322</b>
	2.1 General	
	2.2 Vapour manifold	
	2.3 Vapour hoses	
	2.4 Vapour overpressure and vacuum protection	
<b>3</b>	<b>Instrumentation</b>	<b>325</b>
	3.1 Cargo tank gauging equipment	
	3.2 Cargo tank high level alarms	
	3.3 Cargo tank overfill alarms	
	3.4 High and low vapour pressure alarms	
<b>4</b>	<b>Instruction manual</b>	<b>325</b>
	4.1 General	
	4.2 Content	
<b>5</b>	<b>Testing and trials</b>	<b>326</b>
	5.1	
	5.2 Shipboard trials	
<b>6</b>	<b>Additional requirements for notation “TRANSFER”</b>	<b>326</b>
	6.1 Application	
	6.2 Equipment	

## **Section 8 Cofferdam Ventilation (COVENT)**

<b>1</b>	<b>General</b>	<b>327</b>
	1.1 Application	
	1.2 Documents to be submitted	
<b>2</b>	<b>Design and construction</b>	<b>327</b>
	2.1 Arrangement	
	2.2 Other technical requirements	
<b>3</b>	<b>Inspection and testing</b>	<b>328</b>
	3.1 Equipment and systems	
	3.2 Testing on board	

## **Section 9 Centralised Cargo and Ballast Water Handling Installations (CARGOCONTROL)**

<b>1</b>	<b>General</b>	<b>329</b>
	1.1 Application	
	1.2 Documents to be submitted	
<b>2</b>	<b>Design and construction requirements</b>	<b>329</b>
	2.1 Control station	
	2.2 Remote control, indication and alarm systems	
<b>3</b>	<b>Inspection and testing</b>	<b>330</b>
	3.1 Equipment and systems	
	3.2 Testing on board	

## Section 10 Ship Manoeuvrability (MANOVR)

<b>1</b>	<b>General</b>	<b>331</b>
	1.1 Application	
	1.2 Manoeuvre evaluation	
<b>2</b>	<b>Definitions</b>	<b>331</b>
	2.1 Geometry of the ship	
	2.2 Standard manoeuvres and associated terminology	
<b>3</b>	<b>Requirements</b>	<b>332</b>
	3.1 Foreword	
	3.2 Conditions in which the requirements apply	
	3.3 Criteria for manoeuvrability evaluation	
<b>4</b>	<b>Additional considerations</b>	<b>332</b>
	4.1 Trials in different conditions	
	4.2 Dynamic instability	

## Section 11 Cold Weather Conditions

<b>1</b>	<b>General</b>	<b>333</b>
	1.1 Application	
	1.2 Documentation to be submitted	
	1.3 Testing	
<b>2</b>	<b>Machinery installations</b>	<b>334</b>
	2.1 General	
	2.2 Principles	
	2.3 Design requirements	
<b>3</b>	<b>Electrical installations</b>	<b>335</b>
	3.1 General	
	3.2 System design	
	3.3 Protection	
<b>4</b>	<b>Additional requirements</b>	<b>335</b>
	4.1 De-icing of deck areas	
	4.2 De-icing tools	
	4.3 Protection of deck machinery	
	4.4 Closing appliances and doors	
	4.5 HVAC	
	4.6 Other protections	
<b>5</b>	<b>Specific requirements for COLD (H tDH, E tDE)</b>	<b>336</b>
	5.1 Hull	
	5.2 Stability	
<b>6</b>	<b>Additional requirements for machinery installations for COLD (H tDH, E tDE)</b>	<b>337</b>
	6.1 General	
	6.2 Principles	
	6.3 Design requirements	

<b>7</b>	<b>Other additional requirements for COLD (H tDH, E tDE)</b>	<b>338</b>
	7.1 General	
	7.2 Cableways supports	
	7.3 Navigation and communication equipment	
	7.4 Fire safety systems	
	7.5 Others protections	
<b>8</b>	<b>Additional requirements for COLD CARGO</b>	<b>338</b>
	8.1 General	
	8.2 Arrangements	
	8.3 Design and arrangement of the cargo heating means	
	8.4 Risk analysis	
	8.5 Materials	

## **Section 12 Efficient Washing of Cargo Tanks (EWCT)**

<b>1</b>	<b>General</b>	<b>340</b>
	1.1 Application	
	1.2 Documents to be submitted	
<b>2</b>	<b>Design requirements</b>	<b>340</b>
	2.1 Cargo tanks	
	2.2 Cargo piping system	
	2.3 Cargo tank cleaning system	

## **Section 13 Protected FO Tanks (PROTECTED FO TANKS)**

<b>1</b>	<b>General</b>	<b>341</b>
	1.1 Application	
	1.2 Definitions	
<b>2</b>	<b>Design requirements</b>	<b>341</b>
	2.1 Distance from the bottom shell plating	
	2.2 Distance from the side shell plating	
	2.3 Oil fuel piping lines	
	2.4 Suction wells	

## **Section 14 Increased Admissible Cargo Tank Pressure (IATP)**

<b>1</b>	<b>Application</b>	<b>343</b>
	1.1 Ships covered by this section	
	1.2 Scope	
<b>2</b>	<b>Documentation to be submitted</b>	<b>343</b>
	2.1 Drawings and documents to be submitted to the Society	
<b>3</b>	<b>Definitions</b>	<b>343</b>
	3.1	
<b>4</b>	<b>General design requirements</b>	<b>343</b>
	4.1 Ship design	
	4.2 Cargo tanks pressure relieving system	
	4.3 Boil-off gas management system	

<b>5</b>	<b>Control, monitoring and safety systems</b>	<b>344</b>
	5.1 Cargo tanks pressure alarms	
	5.2 Indication of the cargo tanks pressure setting	
<b>6</b>	<b>Other</b>	<b>345</b>
	6.1 Shop and gas trials	
	6.2 Ship to ship transfer	

## **Section 15 Enhanced Fire Protection (EFP-AMC)**

<b>1</b>	<b>General</b>	<b>346</b>
	1.1 Application	
<b>2</b>	<b>Protection of accommodation spaces (EFP-A)</b>	<b>346</b>
	2.1 Application	
	2.2 Prevention of fire	
	2.3 Detection and alarm	
	2.4 Containment of fire	
	2.5 Escape	
<b>3</b>	<b>Protection of machinery spaces (EFP-M)</b>	<b>347</b>
	3.1 Application	
	3.2 Machinery spaces general arrangement	
	3.3 Detection and alarm	
	3.4 Ventilation system	
	3.5 Fixed water-based local application fire-fighting system	
	3.6 Escape	
	3.7 Central control station	
<b>4</b>	<b>Protection of cargo decks and cargo spaces (EFP-C)</b>	<b>347</b>
	4.1 Cargo ships	
	4.2 Ro-ro cargo ships and pure car and truck carriers	
	4.3 Oil tankers, FLS tankers and chemical tankers	
	4.4 Liquefied gas carriers	
<b>5</b>	<b>Onboard testing</b>	<b>349</b>
	5.1 Hot spot verification	

## **Section 16 SINGLEPASSLOADING**

<b>1</b>	<b>General</b>	<b>350</b>
	1.1 Application	
	1.2 Definitions	
<b>2</b>	<b>Documentation to be submitted</b>	<b>350</b>
	2.1 Design loading rate	
	2.2 Loading sequences	
	2.3 Hold mass curves	
<b>3</b>	<b>Loading instrument and alternative loading</b>	<b>351</b>
	3.1 Loading instrument	
	3.2 Alternative loading	

<b>4</b>	<b>Hull requirements</b>	<b>351</b>
	4.1 General	
	4.2 Hull structure	
	4.3 Control and monitoring	
<b>5</b>	<b>System requirements</b>	<b>351</b>
	5.1 General	
	5.2 Ballast piping	
	5.3 Control and monitoring	

## **Section 17 Bow and Stern Loading / Unloading Systems**

<b>1</b>	<b>General</b>	<b>352</b>
	1.1 Application	
	1.2 Class notations	
	1.3 Scope of classification	
	1.4 Definitions	
	1.5 Documents to be submitted	
	1.6 Operating Manual	
<b>2</b>	<b>Materials</b>	<b>353</b>
	2.1 General	
<b>3</b>	<b>General design</b>	<b>353</b>
	3.1 Mooring system	
	3.2 Cargo piping system	
	3.3 Ventilation	
	3.4 Hazardous areas and electrical installations	
	3.5 Positioning	
	3.6 Emergency Disconnection System (EDS)	
	3.7 Control station	
	3.8 Communications	
	3.9 Safety features	

## **Section 18 Supply at Sea (SAS)**

<b>1</b>	<b>General</b>	<b>355</b>
	1.1 Application	
	1.2 Documents to be submitted	
	1.3 Definitions	
<b>2</b>	<b>Design and construction</b>	<b>356</b>
	2.1 SAS equipment	
	2.2 Steering capability	
<b>3</b>	<b>Arrangement and installation</b>	<b>357</b>
	3.1 General	
	3.2 Arrangement of SAS stations	
	3.3 SAS control station arrangement	
	3.4 Communication	
	3.5 Fluid transfer	
	3.6 Solid transfer	
	3.7 Electrical installation	

<b>4</b>	<b>Certification, inspection and testing</b>	<b>359</b>
4.1	Type approval procedure	
4.2	Inspection at works of the SAS equipment	
4.3	Prototype tests	
4.4	Tests on board	

## **Section 19 Permanent Means of Access (ACCESS)**

<b>1</b>	<b>General</b>	<b>361</b>
1.1	Application	
1.2	Definitions	

## **Section 20 Helideck (HEL)**

<b>1</b>	<b>General</b>	<b>362</b>
1.1	Application	
1.2	Reference standard	

## **Section 21 Battery System**

<b>1</b>	<b>General</b>	<b>363</b>
1.1	Application	
1.2	Documents to be submitted	
<b>2</b>	<b>Definitions and acronyms</b>	<b>363</b>
2.1	System considered	
2.2	Definitions	
<b>3</b>	<b>Safety and design issues</b>	<b>364</b>
3.1	Battery compartment	
3.2	Battery pack	
<b>4</b>	<b>Availability of power</b>	<b>366</b>
4.1	Ship configuration	
4.2	Case 1: global battery system failure leads to loss of propulsion or of main electrical sources	
4.3	Case 2: global battery system failure does not lead to any loss regarding ship propulsion and main source of power	
<b>5</b>	<b>Test and certification process for batteries</b>	<b>366</b>
5.1	Battery cells	
5.2	Equipment used in battery systems	
5.3	Battery packs and associated BMS	
5.4	Onboard tests of battery compartment and fire-extinguishing system	

## **Section 22 Electric Hybrid**

<b>1</b>	<b>General</b>	<b>369</b>
1.1	Application	
1.2	Documents to be submitted	
1.3	Definitions	

<b>2</b>	<b>System design</b>	<b>371</b>
2.1	Quality of power supply	
2.2	Power distribution	
<b>3</b>	<b>Electric Energy Storage System (ESS)</b>	<b>372</b>
3.1	ESS battery pack	
3.2	ESS semiconductor converter	
3.3	ESS transformer	
3.4	Energy Control System (ECS)	
3.5	ESS capacity	
3.6	ESS charging	
3.7	ESS control and instrumentation	
<b>4</b>	<b>Installation on board</b>	<b>373</b>
4.1	Safety and design of battery system	
<b>5</b>	<b>Testing</b>	<b>373</b>
5.1	Factory acceptance tests	
5.2	Onboard tests	
5.3	Tests of battery compartment and fire-extinguishing system	

## **Section 23 Unsheltered Anchoring**

<b>1</b>	<b>General</b>	<b>375</b>
1.1	Application	
<b>2</b>	<b>Anchoring equipment</b>	<b>375</b>
2.1	Equipment number for deep and unsheltered water	
2.2	Anchors	
2.3	Chain cables for bower anchors	
2.4	Anchor windlass and chain stopper	

## **Section 24 SCRUBBER READY**

<b>1</b>	<b>General</b>	<b>377</b>
1.1	Scope of this notation	
<b>2</b>	<b>Documentation to be submitted</b>	<b>377</b>
2.1	Status of the documentation	
2.2	List of documents	
<b>3</b>	<b>Requirements for the additional class notation SCRUBBER-READY</b>	<b>377</b>
3.1	General arrangement	
3.2	Hull items	
3.3	Machinery items	
3.4	Electricity items	
3.5	Safety items	
3.6	Stability items	

## Section 25 Gas-prepared Ships

<b>1</b>	<b>General</b>	<b>381</b>
1.1	Application	
1.2	Documents and information to be submitted	
1.3	Definitions	
<b>2</b>	<b>Requirements for the additional class notation GAS-PREPARED</b>	<b>381</b>
2.1	General arrangement	
2.2	Hull and Stability	
2.3	Machinery	
<b>3</b>	<b>Additional requirements for notations S, P, ME-DF, AE and B</b>	<b>383</b>
3.1	Notation S	
3.2	Notation P	
3.3	Notation ME-DF	
3.4	Notation AE	
3.5	Notation B	

## Section 26 Ultra-Low Emission Vessel (ULEV)

<b>1</b>	<b>General</b>	<b>384</b>
1.1	Scope	
1.2	Application	
1.3	Documents to be submitted	
<b>2</b>	<b>Definitions</b>	<b>385</b>
2.1		
<b>3</b>	<b>Requirements for ULEV additional class notation</b>	<b>385</b>
3.1	Requirements for the engines	
3.2	Emission levels	
3.3	Emission control monitoring	
3.4	ULEV Mode	
<b>4</b>	<b>Emission measurements</b>	<b>387</b>
4.1	Pollutants to be measured	
4.2	Measurements	
4.3	Fuel specification	
4.4	Deterioration factors	
4.5	Control areas	
<b>5</b>	<b>Onboard surveys</b>	<b>389</b>
5.1	Initial survey	

## Section 27 Man Overboard Detection (MOB)

<b>1</b>	<b>Application</b>	<b>390</b>
1.1	General	
1.2	Reference to other regulations and standard	
1.3	Definitions	
1.4	Documents to be submitted	



<b>2</b>	<b>General design requirements</b>	<b>391</b>
	2.1 System description	
	2.2 MOB detection zone	
	2.3 MOB alert and alarm	
	2.4 Data storage	
	2.5 Control system	
	2.6 Events markers	
	2.7 Voyage Data Recorder	
<b>3</b>	<b>Survey onboard</b>	<b>392</b>
	3.1 General	
	3.2 MOB testing manikin	
	3.3 Environmental conditions	
	3.4 Probability of detection	
	3.5 Testing	
	3.6 False alerts	

## **Section 28 Heading Control in Adverse Conditions**

<b>1</b>	<b>General</b>	<b>394</b>
	1.1 Application	
	1.2 Definitions	
	1.3 Documents to be submitted	
<b>2</b>	<b>Heading control analysis</b>	<b>396</b>
	2.1 General	
	2.2 Environmental adverse conditions	
	2.3 Loading conditions	
	2.4 Performance criteria	
<b>3</b>	<b>Requirements for duplicated propulsion and steering systems</b>	<b>396</b>
	3.1 Principles	
	3.2 Failure and casualty scenarios	
	3.3 Propulsion and steering systems	
	3.4 Propulsion auxiliary systems	
	3.5 Steering systems	
	3.6 Electrical installations	
	3.7 Automation	
<b>4</b>	<b>Requirements for independent propulsion and steering systems</b>	<b>398</b>
	4.1 General design requirements	
	4.2 Propulsion and steering systems	
	4.3 Electrical installations	
	4.4 Automation	
	4.5 Compartment arrangement	
	4.6 Propulsion auxiliary systems	
	4.7 Ventilation system	
<b>5</b>	<b>Tests on board</b>	<b>399</b>
	5.1 Operating tests	
	5.2 Sea trials	

## Section 29 Electric Hybrid Prepared

<b>1</b>	<b>General</b>	<b>400</b>
	1.1 Application	
	1.2 Definitions and abbreviations	
	1.3 Documents to be submitted	
	1.4 Conversion to electric hybrid	
<b>2</b>	<b>System design</b>	<b>402</b>
	2.1 Ship design	
	2.2 Cables	
<b>3</b>	<b>Electric energy storage system (ESS)</b>	<b>402</b>
	3.1 ESS Batteries	
	3.2 ESS semiconductor converter and transformer	
	3.3 ESS Control and instrumentation	
<b>4</b>	<b>Installation on board</b>	<b>402</b>
	4.1 Spaces	
<b>5</b>	<b>Testing</b>	<b>403</b>
	5.1 Factory acceptance tests	
	5.2 On-board tests	

## Section 30 Enhanced Cargo Fire Protection for Container Ships (ECFP)

<b>1</b>	<b>General</b>	<b>404</b>
	1.1 Application	
	1.2 Innovative technologies	
	1.3 Documents to be submitted	
<b>2</b>	<b>Ships granted with the notation ECFP-1</b>	<b>405</b>
	2.1 General	
	2.2 Portable equipment	
	2.3 Compressed air system for breathing apparatuses	
<b>3</b>	<b>Additional requirements for ships granted with the notation ECFP-2</b>	<b>406</b>
	3.1 General	
	3.2 Central control station	
	3.3 Fire detection	
	3.4 Water supply systems	
	3.5 Fixed water monitors covering the on-deck cargo stowage area	
	3.6 Water-spray system below hatch cover	
	3.7 Flooding system for the cargo holds	
	3.8 Water-spray system for the protection of the superstructure block	
	3.9 Design of the ventilation system	
<b>4</b>	<b>Additional requirements for ships granted with the notation ECFP-3</b>	<b>411</b>
	4.1 General	
	4.2 Portable equipment	
	4.3 Fire detection	
<b>5</b>	<b>Certification and testing</b>	<b>412</b>
	5.1 Type approval of portable fire-fighting devices for stacked containers	
	5.2 Onboard tests	

## **Section 31 Biological Risk Management (BIORISK)**

<b>1</b>	<b>General</b>	<b>414</b>
	1.1 Application	
	1.2 Documents to be submitted	
<b>2</b>	<b>BIORISK MANAGED</b>	<b>414</b>
	2.1 Biological risk assessment	
	2.2 Outbreak Management Plan	
	2.3 Personnel Protective Equipment (PPE)	
	2.4 Signs and marking	
<b>3</b>	<b>Additional requirements for BIORISK SECURED</b>	<b>415</b>
	3.1 General	
	3.2 Quarantine area	
	3.3 Ventilation of accommodation spaces and normally manned control stations	
	3.4 Other equipment	
<b>4</b>	<b>On board testing</b>	<b>417</b>
	4.1 Initial survey	

## **Section 32 Hybrid Mechanical Propulsion**

<b>1</b>	<b>General</b>	<b>418</b>
	1.1 Application	
	1.2 Definitions	
	1.3 Documents to be submitted	
<b>2</b>	<b>System design</b>	<b>418</b>
	2.1 Propulsion systems	
	2.2 Electric Production systems	
	2.3 Diesel propulsion systems	
	2.4 Electrical propulsion systems	
	2.5 Combined diesel and electric propulsion systems	
<b>3</b>	<b>Control of propulsion machinery</b>	<b>420</b>
	3.1 Remote control from navigating bridge of the propulsion machinery	
	3.2 Local control of the propulsion machinery	
	3.3 Switch over from one propulsion type mode to another one	
	3.4 Displays and alarms	
<b>4</b>	<b>Testing</b>	<b>421</b>
	4.1 Onboard tests	

## **Section 33 OPEN-HATCH**

<b>1</b>	<b>General</b>	<b>422</b>
	1.1 Application	
	1.2 Definitions	
<b>2</b>	<b>Freeboard</b>	<b>422</b>
	2.1 General	

<b>3</b>	<b>Stability</b>	<b>422</b>
	3.1 Intact stability without water ingress	
	3.2 Intact stability considering water ingress	
	3.3 Damage Stability	
<b>4</b>	<b>Hull</b>	<b>423</b>
	4.1 Hull girder strength	
	4.2 Hull scantlings	
<b>5</b>	<b>Procedure of model tests</b>	<b>423</b>
	5.1 General	
<b>6</b>	<b>Ship arrangement</b>	<b>424</b>
	6.1 Hold bilge dewatering system and freeing ports	
<b>7</b>	<b>Fire protection</b>	<b>425</b>
	7.1 Fire insulation	
	7.2 Water-spray system	
	7.3 Dangerous goods	
<b>8</b>	<b>Testing</b>	<b>425</b>
	8.1 Onboard tests	

## **Section 34 FSRU-READY**

<b>1</b>	<b>General</b>	<b>426</b>
	1.1 Application	
	1.2 Definition	
	1.3 Plans and documents to be submitted	
	1.4 Conversion to FSRU	
<b>2</b>	<b>Requirements for the additional class notation FSRU-READY</b>	<b>426</b>
	2.1 Assumption for site condition	
	2.2 General arrangement	
	2.3 Hull and stability	
	2.4 Design loads	
	2.5 Structural strength	
	2.6 Sloshing on-site	
<b>3</b>	<b>Additional requirements for notations P, R and I</b>	<b>428</b>
	3.1 Notation P	
	3.2 Notation R	
	3.3 Notation I	

## **Section 35 Ammonia-Prepared Ships**

<b>1</b>	<b>General</b>	<b>429</b>
	1.1 Application	
	1.2 Documents and information to be submitted	
	1.3 Definitions	
	1.4 Ammonia main characteristics and consequences on the design of the ship installations	

<b>2</b>	<b>General requirements for the additional class notation AMMONIA-PREPARED</b>	<b>432</b>
	2.1 Design principles	
	2.2 General arrangement	
	2.3 Ship structure and stability	
	2.4 Machinery	
<b>3</b>	<b>Additional requirements for notation S</b>	<b>433</b>
	3.1 General	
<b>4</b>	<b>Additional requirements for notation T</b>	<b>433</b>
	4.1 General	
	4.2 Design of the ammonia storage tank	
<b>5</b>	<b>Additional requirements for notation H</b>	<b>433</b>
	5.1 General	
	5.2 Design of the ammonia fuel handling system	
<b>6</b>	<b>Additional requirements for notation P</b>	<b>433</b>
	6.1 General	
	6.2 Design of the ammonia piping system	
<b>7</b>	<b>Additional requirements for notation B</b>	<b>434</b>
	7.1 General	
	7.2 Design of the ammonia combustion unit (thermal oxidizer)	
	7.3 Design of the refrigerating system	

## **Section 36 Sustainable Ships**

<b>1</b>	<b>General</b>	<b>435</b>
	1.1 Scope	
	1.2 Notation SUSTAINABLESHIP-1	
	1.3 Notation SUSTAINABLESHIP-2	
	1.4 Surveys	



Part F  
**Additional Class Notations**

Chapter 1

**VERISTAR SYSTEM (STAR)**

---

<b>SECTION 1</b>	<b>VERISTAR-HULL, VERISTAR-HULL CM AND VERISTAR-HULL SIS</b>
<b>SECTION 2</b>	<b>STAR-HULL</b>
<b>SECTION 3</b>	<b>STAR-MACH, STAR-MACH SIS</b>
<b>SECTION 4</b>	<b>STAR-REGAS</b>
<b>SECTION 5</b>	<b>STAR-CARGO</b>
<b>APPENDIX 1</b>	<b>ACCEPTANCE CRITERIA FOR ISOLATED AREAS OF ITEMS</b>
<b>APPENDIX 2</b>	<b>ACCEPTANCE CRITERIA FOR ISOLATED ITEMS</b>
<b>APPENDIX 3</b>	<b>ACCEPTANCE CRITERIA FOR ZONES</b>
<b>APPENDIX 4</b>	<b>OWNER'S HULL INSPECTION REPORTS</b>





## SECTION 1

# VERISTAR-HULL, VERISTAR-HULL CM AND VERISTAR-HULL SIS

## 1 General

### 1.1 Application

**1.1.1** The additional class notation **VeriSTAR-HULL**, **VeriSTAR-HULL CM** and **VeriSTAR-HULL SIS** are assigned at the design stage or after construction. The notation **VeriSTAR-HULL SIS** is to be maintained during the service life. These notations are granted to ships complying with the requirements of this Section, in accordance with Pt A, Ch 1, Sec 2, [6.2].

### 1.2 Scope

**1.2.1** The additional class notation **VeriSTAR-HULL** is assigned to a ship in order to reflect the following:

- a structural tridimensional analysis has been performed for the hull structures, as defined in Pt B, Ch 7, App 1 or Pt B, Ch 7, App 2 or Pt B, Ch 7, App 3 or in the Common Structural Rules (NR606), as applicable.

**1.2.2** The additional class notation **VeriSTAR-HULL CM** is assigned to a ship in order to reflect the following:

- the ship fulfils requirements of additional class notation **VeriSTAR-HULL**
- a hot spot map has been made available for construction surveys and is kept on board the ship after delivery.

**1.2.3** The additional class notation **VeriSTAR-HULL SIS** is assigned to a ship in order to reflect the following:

- the ship fulfils requirements of additional class notation **VeriSTAR-HULL CM**
- the hull structure condition is periodically assessed, usually at the class renewal survey, using the results of the inspections and thickness measurements performed during the survey. The results of this assessment is made available to the Owner.

## 2 Assignment of the notation

### 2.1 VeriSTAR-Hull

**2.1.1** The procedure for the assignment of a **VeriSTAR-HULL** notation to a ship is as follows:

- a) The Interested Party submits to the Society the following documents:
  - Plans and documents necessary to carry out the structural analysis, listed in Pt B, Ch 1, Sec 3 or in the Common Structural Rules (NR606)

- Results of the analysis of the longitudinal strength and local scantlings of the plating and secondary stiffeners located in the cargo area in compliance with the requirements of Part B, Chapter 6 and Pt B, Ch 7, Sec 1 and Pt B, Ch 7, Sec 2, respectively, or of the Common Structural Rules (NR606)
  - Results of the tridimensional analysis of the hull structure described in Pt B, Ch 7, Sec 3or in the Common Structural Rules (NR606)
  - Results of the fatigue analysis of the hull structure described in Pt B, Ch 7, Sec 4 or in the Common Structural Rules (NR606), as applicable.
- b) the Interested Party reports to the Society the changes in structural scantlings or design made during the design and building phase. In particular, an as-built version of the drawings is to be submitted to the Society for further reference
  - c) the Society reviews the structural analyses and contents of the ship structural database and, if satisfied with the results, grants the **VeriSTAR-HULL** notation.

### 2.2 VeriSTAR-HULL CM

#### 2.2.1 General

The procedure for the assignment of the **VeriSTAR-HULL CM** notation to a ship is as follows:

- a) The procedure described in [2.1.1] should be followed
- b) The Interested Party submits to the Society a hot spot map as described in [2.2.2]
- c) The Society reviews the hot spot map and, if satisfied with the results, grants the **VeriSTAR-HULL CM** notation.

#### 2.2.2 Hot spot map

The items to be included in the hot spot map are, in general, the following:

- items (such as plating panels or primary supporting members) for which the FEM analysis carried out at design stage show that the ratio between applied loads and allowable limits exceed 0,975
- items identified as "hot spot item" during structural reassessment, taking into account actual conditions revealed by updated thickness gaugings
- structural details subjected to fatigue, based on the list defined in Pt B, Ch 11, App 2 or NR606, Chapter 9. As a rule, only fatigue details with a calculated damage ratio above 0,8 are to be included in the hot spot map
- other items, depending on the results of the structural analyses and/or on experience.

At early design stage, a preliminary hot spot map with a list of hot spots based only on experience may be provided to the Society to achieve the first construction surveys. This preliminary document is to be updated according to the calculation results obtained from FEM analysis and fatigue analysis as soon as they are available.

The layout of the hot spot map is to be as convenient as possible for inspection/survey purpose.

## 2.3 VeriSTAR-Hull SIS

**2.3.1** The procedure for the assignment of a **VeriSTAR-HULL SIS** notation to an existing ship is as follows:

- a) the Interested Party supplies the documents listed in Tab 1. In addition, depending of the service and specific features of the ship, the Society may request plans and documents in addition to those listed in Tab 1
- b) the Society may request additional measurements or inspections in order to update the latest available thickness gaugings and condition reports in order to obtain a reliable picture of the ship structure in its actual condition
- c) the Interested Party supplies the results of the structural analyses described in [2.1.1] for the ship in the as-built condition and, if deemed necessary, with the actual conditions revealed by the updated thickness gaugings and inspections
- d) the Interested Party supplies the hot spot map of the structure taking into account actual conditions if relevant
- e) the Society reviews the results of these analyses and the content of the structural model of the ship and, if satisfied, grants the **VeriSTAR-HULL SIS** notation.

## 2.4 Acceptance criteria for thickness measurements

**2.4.1** When the **VeriSTAR-HULL SIS** notation is granted to a unit as described in [2.3] the acceptance criteria for measured thicknesses are given in Pt A, Ch 2, App 3 or Ch 1, App 2 for items as deemed appropriate by the Society (for example a plating panel or an ordinary stiffener).

When the acceptance criteria are not fulfilled, actions according to [2.4.2] are to be taken.

**2.4.2** For each item, thicknesses are measured at several points and the average value of these thicknesses is to satisfy the acceptance criteria for the relevant item.

If the criteria of measured thicknesses are not fulfilled for an item, then this item is to be repaired or replaced.

**Table 1 : Existing ships - Plans and documents to be submitted to perform the structural analysis**

Plans and documents
Midship section
Transverse sections
Shell expansion
Longitudinal sections and decks
Double bottom
Pillar arrangements
Framing plan
Deep tank and ballast tank bulkheads
Watertight subdivision bulkheads
Watertight tunnels
Wash bulkheads
Fore part structure
Aft part structure
Last thickness measurement report
Loading manual

## SECTION 2

## STAR-HULL

### 1 General

#### 1.1 Principles

##### 1.1.1 Application

The additional class notation **STAR-HULL** is assigned, in accordance with Pt A, Ch 1, Sec 2, [6.2.4], to ships complying with the requirements of this Section.

##### 1.1.2 Scope

The additional class notation **STAR-HULL** is assigned to a ship in order to reflect the fact that a procedure including periodical and corrective maintenance, as well as periodical and occasional inspections of hull structures and equipment, (hereafter referred to as the Inspection and Maintenance Plan) are dealt with on board by the crew and at the Owner's offices according to approved procedures.

The assignment of the notation implies that requirements for assignment of **VeriSTAR-HULL SIS** notation have been fulfilled in accordance with Ch 1, Sec 1

The implementation of the Inspection and Maintenance Plan is surveyed by the Society through:

- periodical check of the hull structure, normally at the class renewal survey, against defined acceptance criteria and based on:
  - the collected data from actual implementation of the Inspection and Maintenance Plan
  - the results of the inspections, thickness measurements and other checks carried out during the class renewal survey (see Pt A, Ch 5, Sec 2, [3]).

##### 1.1.3 Safety management system

The Inspection and Maintenance Plan required under the scope of the **STAR-HULL** notation may form part of the Safety Management System to be certified in compliance with the ISM Code.

#### 1.2 Conditions for the assignment of the notation

##### 1.2.1 Assignment of the notation

The procedure for the assignment of the **STAR-HULL** notation is the following:

- a request for the notation is to be sent to the Society:
  - signed by the party applying for the classification, in the case of new ships
  - signed by the Owner, in the case of existing ships

- the following documents are to be submitted to the Society by the Interested Party:
  - plans and documents necessary to carry out the structural analysis, and information on coatings and on cathodic protection (see [2.1])
  - the hot spot map of the structure (see Ch 1, Sec 1, [2.2.2])
  - the Inspection and Maintenance Plan to be implemented by the Owner (see [2.2])
- the Society reviews the Inspection and Maintenance Plan, taking into account the results of the structural analysis, as well as the information concerning the ship database.

### 2 Documentation to be submitted

#### 2.1 Plans and documents to be submitted

##### 2.1.1 Structural analysis

The plans and documents necessary to support and/or perform the structural analysis covering hull structures are:

- those submitted for class as listed in Pt B, Ch 1, Sec 3, for new ships
- those listed in Tab 1, for existing ships. However, depending on the service and specific features of the ship, the Society reserves the right to request additional or different plans and documents from those in Tab 1.

**Table 1 : Existing ships - Plans and documents to be submitted to perform the structural analysis**

Plans and documents
Midship section
Transverse sections
Shell expansion
Longitudinal sections and decks
Double bottom
Pillar arrangements
Framing plan
Deep tank and ballast tank bulkheads
Watertight subdivision bulkheads
Watertight tunnels
Wash bulkheads
Fore part structure
Aft part structure
Last thickness measurement report
Loading manual

### 2.1.2 Coatings

The following information on coatings is to be submitted:

- list of all structural items which are effectively coated
- characteristics of the coating system.

### 2.1.3 Cathodic protection

The following information on sacrificial anodes is to be submitted:

- localisation of anodes in spaces, on bottom plating and sea chests
- dimensions and weight of anodes in new condition.

## 2.2 Inspection and Maintenance Plan (IMP)

**2.2.1** The Inspection and Maintenance Plan is to be based on the Owner's experience and on the results of the structural analyses including the hot spot map.

The Inspection and Maintenance Plan is to include:

- the list of areas, spaces and hull equipment to be subjected to inspection
- the periodicity of inspections
- the elements to be assessed during the inspection for each area or space, as applicable:
  - coating
  - anodes
  - thicknesses
  - pitting
  - fractures
  - deformations
- the elements to be assessed during the inspection of hull equipment.

**2.2.2** As regards the maintenance plan, the following information is to be given:

- maintenance scope
- maintenance type (inspection, reconditioning)
- maintenance frequency (periodicity value unit is to be clearly specified, i.e. hours, week, month, year)
- place of maintenance (port, sea, etc.)
- manufacturer's maintenance and repair specifications, as applicable
- procedures contemplated for repairs or renewal of structure or equipment.

## 3 Inspection and Maintenance Plan (IMP)

### 3.1 Minimum requirements

**3.1.1** The minimum requirements on the scope of the Inspection and Maintenance Plan (IMP), the periodicity of inspections, the extent of inspection and maintenance to be scheduled for each area, space or equipment concerned, and the minimum content of the report to be submitted to the Society after the inspection are given hereafter.

**3.1.2** At the Owner's request, the scope and periodicity may be other than those specified below, provided that this is agreed with the Society.

**3.1.3** The IMP performed at periodical intervals does not prevent the Owner from carrying out occasional inspections and maintenance as a result of an unexpected failure or event (such as damage resulting from heavy weather or cargo loading/unloading operation) which may affect the hull or hull equipment condition.

Interested parties are also reminded that any damage to the ship which may affect the class is to be reported to the Society.

### 3.2 General scope of IMP

**3.2.1** The IMP is to cover at least the following areas/items:

- deck area structure
- hatch covers and access hatches
- deck fittings
- steering gear
- superstructures
- shell plating
- ballast tanks, including peaks,
- cargo holds, cargo tanks and spaces
- other accessible spaces
- rudders
- sea connections and overboard discharges
- sea chests
- propellers.

### 3.3 Periodicity of inspections

**3.3.1** Inspections are to be carried out at least with the following periodicity:

- Type 1: two inspections every year, with the following principles:
  - one inspection is to be carried out outside the window provided for the execution of the annual class survey, in the vicinity of the halfway date of the anniversary date interval
  - the other inspection is to be carried out preferably not more than two months before the annual class survey is conducted
  - the minimum interval between any two consecutive inspections of the same item is to be not less than four months.
- Type 2: inspection at annual intervals, preferably not more than four months before the annual class survey is carried out.
- Type 3: inspection at bottom surveys.

**3.3.2** The following areas/items are to be inspected with a periodicity of Type 1:

- deck area structure
- shell plating above waterline
- hatch covers and access hatches
- deck equipment
- superstructures

- ballast tanks, including peaks
- cargo holds and spaces
- other accessible spaces
- sea connections and overboard discharges.

For ships less than 5 years old, 25% in number of ballast tanks (with a minimum of 1) are to be inspected annually, in rotation, so that all ballast tanks are inspected at least once during the 5-year class period.

For ships 5 years old or more, all ballast tanks are to be inspected annually.

**3.3.3** The following areas are to be inspected with a periodicity of Type 2:

- bunker and double bottom fuel oil tanks
- fresh water tanks
- cargo tanks.

**3.3.4** Whenever the outside of the ship's bottom is examined in drydock or on a slipway, inspections are to be carried out on the following items:

- rudders
- propellers
- bottom plating
- sea chests and anodes.

In addition, the requirement under Pt A, Ch 2, Sec 2, [5.4.2] is to be complied with.

## 3.4 Extent of inspections

### 3.4.1 Deck area structure

The deck plating, structure over deck and hatch coamings, as applicable are to be visually examined for assessment of the coating, and detection of fractures, deformations and corrosion.

When structural defects affecting the class (such as fractures or deformations) are found, the Society is to be called for occasional survey attendance. If such structural defects are repetitive in similar areas of the deck, a program of additional close-up surveys may be planned at the Society's discretion for the next inspections.

In other cases, such as coating found in poor condition, repairs or renewal are to be dealt with, or a program of maintenance is to be set in agreement with the Society, at a suitable time, but at the latest at the next intermediate or class renewal survey, whichever comes first.

### 3.4.2 Hatch covers and small hatches

Cargo hold hatch covers and related accessories are to be visually examined and checked for operation under the same scope as that required for annual class survey in Pt A, Ch 3, Sec 1, [2.3]. The condition of coating is to be assessed.

Access hatches are to be visually examined, in particular tightness devices, locking arrangements and coating condition, as well as signs of corrosion.

Any defective tightness device or securing/locking arrangement is to be dealt with. Operating devices of hatch covers are to be maintained according to the manufacturer's requirements and/or when found defective.

For structural defects or coating found in poor condition, refer to [3.4.1].

### 3.4.3 Deck fittings

The inspection of deck fittings is to cover at least the following items:

- Piping on deck

A visual examination of piping is to be carried out, with particular attention to coating, external corrosion, tightness of pipes and joints (examination under pressure), valves and piping supports. Operation of valves is to be checked.

Any defective tightness, supporting device or valve is to be dealt with.

- Vent system

A visual examination of the vent system is to be carried out. Dismantling is to be carried out as necessary for checking the condition of closure (flaps, balls) and clamping devices and of screens.

Any defective item is to be dealt with.

- Ladders, guard rails, bulwarks, walkways

A visual examination is to be carried out with attention to the coating condition (as applicable), corrosion, deformation or missing elements.

Any defective item is to be dealt with.

- Anchoring and mooring equipment

A visual examination of the windlass, winches, capstans, anchor and visible part of the anchor chain is to be carried out. A working test is to be effected by lowering a sufficient length of chain on each side and the chain lengths thus ranged out are to be examined (shackles, studs, wastage).

Any defective item is to be dealt with. For replacement of chains or anchors, the Society is to be requested for attendance.

The manufacturer's maintenance requirements, if any, are to be complied with.

- Other deck fittings

Other deck fittings are to be visually examined and dealt with under the same principles as those detailed in the items above according to the type of fitting.

### 3.4.4 Steering gear

The inspection of the installation is to cover:

- examination of the installation
- test with main and emergency systems
- changeover test of working rams.

### 3.4.5 Superstructures

The structural part of superstructures is to be visually examined and checked under the same scope as that required for deck structure.

The closing devices (doors, windows, ventilation system, skylights) are to be visually examined with attention to tightness devices and checked for their proper operation.

Any defective item is to be dealt with.

### 3.4.6 Shell plating

The shell plating, sides and bottom, are to be visually examined for assessment of the coating, and detection of fractures, deformations and corrosion.

When structural defects affecting the class (such as fractures or deformations) are found, the Society is to be called for occasional survey attendance. If such structural defects are repetitive in similar areas of the shell plating, a program of additional close-up surveys may be planned at the Society's discretion for the next inspections.

In other cases, such as coating found in poor condition, repairs or renewal are to be dealt with, or a program of maintenance is to be set in agreement with the Society, at a suitable time, but at the latest at the next intermediate or class renewal survey, whichever comes first.

### 3.4.7 Ballast tanks

Ballast tanks, including peaks, are to be overall surveyed with regards to:

- structural condition (fractures, deformations, corrosion)
- condition of coating and anodes, if any
- fittings such as piping, valves.

A program of close-up survey may also be required, depending on the results of the structural analyses and the hot spot map.

When structural defects affecting the class are found, the Society is to be called for occasional survey attendance. If such structural defects (such as fractures or deformations) are repetitive in similar structures in the same ballast tanks or in other ballast tanks, a program of additional close-up survey may be planned at the Society's discretion for the next inspections.

In other cases, such as coating found in poor condition or anodes depleted, repairs or renewal are to be dealt with, or a program of maintenance is to be set in agreement with the Society, at a suitable time, but at the latest at the next intermediate or class renewal survey, whichever comes first.

### 3.4.8 Cargo holds and spaces

Dry cargo holds and other spaces such as container holds, vehicle decks are to be subjected to overall examination and dealt with in the case of defects, under the same scope as that required for ballast tanks. Attention is also to be given to other fittings, such as bilge wells (cleanliness and working test) and ladders.

Cargo tanks are to be overall surveyed with regards to:

- structural condition (fractures, deformations, corrosion)
- condition of coating and anodes, if any
- fittings such as piping, valves.

A program of close-up survey may also be required, depending on the results of the structural analyses and the hot spot map.

When structural defects affecting the class are found, the Society is to be called for occasional survey attendance. If such structural defects (such as fractures or deformations) are repetitive in similar structures in the same cargo tanks or in other cargo tanks, a program of additional close-up survey may be planned at the Society's discretion for the next inspections.

In other cases, such as coating found in poor condition or anodes depleted, repairs or renewal are to be dealt with, or a program of maintenance is to be set in agreement with the Society, at a suitable time, but at the latest at the next intermediate or class renewal survey, whichever comes first.

### 3.4.9 Other accessible spaces

Other spaces accessible during normal operation of the ship or port operations, such as cofferdams, void spaces, pipe tunnels and machinery spaces are to be examined and dealt with under the same scope as that required for dry cargo holds and spaces.

Consideration is also to be given to the cleanliness of spaces where machinery and/or other equivalent equipment exist which may give rise to leakage of oil, fuel water or other leakage (such as main and auxiliary machinery spaces, cargo pump rooms, cargo compressor rooms, dredging machinery spaces, steering gear space).

### 3.4.10 Rudder(s)

A visual examination of rudder blade(s) is to be carried out to detect fractures, deformations and corrosion. Plugs, if any, have to be removed for verification of tightness of the rudder blade(s). Thickness measurements of plating are to be carried out in case of doubt. Access doors to pintles (if any) have to be removed. Condition of pintle(s) has to be verified. Clearances have to be taken.

Condition of connection with rudder stock is to be verified.

Tightening of both pintles and connecting bolts is to be checked.

### 3.4.11 Sea connections and overboard discharges

A visual external examination of sea inlets, outlet corresponding valves and piping is to be carried out in order to check tightness. An operation test of the valves and manoeuvring devices is to be performed.

Any defective tightness and/or operability is to be dealt with.

### 3.4.12 Sea chests

Sea chests have to be examined with regards to:

- structural condition (fractures, deformations, corrosion)
- condition of cleanliness, coating and anodes
- visual examination of accessible part of piping or valve.

### 3.4.13 Propellers

A visual examination of propeller blades, propeller boss and propeller cap is to be carried out as regards fractures, deformations and corrosion. For variable pitch propellers, absence of leakage at the connection between the blades and the hub is to be also ascertained.

Absence of leakage of the aft tailshaft sealing arrangement is to be ascertained.

### 3.4.14 Cargo tanks, bunker and double bottom fuel oil tanks, fresh water tanks

Bunker and double bottom fuel oil tanks are to be overall surveyed with regards to:

- structural condition (fractures, deformations, corrosion)
- condition of coating and anodes, if any
- fittings such as piping, valves.

A program of close-up survey may also be required, depending on the results of the structural analyses and the hot spot map.

When structural defects affecting the class are found, the Society is to be called for occasional survey attendance. If such structural defects (such as fractures or deformations) are repetitive in similar structures in the same bunker/double bottom fuel oil tanks or in other bunker/double bottom fuel oil tanks, a program of additional close-up survey may be planned at the Society's discretion for the next inspections.

In other cases, such as coating found in poor condition or anodes depleted, repairs or renewal are to be dealt with, or a program of maintenance is to be set in agreement with the Society, at a suitable time, but at the latest at the next intermediate or class renewal survey, whichever comes first.

## 3.5 Inspection reports

**3.5.1** Inspection reports are to be prepared by the person responsible after each survey. They are to be kept on board and made available to the Surveyor at his request.

**3.5.2** The inspection reports are to include the following.

- General information such as date of inspection/maintenance, identification of the person performing the inspection with his signature, identification of the area/space/equipment inspected.
- For inspection of structural elements (deck area, hatch covers and small hatches, superstructures, ballast tanks, dry cargo holds and spaces, other spaces), the report is to indicate:
  - coating condition of the different boundaries and internal structures and, if any, coating repairs
  - structural defects, such as fractures, corrosion (including pitting), deformations, with the identification of their location, recurrent defects
  - condition of fittings related to the space inspected, with description as necessary of checks, working tests, dismantling, overhaul
- For inspection of equipment (deck equipment, sea connections and overboard discharges), the report is to indicate the results of visual examination, working tests, dismantling, repairs, renewal or overhaul performed.

**3.5.3** When deemed necessary or appropriate, the report is to be supplemented by documents, sketches or photographs, showing for example:

- location and dimension of fractures, pitting, deformations
- condition of equipment before repairs
- measurements taken.

**3.5.4** Models of inspection reports for structural elements and equipment are given in Ch 1, App 4.

These models are to be used as a guide for entering the collected data into the ship database, in an electronic form.

## 3.6 Changes to Inspection and Maintenance Plan

**3.6.1** Changes to ship operation, review of the inspection and maintenance reports, possible subsequent changes to the hot spot map and corrosion rates different than those expected may show that the extent of the maintenance performed needs to be adjusted to improve its efficiency.

Where more defects are found than would be expected, it may be necessary to increase the extent and/or the frequency of the maintenance program. Alternatively, the extent and/or the frequency of the maintenance may be reduced subject to documented justification.

# 4 Acceptance criteria

## 4.1 Coating assessment

### 4.1.1 Criteria

The acceptance criteria for the coating condition of each coated space is indicated in Tab 2.

Where acceptance criteria are not fulfilled, coating is to be repaired.

**Table 2 : Acceptance criteria for coatings**

Condition	Acceptance criteria
Ships less than 10 years old	Coatings in GOOD condition
Ships 10 years old or more	Coatings in GOOD or FAIR condition
<b>Note 1:</b> GOOD : Only minor spot rusting FAIR : Local breakdown at edges of stiffeners and weld connections and/or light rusting over 20% or more of areas under consideration, but less than as defined for POOR condition POOR : General breakdown of coating over 20% or more of areas or hard scale at 10% or more of areas under consideration.	

### 4.1.2 Repairs

The procedures for repairs of coatings are to follow the coating manufacturer's specification for repairs, under the Owner's responsibility.

## 4.2 Sacrificial anode condition

### 4.2.1 Criteria

The acceptance criteria for sacrificial anodes in each coated space fitted with anodes is indicated in Tab 3 in terms of percentage of losses in weight.

Where acceptance criteria are not fulfilled, sacrificial anodes are to be renewed.

**Table 3 : Acceptance criteria for sacrificial anodes**

Condition	Percentage of loss in weight
Ships less than 10 years old	Less than 25
Ships 10 years old or more	Less than 50

## 4.3 Thickness measurements

### 4.3.1 General

The acceptance criteria for measured thicknesses are indicated in:

- Ch 1, App 1 for isolated areas of items (for example a localised area of a plate)
- Ch 1, App 2 for items (for example a plating panel or an ordinary stiffener)
- Ch 1, App 3 for zones (for example the bottom zone).

When the acceptance criteria are not fulfilled, actions according to [4.3.2] to [4.3.4] are to be taken.

### 4.3.2 Isolated area

The thickness diminution of an isolated area of an item is the localised diminution of the thickness of that item such as, for example, the grooving of a plate or a web or a local severe corrosion. It is expressed as a percentage of the relevant as built thickness.

It is not to be confused with pitting (see [4.4]).

If the criteria of acceptable diminution are not fulfilled for an isolated area, then this isolated area is to be repaired or replaced. In any case, the criteria of thickness diminution are to be considered for the corresponding item (see [4.3.3]).

### 4.3.3 Item

For each item, thicknesses are measured at several points and the average value of these thicknesses is to satisfy the acceptance criteria for the relevant item.

If the criteria of measured thicknesses are not fulfilled for an item, then this item is to be repaired or replaced.

Where the criteria are fulfilled but substantial corrosion as defined in Pt A, Ch 2, Sec 2, [2.2.7] is observed, the IMP is to be modified by making adequate provision.

In any case, for the items which contribute to the hull girder longitudinal strength, the criteria in [4.3.4] are to be considered.

### 4.3.4 Zone

For consideration of the hull girder longitudinal strength, the transverse section of the ship is divided into three zones:

- deck zone
- neutral axis zone
- bottom zone.

The sectional area diminution of a zone, expressed as a percentage of the relevant as built sectional area, is to fulfil the criteria of acceptable diminution for that zone.

If the criteria of acceptable diminution are not fulfilled for a zone, then some items belonging to that zone are to be replaced (in principle, those which are most worn) in order to obtain after their replacement an increased sectional area of the zone fulfilling the relevant criteria.

## 4.4 Pitting

### 4.4.1 Pitting intensity

The pitting intensity is defined by the percentage of area affected by pitting.

The diagrams in Pt A, Ch 2, App 3 are to be used to identify the percentage of area affected by pitting and thus the pitting intensity.

### 4.4.2 Acceptable wastage

The acceptable wastage for a localised pit (intensity  $\leq 3\%$ ) is 23% of the average residual thickness.

For areas having a pitting density of 50% or more, the acceptable wastage in pits is 13% of the average residual thickness.

For intermediate values (between localised pit and 50% of affected area), the acceptable wastage in pits is to be obtained by interpolation between 23% and 13% of the average residual thicknesses (see Tab 4).

**Table 4 : Pitting intensity and corresponding acceptable wastage in pits**

Pitting intensity, in % (see Pt A, Ch 2, App 3)	Acceptable wastage in pits, in percentage of the average residual thickness
$\leq 3$	23
5	22
10	21
15	20
20	19
25	18
30	17
40	15
50	13



#### 4.4.3 Repairs

Application of filler material (plastic or epoxy compounds) is recommended as a mean for stopping/reducing the corrosion process but this is not an acceptable repair for pitting exceeding the maximum permissible wastage limits.

Welding repairs may be accepted when performed in accordance with agreed procedures.

### 4.5 Fractures

#### 4.5.1 General

Fractures are found, in general, at locations where stress concentrations occur.

In particular, fractures occur at the following locations:

- beginning or end of a run of welding
- rounded corners at the end of a stiffener

- traces of lifting fittings used during the construction of the ship
- weld anomalies
- welding at toes of brackets
- welding at cut-outs
- intersections of welds
- intermittent welding at the ends of each length of weld.

The structure under examination is to be cleaned and provided with adequate lighting and means of access to facilitate the detection of fractures.

If the initiation points of the fractures are not apparent, the structure on the other side of the plating is to be examined.

#### 4.5.2 Criteria

Where fractures are detected, the Society's Surveyor is always to be called for attendance.

## SECTION 3

## STAR-MACH, STAR-MACH SIS

### 1 General

#### 1.1 Application

**1.1.1** The additional class notations **STAR-MACH** and **STAR-MACH SIS** are assigned after construction, to ships complying with the requirements of this Section in accordance with Pt A, Ch 1, Sec 2. The notation **STAR-MACH SIS** is to be maintained during the ship service life.

#### 1.2 Definitions

##### 1.2.1 Risk Analysis

Risk analysis is a process of identifying assets and threats, prioritizing the related vulnerabilities, and identifying appropriate measures and protections in order to decrease these vulnerabilities to an acceptable level. On a ship, the risk analysis shall identify critical equipment in compliance with ISM Code, Section 10.

The most suitable risk analysis technique to be applied in this Section is the Reliability Centred Maintenance (RCM) methodology defined by or on behalf of the Operator, as described in [1.2.4]. Other risk analysis techniques providing an equivalent maintenance strategy may be recognized by the Society on a case by case basis. Condition monitoring techniques may be implemented.

##### 1.2.2 Operator

In this Section, Operator means the Owner of the vessel or any other organization or person, such as the Manager or the Bareboat Charterer, who declares to be in charge of the maintenance of the ship.

##### 1.2.3 Maintenance Management System

In this Section, the Operator's Maintenance Management System means the computerized support, as well as the content, that is the maintenance plan and the historical data.

##### 1.2.4 Reliability Centred Maintenance (RCM)

RCM is defined by the international recognized standards, such as SAE JA1011 "Evaluation Criteria for RCM Processes" and SAE JA 1012 "Guide to the Reliability Centred Maintenance (RCM) Standard" or IEC 60300-3-11 "Dependability management - Part 3-11: Application guide - Reliability centred maintenance".

It is a process used to select suitable failure management policies in order to ensure that any physical asset continues to function according to its performance standards and in its present operating context. It is generally used to achieve improvements in fields such as the establishment of safe minimum levels of maintenance, changes to operating procedures and strategies and the establishment of capital maintenance regimes and plans in order to increase the

probability that an asset will function in the required manner over its design life-cycle with a minimum amount of maintenance and downtime.

The RCM process generally consists of answering the seven basic questions for each asset or system under review:

- Function: What are the functions and associated performance standards of the asset in its present operating context?
- Functional Failure: In what ways does it fail to fulfil its functions?
- Failure Mode: What causes each functional failure?
- Failure Effect: What happens when each failure occurs?
- Consequence: In what way does each failure matter?
- Pro-active task: What can be done to predict or prevent each failure?
- Default task: What should be done if a suitable proactive task cannot be found?

#### 1.3 Scope

**1.3.1** The scope of **STAR-MACH** and **STAR-MACH SIS** is limited to the ship propulsion and steering systems, auxiliaries (machinery, electrical). It includes class machinery items and excludes any statutory equipment. A typical list of systems covered by these additional class notations is presented below:

- propulsion plant, including thrusters if any
- actuating systems of controllable pitch propellers
- electricity production and distribution
- cooling water systems
- lubricating oil transfer, treatment, supply systems
- fuel oil transfer, treatment, supply systems
- compressed air systems for starting and control
- hydraulic oil systems
- automation
- bilge system
- ballast / trimming / heeling systems
- fire detection and alarm system
- fire-fighting systems
- fuel / lubricating oil drainage / recovery
- exhaust gas systems
- steam production and distribution systems
- feed water and condensate systems
- thermal oil heating system
- steering gear system
- forced ventilation for machinery spaces, but excluding air conditioning
- waste pumping, but excluding treatment
- sewage pumping, but excluding treatment system.

## 1.4 Objectives

**1.4.1** The additional class notation **STAR-MACH** is assigned to a ship in order to reflect that a RCM study has been performed for the ship systems mentioned in [1.3], in order to support and validate the maintenance plan/program in the operational context.

**1.4.2** The additional class notation **STAR-MACH SIS** is assigned to a ship in order to reflect the following:

- a RCM study has been performed for the ship systems mentioned in [1.3], in order to support and validate the maintenance plan/program in the operational context
- the Operator, by taking into account the results of the RCM study, is able to demonstrate the effective implementation and follow-up of the approved maintenance plan/program
- the RCM study is periodically up-dated, usually at the class renewal survey, according to ship operation, maintenance and equipment behaviour (failures ...).

## 2 Assignment of the notation

### 2.1 Documentation to be submitted

**2.1.1** The following documentation is to be submitted to the Society for review (written either in English or in French):

- the Maintenance Plan, including information detailed in [2.1.3]
- the RCM study documentation in paper or electronic form, which should include the following:
  - Equipment or System selection methodology identifying critical equipment in compliance with ISM Code, Section 10 (if separate from the RCM process)
  - Operator RCM methodology or process (including operator maintenance philosophy and strategy) and reference to an applicable standard, such as the ones mentioned in [1.2.4]
  - Methodology for continuous improvement / tuning of the RCM study (in case the RCM study has already been updated before)
  - Qualifications of team involved in the RCM study (training and experience in RCM and equipment / system operation and maintenance)
  - Overview report of the RCM study – i.e. Number of systems, Number of equipment, number of completed, equipment types, level of details, etc (if available)
  - RCM study (Equipment Criticality Analysis, Functional Analysis, FME(C)A, Maintenance Selection Analysis, etc.) of each system including the sources used to collect the reliability data (see [2.1.5]).

The frequency of maintenance and its scope should be justified by Manufacturer's recommendations or from documented experience.

On a case by case basis, if the RCM study is not documented, the Society can carry out a RCM study, based on the submitted documentation as listed in [2.1.2].

**2.1.2** The following documentation is to be submitted to the Society for information regarding systems mentioned in [1.3]:

- Master Equipment List
- System drawings
- Specifications and operational description of systems/components.
- Equipment operation and maintenance manuals, on a case by case basis
- Attestation from the Operator stating that there are no design changes foreseen in the next 5 years at the date of the application for the **STAR-MACH** notation
- Historical data of equipment maintenance and failures (if any), see [2.1.4].

### 2.1.3 Maintenance Plan

The Operator is to provide a Maintenance Plan representing the collection of maintenance tasks together with the schedule of execution.

For each maintenance task, the following information must be made available:

- maintenance type (on-condition monitoring, inspection, reconditioning/overhauling, discarding/replacing, testing, routine, service and lubricating, testing/failure finding)
- maintenance frequency (periodicity value unit is to be clearly specified, i.e. hour, day, week, month, year)
- maintenance description/scope.

### 2.1.4 Historical data

The Operator is to provide the Society with the ship history reports for any piece of equipment on:

- carried-out preventive, preventive and failure finding maintenance (periodic or condition-based)
- damage or breakdown entailing unplanned maintenance (corrective)
- unsatisfactory condition found during maintenance.

Any recorded failure or breakdown should at least contain a detailed description of failure, date of occurrence, equipment counter hours at occurrence, possible cause.

### 2.1.5 Reliability Data Sources

The Operator is to provide the Society with the reliability data sources used during the RCM process. Reliability data sources could be, but are not limited to:

- Historical data (see [2.1.4])
- Experience of the RCM team members
- Data collected from previous RCM studies in similar systems
- Reliability databases (OREDA, ...)
- Manufacturer data, manuals or specifications.

## 2.2 STAR-MACH

**2.2.1** The procedure for the assignment of a **STAR-MACH** notation to a ship, on receipt of the documents listed in [2.1] regarding systems mentioned in [1.3], is as follows:

- a) The Society performs a documentation technical review of the RCM study, as described in [2.2.2], in order to approve the Maintenance Plan.

On a case by case basis, if the RCM study is not documented, the Society can carry out a RCM study based on the submitted documentation, in order to approve the Maintenance Plan.

- b) On approval of the maintenance plan, the **STAR-MACH** notation is assigned.

**2.2.2** The process of the RCM study technical review is:

- a) Verification that the Operator RCM methodology or process is based on an acceptable and applicable standard (including Equipment Criticality Analysis (ECA), Failure Modes and Effects Analysis (FMEA), and Maintenance Selection Analysis (MSA)).
- b) Verification that the RCM study team members have adequate skills and experience in undertaking RCM studies and are knowledgeable in the studied systems/equipment.
- c) Verification that the RCM study covers all the systems included in the scope.
- d) Verification that the most critical systems / equipment defined for the RCM study include some typical critical systems / equipment that would be expected for the ship and include equipment for which serious or frequent failures have been reported.
- e) Verification that all class machinery items are included in the scope of the RCM study.
- f) Carry out a review of the RCM study applied for selected main equipment of some systems, in order to check all possible scenarios in terms of criticality and maintenance strategies. If the review is acceptable and in accordance with the Operator RCM methodology, the RCM study of other equipment will not be fully reviewed. If considered unacceptable, a review of other equipment will be carried out for confirmation. If this review is also unacceptable, the Society will require a complete review of all other equipment.
- g) For the RCM study of each selected system / equipment, verification of the complete RCM process regarding:
- consistency with the Operator RCM methodology
  - completeness of equipment considered in the system (including controls, instrumentation and protective devices)
  - completeness of considered failure modes

- completeness and consistency of assigned maintenance strategy, assigned maintenance tasks and intervals with Failure Mode characteristics, criticality and related reliability data

- cross-references with the Maintenance Plan.

- h) Carry out a review of the Maintenance Plan: for most critical systems / equipment and class machinery items, verification that the submitted maintenance plan lists some typical maintenance tasks that would be expected for the relevant item from manufacturers' instructions, under any maintenance regime. These would include, but may not be limited to:

- equipment performance checks
- standard condition monitoring checks (vibrations, lubricant analysis, electrical characteristics, thermography, etc.)
- inspections of components liable to wear or other age related degradation, i.e., fouling
- periodic tests of instrumentation and protective devices.

- i) For most critical systems / equipment and/or class machinery items, where typical tasks have not been found in the submitted maintenance plan, review the RCM study for justification.

- j) Review any inconsistencies in maintenance task intervals included in the submitted maintenance plan.

## 2.3 STAR-MACH SIS

**2.3.1** The procedure for the assignment of a **STAR-MACH SIS** notation to a ship, on receipt of the documents listed in [2.1] regarding systems mentioned in [1.3], is as follows:

- a) The Society performs a documentation technical review of the RCM study, as described in [2.2.2], in order to approve the Maintenance Plan.

On a case by case basis, if the RCM study is not documented, the Society can carry out a RCM study, based on the submitted documentation, in order to approve the Maintenance Plan.

- b) An Implementation survey is carried out, on board the ship, as per the implementation survey performed in the scope of the Planned Maintenance Survey System described in Pt A, Ch 2, App 1, [5.1].

- c) On approval of the maintenance plan and completion of the Implementation survey, the **STAR-MACH SIS** notation is assigned.

## SECTION 4

## STAR-REGAS

### 1 General

#### 1.1 Application

**1.1.1** The additional class notation **STAR-REGAS** is assigned, after construction, to liquefied gas carriers assigned with the additional service feature **REGAS** (with or without **STL-SPM**) and complying with the requirements of this Section in accordance with Pt A, Ch 1, Sec 2. No requirements are provided for the maintenance of this notation during the ship's service life.

#### 1.2 Scope

**1.2.1** The scope of the **STAR-REGAS** notation is limited to the regasification installation, its associated systems and the send out systems. A typical list of systems covered by this additional class notation is presented below:

- regasification system
- send out system (HP gas manifold and/or Submerged Turret Loading system)
- heating system
- inert gas system
- vent and relief system
- automation
- fire and gas detection system for regasification and send out areas
- fire-fighting systems for regasification and send out areas
- electricity production and distribution for regasification and send out
- compressed air system for regasification and send out.

#### 1.3 Objectives

**1.3.1** The additional class notation **STAR-REGAS** is assigned to a liquefied gas carrier in order to reflect that a RCM study (see Ch 1, Sec 3, [1.2.1] and Ch 1, Sec 3, [1.2.4]) has been performed for the regasification installation and its associated systems, in order to support and validate the maintenance plan in the operating context.

### 2 Assignment of the notation

#### 2.1 Documentation to be submitted

**2.1.1** The following documentation is to be submitted to the Society for review (written either in English or in French):

- The RCM study documentations (see Ch 1, Sec 3, [2.1.1])
- The systems documentation (see Ch 1, Sec 3, [2.1.2])
- The Maintenance Plan, including information detailed in Ch 1, Sec 3, [2.1.3]
- The historical data of equipment maintenance and failures, if any, see Ch 1, Sec 3, [2.1.4].

#### 2.2 STAR-REGAS

**2.2.1** The procedure for the assignment of a **STAR-REGAS** notation to a liquefied gas carrier, on receipt of the documents listed in [2.1.1] regarding systems mentioned in [1.2] is as follows:

- a) the Society performs a documentation technical review of the RCM study, as described in Ch 1, Sec 3, [2.2.2], in order to approve the Maintenance Plan.  
On a case by case basis, if the RCM study is not documented, the Society can carry out the RCM study, based on the submitted documentation, in order to approve the Maintenance Plan.
- b) On approval of the maintenance plan, the **STAR-REGAS** notation is assigned.

## SECTION 5

## STAR-CARGO

### 1 General

#### 1.1 Application

**1.1.1** The additional class notation **STAR-CARGO** is assigned, after construction, to ships liable to carry cargoes (i.e cargo ships, bulk carriers, combination carriers, gas carriers, tankers, chemical tankers, oil tankers or other ships as relevant) complying with the requirements of this Section in accordance with Pt A, Ch 1, Sec 2, [4].

No requirements are provided for the maintenance of this notation during the ship's service life.

#### 1.2 Scope

**1.2.1** The scope of the **STAR-CARGO** notation is limited to the cargo handling installation and its associated systems, excluding structural elements part of cargo tanks and containment system.

#### 1.3 Objectives

**1.3.1** The additional class notation **STAR-CARGO** is assigned to a ship in order to reflect that a RCM study (see Ch 1, Sec 3, [1.2.1] and Ch 1, Sec 3, [1.2.4]), has been performed for the cargo handling installation and its associated systems in order to support and validate the maintenance plan in the operating context.

### 2 Assignment of the notation

#### 2.1 Documentation to be submitted

**2.1.1** The following documentation is to be submitted to the Society for review (written either in English or in French):

- The RCM study documentation (see Ch 1, Sec 3, [2.1.1])
- The systems documentation (see Ch 1, Sec 3, [2.1.2])
- The Maintenance Plan, including information detailed in Ch 1, Sec 3, [2.1.3]
- The historical data of equipment maintenance and failures, if any (see Ch 1, Sec 3, [2.1.4]).

#### 2.2 STAR-CARGO

**2.2.1** The procedure for the assignment of a **STAR-CARGO** notation to a ship, on receipt of the documents listed in [2.1.1] regarding systems mentioned in [1.2], is as follows:

- a) The Society performs a documentation technical review of the RCM study, as described in Ch 1, Sec 3, [2.2.2], in order to approve the Maintenance Plan.  
On a case by case basis, if the RCM study is not documented, the Society can carry out the RCM study, based on the submitted documentation, in order to approve the Maintenance Plan.
- b) On approval of the maintenance plan, the **STAR-CARGO** notation is assigned.

# APPENDIX 1

## ACCEPTANCE CRITERIA FOR ISOLATED AREAS OF ITEMS

### 1 General

#### 1.1 Application

**1.1.1** The acceptance criteria consist in checking that the thickness diminution of an isolated area of an item (measured according to Ch 1, Sec 2, [4.3.2]) is less than the acceptable limits specified in [1.1.2]. Otherwise, actions according to Ch 1, Sec 2, [4.3.2] are to be taken.

**1.1.2** The acceptable limits for the thickness diminution of isolated areas of items contributing to the hull girder longitudinal strength are specified in:

- Tab 1 for the bottom zone items
- Tab 2 for the neutral axis zone items
- Tab 3 for the deck zone items.

The acceptable limits for the thickness diminution of isolated areas of items not contributing to the hull girder longitudinal strength are specified in Tab 4.

**Table 1 : Acceptable limits for the thickness diminution of isolated areas of items contributing to the hull girder longitudinal strength and located in the bottom zone**

Item		Acceptable limit	
		L < 90 m	L ≥ 90 m
Plating of: <ul style="list-style-type: none"> <li>• keel, bottom and bilge</li> <li>• inner bottom</li> <li>• lower strake of inner side and longitudinal bulkheads</li> <li>• hopper tanks</li> </ul>		22%	18%
Longitudinal ordinary stiffeners of: <ul style="list-style-type: none"> <li>• keel, bottom and bilge</li> <li>• inner bottom</li> <li>• lower strake of inner side and longitudinal bulkheads</li> <li>• hopper tanks</li> </ul>	Web	22%	18%
	Flange	18%	15%
Longitudinal primary supporting members	Web	22%	18%
	Flange	18%	15%

**Table 2 : Acceptable limits for the thickness diminution of isolated areas of items contributing to the hull girder longitudinal strength and located in the neutral axis zone**

Item		Acceptable limit	
		L < 90 m	L ≥ 90 m
Plating of: <ul style="list-style-type: none"> <li>• side</li> <li>• inner side and longitudinal bulkheads</li> <li>• 'tweendecks</li> </ul>		22%	18%
Longitudinals ordinary stiffeners of: <ul style="list-style-type: none"> <li>• side</li> <li>• inner side and longitudinal bulkheads</li> <li>• 'tweendecks</li> </ul>	Web	22%	18%
	Flange	18%	15%
Longitudinal primary supporting members	Web	22%	18%
	Flange	18%	15%

**Table 3 : Acceptable limits for the thickness diminution of isolated areas of items  
Items contributing to the hull girder longitudinal strength and located in the deck zone**

Item		Acceptable limits	
		L < 90 m	L ≥ 90 m
Plating of: <ul style="list-style-type: none"> <li>• upper deck, stinger plate and sheerstrake</li> <li>• upper strake of inner side and longitudinal bulkheads</li> <li>• side in way of topside tank</li> <li>• topside tanks (lower horizontal part, sloping plate and upper vertical part)</li> </ul>		22%	18%
Longitudinal ordinary stiffeners of: <ul style="list-style-type: none"> <li>• upper deck, stringer plate and sheerstrake</li> <li>• upper strake of inner side and longitudinal bulkheads</li> <li>• side in way of topside tank</li> <li>• topside tanks (lower horizontal part, sloping plate and upper vertical part)</li> </ul>	Web	22%	18%
	Flange	18%	15%
Longitudinal primary supporting members	Web	22%	18%
	Flange	18%	15%

**Table 4 : Acceptable limits for the thickness diminution of isolated areas of items  
Items not contributing to the hull girder longitudinal strength**

Item		Acceptable limit	
		L < 90 m	L ≥ 90 m
Non-continuous hatch coamings	Plating	22%	18%
	Brackets	26%	22%
Hatch covers	Top plating	22%	18%
	Side and end plating	22%	18%
	Ordinary stiffeners	22%	18%
Plating of transverse bulkheads		22%	18%
Ordinary stiffeners of transverse bulkheads	Web	26%	22%
	Flange	22%	18%
	Brackets	26%	22%
Vertical primary supporting members and horizontal girders of bulkheads	Web	22%	18%
	Flange	18%	15%
	Brackets / stiffeners	22%	18%
Side frames	Web	22%	18%
	Flange	18%	15%
	Brackets / stiffeners	22%	18%
Deck and bottom transverse primary supporting members	Web	22%	18%
	Flange	18%	15%
	Brackets	22%	18%
Topside tank and hopper tank primary supporting members	Web	22%	18%
	Flange	18%	15%
Plating of the forward and aft peak bulkheads		22%	18%
Ordinary stiffeners of the forward and aft peak bulkheads	Web	26%	22%
	Flange	22%	18%
Cross ties	Web	22%	18%
	Flange	18%	15%
	Brackets / stiffeners	18%	15%



## APPENDIX 2

## ACCEPTANCE CRITERIA FOR ISOLATED ITEMS

## Symbols

$t_A$	: As-built thickness of plating, in mm	$w_M$	: Section modulus, in $\text{cm}^3$ , of ordinary stiffeners, to be calculated as specified in Pt B, Ch 4, Sec 3, [3.4] on the basis of the measured thicknesses of web, face plate and attached plating
$t_M$	: Measured thickness of plating, in mm	$w_R$	: Renewal section modulus, in $\text{cm}^3$ , of ordinary stiffeners i.e. the section modulus that an ordinary stiffener of a ship in service is to have to fulfil the yielding check, according to the strength principle in Pt B, Ch 4, Sec 3, [1.2.1]
$t_C$	: Corrosion additions, in mm, defined in Pt B, Ch 4, Sec 2, [3]	$t_{R,W}$	: Renewal thickness, in mm, of ordinary stiffener web, i.e. the web thickness that an ordinary stiffener of a ship in service is to have in order to fulfil the buckling check, according to the strength principle in Pt B, Ch 4, Sec 3, [1.3.2]. This thickness is to be calculated as specified in [3.2.2]
$t_{C1}, t_{C2}$	: Corrosion additions, in mm, defined in Pt B, Ch 4, Sec 2, [3] for the two compartments separated by the plating under consideration. For plating internal to a compartment, $t_{C1} = t_{C2} = t_C$	$t_{R,F}$	: Renewal thickness, in mm, of ordinary stiffener face plate, i.e. the face plate thickness that an ordinary stiffener of a ship in service is to have in order to fulfil the buckling check, according to the strength principle in Pt B, Ch 4, Sec 3, [1.3.2]. This thickness is to be calculated as specified in [3.2.2]
$t_R$	: Overall renewal thickness, in mm, of plating, in mm, defined in: <ul style="list-style-type: none"> <li>• [2.2.1] in general</li> <li>• [4.3.1] for the plating which constitutes primary supporting members</li> </ul>	$w_G$	: Rule gross section modulus, in $\text{cm}^3$ , of ordinary stiffeners, defined in [3.2.3]
$t_{R1}$	: Minimum renewal thickness, in mm, of plating defined in [2.2.2]	$WR_R$	: Re-assessment work ratio, defined in [4.2.1]
$t_{R2}$	: Renewal thickness, in mm, of plating subjected to lateral pressure or wheeled loads, i.e. the thickness that the plating of a ship in service is to have in order to fulfil the strength check, according to the strength principles in Pt B, Ch 4, Sec 3, [1.1]. This thickness is to be calculated as specified in [2.2.3]	$WR_A$	: As-built work ratio, defined in [4.2.2]
$t_{R3}$	: Compression buckling renewal thickness, in mm, i.e. the thickness that the plating of a ship in service is to have in order to fulfil the compression buckling check, according to the strength principles in Pt B, Ch 4, Sec 3, [1.3.1]. This thickness is to be calculated as specified in [2.2.4]	$t_{R5}$	: Yielding renewal thickness, in mm, of primary supporting members, i.e. the thickness that the plating which constitutes primary supporting members of a ship in service is to have in order to fulfil the yielding check, according to the strength principles in Pt B, Ch 4, Sec 3, [1.2.2]. This thickness is to be calculated as specified in [4.3.2]
$t_{R4}$	: Shear buckling renewal thickness, in mm, i.e. the thickness that the plating of a ship in service is to have in order to fulfil the shear buckling check, according to the strength principles in Pt B, Ch 4, Sec 3, [1.3.1]. This thickness is to be considered only for ships equal to or greater than 90 m in length and is to be calculated as specified in [2.2.5]	$t_{R6}$	: Buckling renewal thickness, in mm, of primary supporting members, i.e. the thickness that the plating which constitutes primary supporting members of a ship in service is to have in order to fulfil the buckling check, according to the strength principles in Pt B, Ch 4, Sec 3, [1.3.1]. This thickness is to be calculated as specified in [4.3.3]
$t_G$	: Rule gross thickness, in mm, of plating, defined in [2.2.6]	E	: Young's modulus, in $\text{N/mm}^2$ , to be taken equal to: <ul style="list-style-type: none"> <li>• for steels in general: <math>E = 2,06 \cdot 10^5 \text{ N/mm}^2</math></li> <li>• for stainless steels: <math>E = 1,93 \cdot 10^5 \text{ N/mm}^2</math></li> </ul>
$t_{A,W}$	: As built thickness of ordinary stiffener web, in mm		
$t_{A,F}$	: As built thickness of ordinary stiffener face plate, in mm		
$t_{M,W}$	: Measured thickness of ordinary stiffener web, in mm		
$t_{M,F}$	: Measured thickness of ordinary stiffener face plate, in mm		

$\nu$  : Poisson's ratio. Unless otherwise specified, a value of 0,3 is to be taken into account

$R_{eH}$  : Minimum yield stress, in N/mm<sup>2</sup>, of the material, defined in Pt B, Ch 4, Sec 1, [2]

$\gamma_m, \gamma_R, \gamma_{K1}, \dots, \gamma_{K9}$  : Partial safety factors, defined in [1].

## 1 Partial safety factors

### 1.1 General

1.1.1 The partial safety factors  $\gamma_m$  and  $\gamma_R$  are defined in:

- Pt B, Ch 7, Sec 1, [1.2], for plating
- Pt B, Ch 7, Sec 2, [1.2], for ordinary stiffeners
- Pt B, Ch 7, Sec 3, [1.4], for primary supporting members.

### 1.2 Partial safety factors based on the increased knowledge of the structure

#### 1.2.1 General

The partial safety factors  $\gamma_{K1}, \gamma_{K2}, \gamma_{K3}, \gamma_{K4}, \gamma_{K5}, \gamma_{K6}$  and  $\gamma_{K7}$  take into account the increased knowledge of the structural behaviour obtained through the surveys carried out on in-service ship structures and verification of their performances. Therefore, they have values equal to or less than 1,0 and apply to reduce the partial safety factor on resistance,  $\gamma_R$ , adopted in the strength checks of new ships (see Part B, Chapter 7).

### 1.2.2 Partial safety factors $\gamma_{K1}, \gamma_{K2}, \gamma_{K3}$ and $\gamma_{K4}$ for plating

These partial safety factors are to be calculated as specified in:

- [2.2.2] for minimum thicknesses ( $\gamma_{K1}$ )
- [2.2.3] for the strength checks of plate panels subjected to lateral pressure or wheeled loads ( $\gamma_{K2}$ )
- [2.2.4] for the compression buckling strength checks ( $\gamma_{K3}$ )
- [2.2.5] for the shear buckling strength checks ( $\gamma_{K4}$ ).

### 1.2.3 Partial safety factor $\gamma_{K5}$ for ordinary stiffeners

The partial safety factor for yielding checks of ordinary stiffeners ( $\gamma_{K5}$ ) is to be calculated as specified in [3.2.1].

### 1.2.4 Partial safety factors $\gamma_{K6}, \gamma_{K7}, \gamma_{K8}$ and $\gamma_{K9}$ for primary supporting members

These partial safety factors are to be calculated as specified in:

- [4.2.1] for reassessment structural analyses ( $\gamma_{K6}, \gamma_{K7}$ )
- [4.3.2] for yielding strength checks ( $\gamma_{K8}$ )
- [4.3.3] for buckling strength checks ( $\gamma_{K9}$ ).

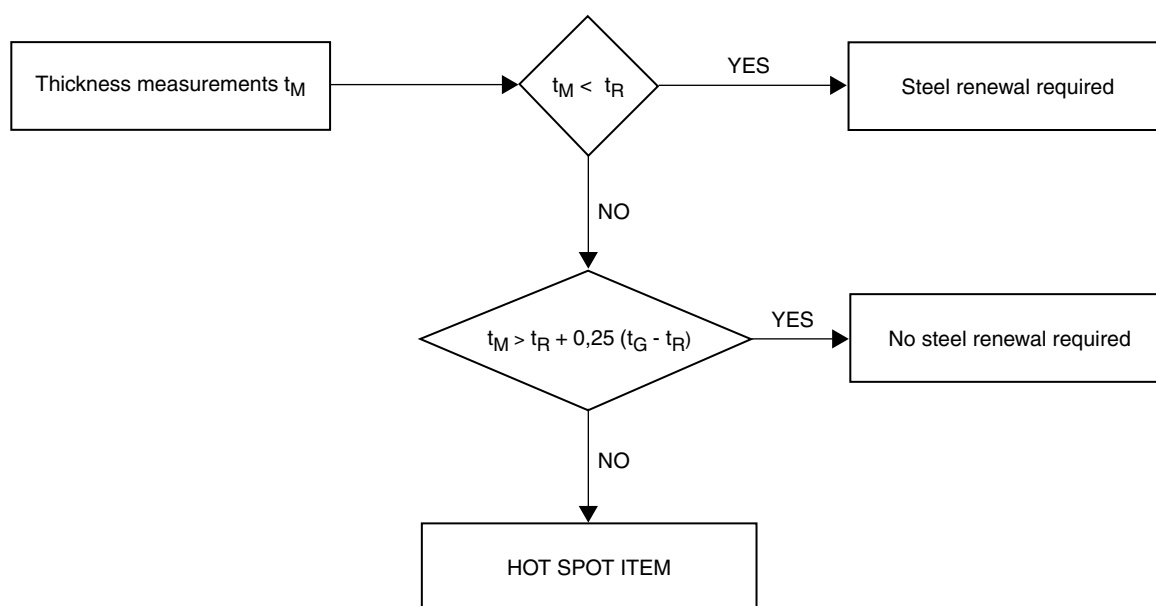
## 2 Acceptance criteria for plating

### 2.1 Application

#### 2.1.1 General

The acceptance criteria for measured thicknesses of plating, together with the application procedure to be adopted during the reassessment of hull structures, are indicated in Fig 1.

Figure 1: Acceptance criteria for measured thicknesses of plating and application procedure



**Table 1: Acceptance criteria to be applied in specific cases**

Ship type	Item	Rules to be applied
Ships with the service notation bulk carrier, of single side skin construction, having $L \geq 150$ m, intended for the carriage of bulk cargoes having dry bulk density equal to or greater than $1,0 \text{ t/m}^3$ , contracted for construction on or after 1 July 1998	Plating of vertically corrugated transverse watertight bulkheads	Pt A, Ch 2, App 3, Tab 4
Ships with the service notation bulk carrier, contracted for construction on or after 1 July 1998	Hatch cover plating	Pt A, Ch 2, App 3, Tab 4
Ships with the service notation bulk carrier, of single side skin construction, having $L \geq 150$ m, intended for the carriage of bulk cargoes having dry bulk density equal to or greater than $1,78 \text{ t/m}^3$ , contracted for construction prior to 1 July 1998	Plating of vertically corrugated transverse watertight bulkhead between cargo holds No. 1 and 2	Pt A, Ch 6, App 1, [2.6]

### 2.1.2 Specific cases

For the specific cases indicated in Tab 1, the acceptance criteria to be applied, in lieu of those in [2.1.1], are those specified in the Rules to which reference is made in the same table.

## 2.2 Renewal thicknesses

### 2.2.1 Overall renewal thickness

The overall renewal thickness is to be obtained, in mm, from the following formula:

$$t_R = \max(t_{R1}, t_{R2}, t_{R3}, t_{R4})$$

### 2.2.2 Minimum renewal thickness

The minimum renewal thickness is to be obtained, in mm, from the following formula:

$$t_{R1} = t_1 \gamma_{K1}$$

where:

$t_1$  : Minimum net thickness, in mm, to be calculated as specified in Pt B, Ch 7, Sec 1, [2.2]

$\gamma_{K1}$  : Partial safety factor (see [1.2.2]):

$$\gamma_{K1} = N_p \Psi_1$$

without being taken greater than 1,0

$N_p$  : Coefficient defined in Tab 2

$$\Psi_1 = 1 + \frac{t_{C1} + t_{C2}}{t_1}$$

### 2.2.3 Renewal thickness of plating subjected to lateral pressure or wheeled loads

The renewal thickness of plating subjected to lateral pressure or wheeled loads is to be obtained, in mm, from the following formula:

$$t_{R2} = t_2 \gamma_{K2}$$

where:

$t_2$  : Net thickness, in mm, to be calculated as specified in:

- Pt B, Ch 7, Sec 1, [3], for plating subjected to lateral pressure
- Pt B, Ch 7, Sec 1, [4], for plating subjected to wheeled loads

where the hull girder stresses are to be calculated considering the hull girder transverse sections constituted by elements (plating, ordinary stiffeners, primary supporting members) having their measured thicknesses and scantlings

$\gamma_{K2}$  : Partial safety factor (see [1.2.2]):

$$\gamma_{K2} = N_p \Psi_2$$

without being taken greater than 1,0

$N_p$  : Coefficient defined in Tab 2

$$\Psi_2 = 1 + \frac{t_{C1} + t_{C2}}{t_2}$$

**Table 2: Coefficient  $N_p$** 

Plating	Coefficient $N_p$	
	$L < 90$ m	$L \geq 90$ m
In general, including that which constitutes web of primary supporting members	0,75	0,80
Plating which constitutes face plate of primary supporting members	0,80	0,85
Bottom primary supporting members of ships with one of the service notations bulk carrier, ore carrier and combination carrier	0,80	0,85
Hatch coaming brackets	0,70	0,75
Cross ties of ships with the service notation oil tanker	0,80	0,85

### 2.2.4 Compression buckling renewal thickness

The compression buckling renewal thickness is to be obtained, in mm, from the following formula:

$$t_{R3} = t_3 \gamma_{K3}$$

where:

$t_3$  : Net thickness to be obtained, in mm, from the following formulae:

$$t_3 = \frac{b}{\pi} \sqrt{\frac{\sigma_{x1} \gamma_R \gamma_m 12 (1-v^2)}{EK_1 \epsilon}} 10^3 \quad \text{for } \gamma_m \gamma_R \sigma_{x1} \leq \frac{R_{eH}}{2}$$

$$t_3 = \frac{b}{\pi} \sqrt{\frac{3(1-v^2) R_{eH}^2}{EK_1 \epsilon (R_{eH} - \sigma_{x1} \gamma_R \gamma_m)}} 10^3 \quad \text{for } \gamma_m \gamma_R \sigma_{x1} > \frac{R_{eH}}{2}$$

$b$  : Length, in m, of the plate panel side, defined in Pt B, Ch 7, Sec 1, [5.1.2]

$\sigma_{x1}$  : In plane hull girder normal stress, in N/mm<sup>2</sup> to be calculated as specified in Pt B, Ch 7, Sec 1, [5.2.2], considering the hull girder transverse sections as being constituted by elements (plating, ordinary stiffeners, primary supporting members) having their measured thicknesses and scantlings

$\epsilon, K_1$  : Coefficients defined in Pt B, Ch 7, Sec 1, [5.3.1]

$\gamma_{K3}$  : Partial safety factor (see [1.2.2]):

$$\gamma_{K3} = N_p \Psi_3$$

without being taken greater than 1,0

$N_p$  : Coefficient defined in Tab 2

$$\Psi_3 = 1 + \frac{t_{C1} + t_{C2}}{t_3}$$

### 2.2.5 Shear buckling renewal thickness

The shear buckling renewal thickness is to be obtained, in mm, from the following formula:

$$t_{R4} = t_4 \gamma_{K4}$$

where:

$t_4$  : Net thickness to be obtained, in mm, from the following formulae:

$$t_4 = \frac{b}{\pi} \sqrt{\frac{\tau_1 \gamma_R \gamma_m 12 (1-v^2)}{EK_2}} 10^3 \quad \text{for } \gamma_m \gamma_R \tau_1 \leq \frac{R_{eH}}{2\sqrt{3}}$$

$$t_4 = \frac{b}{\pi} \sqrt{\frac{\sqrt{3}(1-v^2) R_{eH}^2}{EK_2 (R_{eH} - \sqrt{3} \tau_1 \gamma_R \gamma_m)}} 10^3 \quad \text{for } \gamma_m \gamma_R \tau_1 > \frac{R_{eH}}{2\sqrt{3}}$$

$b$  : Length, in m, of the plate panel side, defined in Pt B, Ch 7, Sec 1, [5.1.3]

$\tau_1$  : In plane hull girder shear stress, in N/mm<sup>2</sup>, to be calculated as specified in Pt B, Ch 7, Sec 1, [5.2.3], considering the hull girder transverse sections as being constituted by elements (plating, ordinary stiffeners, primary supporting members) having their measured thicknesses and scantlings

$K_2$  : Coefficient defined in Pt B, Ch 7, Sec 1, [5.3.2]

$\gamma_{K4}$  : Partial safety factor (see [1.2.2]):

$$\gamma_{K4} = N_p \Psi_4$$

without being taken greater than 1,0

$N_p$  : Coefficient defined in Tab 2

$$\Psi_4 = 1 + \frac{t_{C1} + t_{C2}}{t_4}$$

### 2.2.6 Rule gross thickness

The rule gross thickness is to be obtained, in mm, from the following formula:

$$t_G = \max(t_1, t_2, t_3, t_4) + t_{C1} + t_{C2}$$

where  $t_1, t_2, t_3$  and  $t_4$  are the net thicknesses defined in [2.2.2], [2.2.3], [2.2.4] and [2.2.5], respectively.

## 3 Acceptance criteria for ordinary stiffeners

### 3.1 Application

**3.1.1** The acceptance criteria for measured scantlings of ordinary stiffeners, together with the application procedure to be adopted during the reassessment of hull structures, are indicated in Fig 2.

### 3.2 Renewal scantlings

#### 3.2.1 Renewal section modulus

The renewal section modulus is to be obtained, in cm<sup>3</sup>, from the following formula:

$$W_R = W_Y \gamma_{K5}$$

where:

$W_Y$  : Net section modulus, in cm<sup>3</sup>, to be calculated as specified in Pt B, Ch 7, Sec 2, [3], where the hull girder stresses are to be calculated considering the hull girder transverse sections constituted by elements (plating, ordinary stiffeners, primary supporting members) having their measured thicknesses and scantlings

$\gamma_{K5}$  : Partial safety factor (see [1.2.3]):

$$\gamma_{K5} = N_s \Psi_5$$

without being taken greater than 1,0

$N_s$  : Coefficient defined in Tab 3

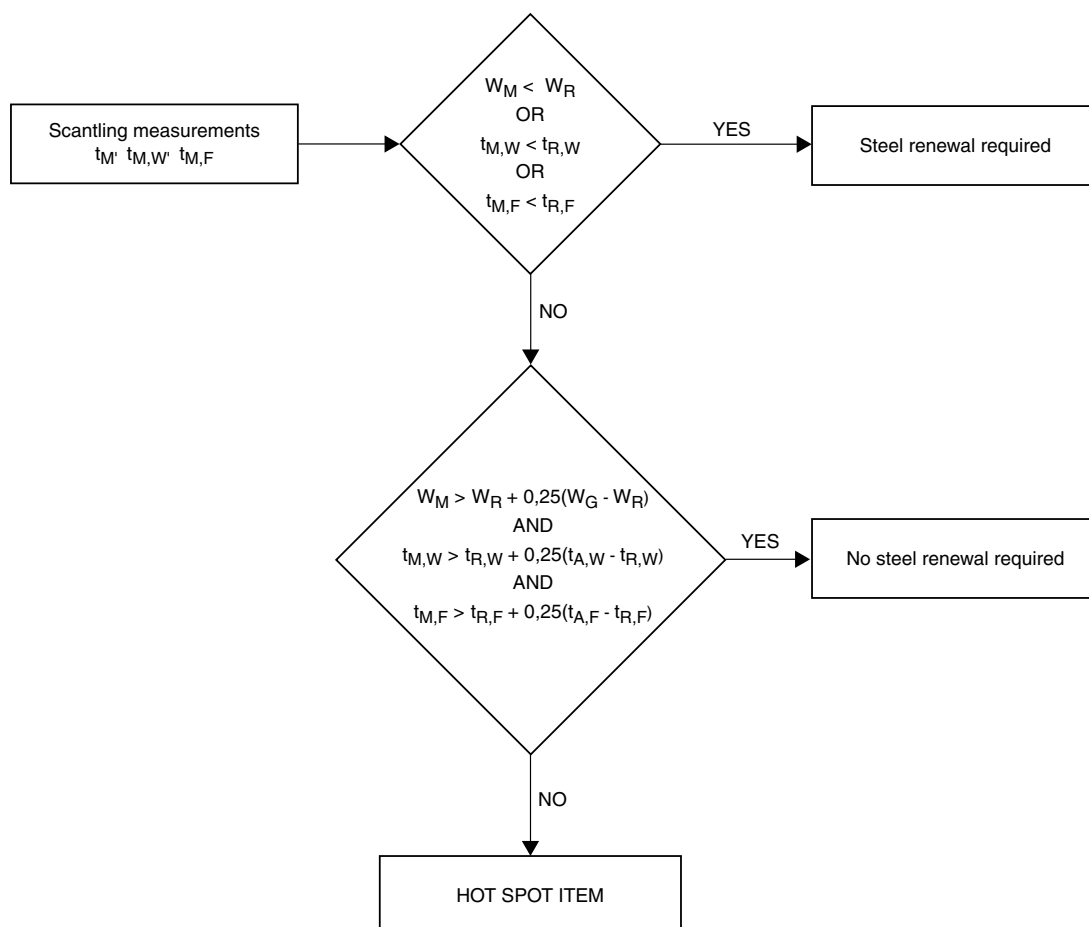
$$\Psi_5 = \frac{1 + \frac{\beta t_C}{W_Y}}{1 - \alpha t_C}$$

$\alpha, \beta$  : Parameters, depending on the type of ordinary stiffener, defined in Pt B, Ch 4, Sec 2, Tab 1.

**Table 3 : Coefficient  $N_s$**

Ordinary stiffeners	Coefficient $N_s$	
	$L < 90$ m	$L \geq 90$ m
Flat bars and bulb profiles	0,75	0,80
Flanged profiles	0,80	0,81

Figure 2: Acceptance criteria for measured scantlings of ordinary stiffeners and application procedure



### 3.2.2 Renewal web and face plate thicknesses

The renewal web and face plate thicknesses are to be obtained, in mm, from the following formulae:

$$t_{R,W} = h_W / C_W$$

$$t_{R,F} = b_F / C_F$$

where:

$h_W$  : Web height, in mm

$b_F$  : Face plate breadth, in mm

$C_W, C_F$  : Coefficients depending on the type and material of ordinary stiffeners, defined in Tab 4.

In any case, the renewal web and face plate thicknesses are to be not less than those obtained according to Pt A, Ch 2, App 3, [4].

### 3.2.3 Rule gross section modulus

The rule gross section modulus is to be obtained, in cm<sup>3</sup>, from the following formula:

$$w_G = \frac{w_R + \beta t_C}{1 - \alpha t_C}$$

where:

$\alpha, \beta$  : Parameters, depending on the type of ordinary stiffener, defined in Pt B, Ch 4, Sec 2, Tab 1

$w_{N,R}$  : Net section modulus, in cm<sup>3</sup>, defined in [3.2.1].

Table 4: Coefficients  $C_W$  and  $C_F$

Type of ordinary stiffeners	$C_W$			$C_F$		
	$R_{eH} = 235$	$R_{eH} = 315$	$R_{eH} = 355$	$R_{eH} = 235$	$R_{eH} = 315$	$R_{eH} = 355$
Flat bar	20	18	17,5	Not applicable		
Bulb	56	51	49	Not applicable		
With symmetrical face plate	56	51	49	34	30	29
With non-symmetrical face plate	56	51	49	17	15	14,5

Note 1:  $R_{eH}$  is given in N/mm<sup>2</sup>.

## 4 Acceptance criteria for primary supporting members

### 4.1 Application

4.1.1 The acceptance criteria for measured scantlings of primary supporting members and the application procedure to be adopted during the reassessment of hull structures are indicated in Fig 3.

### 4.2 Work ratios

#### 4.2.1 Reassessment work ratio

The reassessment work ratio is to be obtained from the following formula:

$$WR_R = \max(\gamma_{K6}WR_Y, \gamma_{K7}WR_B)$$

where:

$\gamma_{K6}$  : Partial safety factor (see [1.2.4]):

$$\gamma_{K6} = 0,9$$

$\gamma_{K7}$  : Partial safety factor (see [1.2.4]):

$$\gamma_{K7} = 1,0$$

$WR_Y$  : Yielding work ratio, defined in [4.2.3]

$WR_B$  : Buckling work ratio, defined in [4.2.4].

#### 4.2.2 As-built work ratio

The as-built work ratio is to be obtained from the following formula:

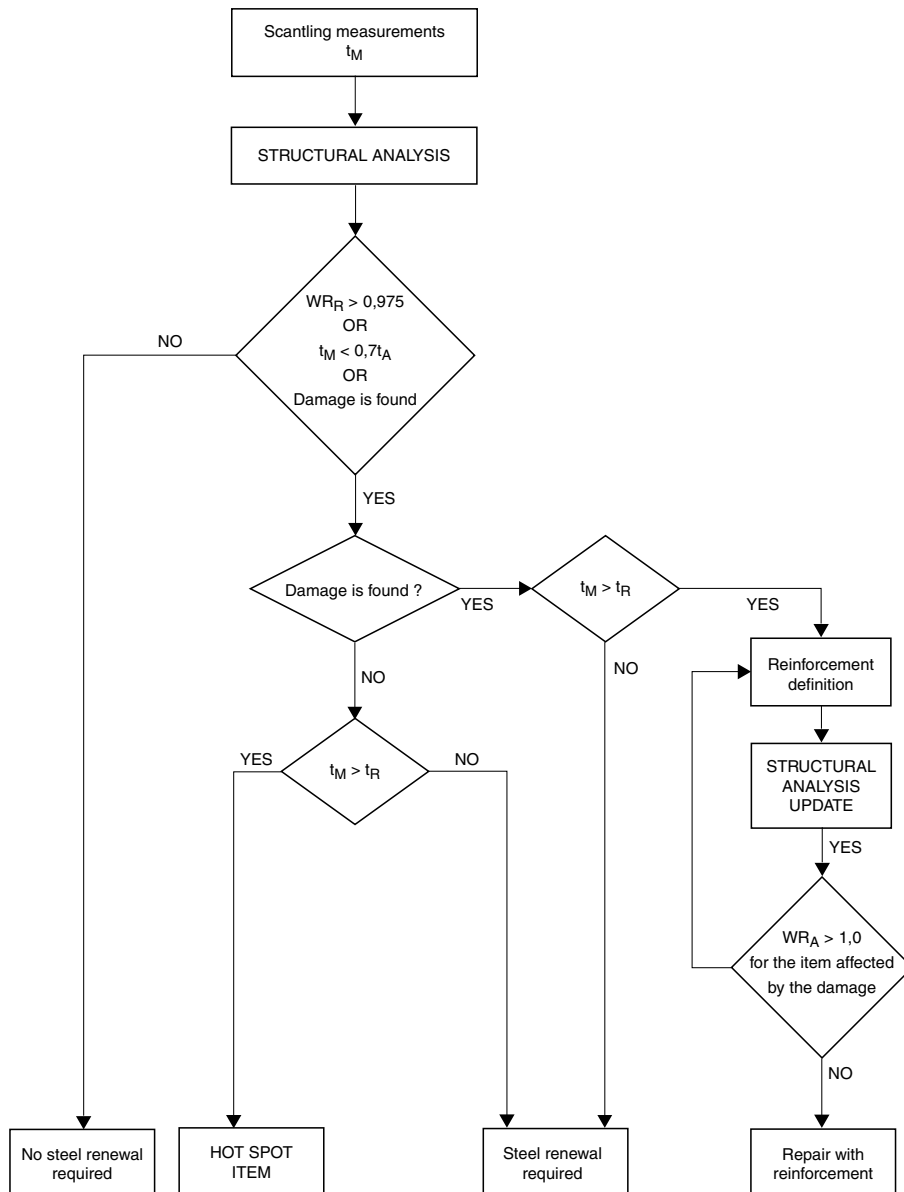
$$WR_A = \max(WR_Y, WR_B)$$

where:

$WR_Y$  : Yielding work ratio, defined in [4.2.3]

$WR_B$  : Buckling work ratio, defined in [4.2.4].

Figure 3: Application procedure for reassessment of the hull structure



### 4.2.3 Yielding work ratio

The yielding work ratio is to be obtained from the following formula:

$$WR_Y = \frac{\gamma_R \gamma_m \sigma_{VM}}{R_y}$$

where:

- $\sigma_{VM}$  : Equivalent stress, in N/mm<sup>2</sup>, to be calculated as specified in Pt B, Ch 7, App 1, [5.1.2], considering the hull structure as being constituted by elements (plating, ordinary stiffeners, primary supporting members) having their measured thicknesses and scantlings for the calculation of  $WR_R$  and net scantlings according to Pt B, Ch 4, Sec 2 for the calculation of  $WR_A$  and renewal thickness
- $R_y$  : Minimum yield stress, in N/mm<sup>2</sup>, of the material, to be taken equal to 235/k N/mm<sup>2</sup>
- k : Material factor, defined in Pt B, Ch 4, Sec 1, [2.3].

### 4.2.4 Buckling work ratio

The buckling element work ratio is to be obtained from the following formula:

$$WR_B = \max(WR_{B1}, WR_{B2}, WR_{B3}, WR_{B4})$$

where:

$WR_{B1}$  : Compression buckling work ratio:

$$WR_{B1} = \frac{\gamma_R \gamma_m \sigma_b}{\sigma_c}$$

$WR_{B2}$  : Shear buckling work ratio:

$$WR_{B2} = \frac{\gamma_R \gamma_m \tau_b}{\tau_c}$$

$WR_{B3}$  : Compression, bending and shear buckling work ratio:

$$WR_{B3} = \frac{F}{F_c}$$

$WR_{B4}$  : Bi-axial compression and shear buckling work ratio:

$$WR_{B4} = \left( \frac{\gamma_R \gamma_m \sigma_a}{\sigma_{c,a}} \right)^{1,9} + \left( \frac{\gamma_R \gamma_m \sigma_b}{\sigma_{c,b}} \right)^{1,9} + \left( \frac{\gamma_R \gamma_m \tau_b}{\tau_c} \right)^{1,9}$$

$\sigma_a, \sigma_b, \tau_b$ : Normal and shear stresses, in N/mm<sup>2</sup>, defined in Pt B, Ch 7, Sec 1, [5.4]

$\sigma_c, \tau_c$  : Critical buckling stresses, in N/mm<sup>2</sup>, defined in Pt B, Ch 7, Sec 1, [5.3]

F : Coefficient defined in Pt B, Ch 7, Sec 1, [5.4.4]

$F_c$  : Coefficient to be obtained from the following formula:

$$\text{for } \frac{\sigma_{comb}}{F} \leq \frac{R_{eH}}{2\gamma_R \gamma_m} :$$

$$F_c = 1$$

$$\text{for } \frac{\sigma_{comb}}{F} > \frac{R_{eH}}{2\gamma_R \gamma_m} :$$

$$F_c = \frac{4\sigma_{comb}}{R_{eH}/\gamma_R \gamma_m} \left( 1 - \frac{\sigma_{comb}}{R_{eH}/\gamma_R \gamma_m} \right)$$

$\sigma_{comb}$  : Combined stress in N/mm<sup>2</sup>, defined in Pt B, Ch 7, Sec 1, [5.4.4]

$\sigma_{c,a}, \sigma_{c,b}$  : Critical buckling stresses, in N/mm<sup>2</sup>, defined in Pt B, Ch 7, Sec 1, [5.4.5]

The above quantities are to be calculated considering the hull structure as being constituted by elements (plating, ordinary stiffeners, primary supporting members) having their measured thicknesses and scantlings for the calculation of  $WR_R$  and net scantlings according to Pt B, Ch 4, Sec 2 for the calculation of  $WR_A$  and renewal thickness.

## 4.3 Renewal scantlings

### 4.3.1 Overall renewal thickness

The overall renewal thickness may be obtained without prior knowledge of the thickness measurements, from the following formula, in mm:

$$t_R = \max(t_{RY}, t_{RB}, 0,7 t_A)$$

### 4.3.2 Yielding renewal thickness

The yielding renewal thickness is to be obtained, in mm, from the following formula:

$$t_{RY} = t_Y \gamma_{K8}$$

where:

$t_Y$  : Net thickness to be obtained, in mm, from the following formula:

$$t_Y = [t_A - 0,5(t_{C1} + t_{C2})] WR_Y$$

$WR_Y$  : Yielding work ratio, defined in [4.2.3]

$\gamma_{K8}$  : Partial safety factor (see [1.2.4]):

$$\gamma_{K8} = N_p \Psi_Y$$

$N_p$  : Coefficient defined in Tab 2

$$\Psi_Y = 1 + \frac{0,5(t_{C1} + t_{C2})}{t_Y}$$

### 4.3.3 Buckling renewal thickness

The buckling renewal thickness is to be obtained, in mm, from the following formula:

$$t_{RB} = t_B \gamma_{K9}$$

where:

$t_B$  : Net thickness to be obtained, in mm, from the following formula:

$$t_B = [t_A - 0,5(t_{C1} + t_{C2})] \sqrt[3]{WR_B}$$

$WR_B$  : Buckling work ratio, defined in [4.2.4]

$\gamma_{K9}$  : Partial safety factor (see [1.2.4]):

$$\gamma_{K9} = N_p \Psi_B$$

$N_p$  : Coefficient defined in Tab 2

$$\Psi_B = 1 + \frac{0,5(t_{C1} + t_{C2})}{t_B}$$

## APPENDIX 3

## ACCEPTANCE CRITERIA FOR ZONES

### 1 General

#### 1.1 Application

**1.1.1** The acceptance criteria consist in checking that the sectional area diminution of a zone (measured according to Ch 1, Sec 2, [4.3.4]) is less than the acceptable limits specified in [1.1.2]. Otherwise, actions according to Ch 1, Sec 2, [4.3.4] are to be taken.

**1.1.2** The acceptable limits for the sectional area diminution of zones are specified in Tab 1.

**Table 1 : Acceptable limits for the sectional area diminution of zones**

Zone		Acceptable limit
Bottom zone		7%
Neutral axis zone	Side	11%
	Inner side and longitudinal bulkheads	11%
Deck zone		7%



## APPENDIX 4

## OWNER'S HULL INSPECTION REPORTS

### 1 General

#### 1.1

##### 1.1.1 Application

As stated in Ch 1, Sec 2, [3.5], inspection reports are to be prepared by the Owner's person responsible each time an inspection is carried out within the scope of the Inspection and Maintenance Plan. Two models of inspection report are provided for this purpose:

- one model for inspection of spaces (applicable to inspection of deck area structure, ballast tanks, dry cargo holds and spaces, superstructures and other accessible compartments)
- one model for inspection of hull equipment (applicable to hatch covers and small hatches, deck equipment, sea connections and overboard discharges).

One separate inspection report is to be issued for each different space or equipment inspected.

##### 1.1.2 Use of models

The Owner is to adapt these models, so far as practicable and appropriate, to the ship concerned, the spaces to be inspected and the existing equipment. However, the general content of the report and its layout are to comply with the models.

### 2 Report for inspection of spaces

#### 2.1 General

**2.1.1** The model of Owner's report for space inspection is given in Tab 1.

**2.1.2** The report is divided into four parts:

- general identification data
- summary of findings and repairs for the different areas of the space and for the fittings in this space
- details of findings and repairs, as applicable
- additional documentation attached to the report.

#### 2.2 Identification data

**2.2.1** The identification data are to give the information about the space inspected, date and place of inspection and

name of the person under whose responsibility the inspection has been carried out.

**2.2.2** The identification of the space is to be such that:

- it is easy to trace the space concerned, in particular in cases where several identical spaces exist on the ship
- the same identification is used for the subsequent inspection reports pertaining to the same space.

#### 2.3 Summary of findings and repairs

**2.3.1** Each space inspected is divided into items corresponding to:

- the different boundaries of the space
- the internal structure of the space
- the fittings of the space.

For better understanding, the second column of the table may be used to clarify which elements belong to each item or which fittings are concerned.

**2.3.2** For each item, as applicable, the summary table is to give a general answer to the findings and to the possible repairs made.

- When coating condition is concerned, the answer is to be either "no coating", or "good", or "fair", or "poor", as per the definition of such conditions given in Pt A, Ch 2, Sec 2.
- Anode condition is to be answered by giving an estimated average loss of weight as a percentage, bearing in mind the acceptance criteria given in Ch 1, Sec 2, [4].
- The other columns (fractures, general corrosion, pitting/grooving, deformations, repairs) are to be answered "yes" or "no", depending on whether or not such defect/repair has been found/performed.
- The column "other" is to be used to indicate whether another type of inspection has been carried out, such as thickness measurement, pressure test or working test.

#### 2.4 Details of findings and repairs

**2.4.1** Each time the answer in the summary table is "poor" for coating, or "yes" for other topics, this part of the report is to be used to give details on the findings, defects or repairs concerned.

**Table 1: Owner's report for space inspection**

Person responsible:	
Date of inspection:	Place of inspection:
Name of ship:	Register number:
Name and type of space:	Location (port/stbd, from frame ... to frame ...):

Structure area, fittings	Items in the area	Coating /anode condition	Fractures	General corrosion	Pitting or grooving	Deformations	Repairs	Other
Top								
Bottom								
Port side								
Stbd side								
Forward bulkhead								
Aft bulkhead								
Internal structure								
Fittings								

Findings during inspection: (location, type, details)	Action taken: required repair, temporary repair, permanent repair (location, type and extent)
Other documentation attached to the report : sketches [ ], photos [ ], thickness measurement report [ ], other [ ]	

**2.4.2** As guidance, the following details are to be given:

- for coating found in poor condition:  
structural elements concerned, type of coating defect (breakdown, hard scale)
- for fractures:  
location of fractures, dimension, number of identical fractures
- for general corrosion:  
structural elements concerned, extent of wastage on these elements, estimation of wastage (if thickness measurements have been taken)
- for pitting/grooving:  
structural elements concerned and location, depth of pitting/grooving, percentage of affected surface using diagrams in Appendix 5, length of grooving
- for deformations:  
type of deformation (buckling, external cause), location of the deformation and structural elements concerned, estimation of size
- for repairs (if performed without the attendance of a Surveyor, when this is possible or acceptable):  
type of repairs, elements or areas concerned.

## 2.5 Attached documentation

**2.5.1** It is recommended that the report is supported by attaching sketches, photos, the thickness measurement report or other documentation, when this is deemed necessary to clarify the findings and/or repairs given in the detailed part.

For example:

- photos may be used to show the condition of the coating and anodes, the extent of general corrosion, pitting and grooving, or the appearance and extent of fractures
- sketches may be used to indicate fractures, deformations and repairs, especially when a photo cannot encompass the whole image and give a complete representation.

## 3 Report for inspection of equipment

### 3.1 General

**3.1.1** The model of Owner's report for equipment inspection is given in Tab 2.

**3.1.2** The report is divided into three parts:

- general identification data
- detailed report of findings and repairs
- additional documentation attached to the report.

### 3.2 Identification data

**3.2.1** The identification data are to give the information about the equipment inspected, date and place of inspection and name of the person under whose responsibility the inspection has been carried out.

**3.2.2** The identification of the equipment is to be such that:

- it is easy to trace the item of equipment concerned, in particular in cases where several identical items of equipment exist on the ship
- the same identification is used for the subsequent inspection reports pertaining to the same item of equipment.

### 3.3 Detailed report

**3.3.1** The detailed report of inspection is divided into three parts:

- inspection done:
  - the type of inspection carried out:  
visual external examination, internal examination after dismantling, overhaul
  - readings performed, when applicable:  
clearances, thickness measurements, working pressure, or other working parameters of the equipment
  - findings during the inspection:  
corrosion, fractures, pieces of equipment worn out, broken or missing.
- maintenance done, repairs carried out and pieces renewed
- results of tests performed after the inspection, such as working test, pressure test, hose test or equivalent for hatch covers or other weathertight fittings, sea trials.

### 3.4 Attached documentation

**3.4.1** It is recommended that the report is supported by attaching sketches, photos, the thickness measurement report or other documentation, when this is deemed necessary to clarify the findings and/or repairs given in the detailed part.

For example:

- photos may be used to show the condition of the pieces of equipment before their overhaul or renewal, the coating condition of piping, or the extent of corrosion
- sketches may be used to indicate fractures and deformations, clearances taken, or other measurements performed.

**Table 2 : Owner's report for equipment inspection**

Person responsible:	
Date of inspection:	Place of inspection:
Name of ship:	Register number:
Name and type of equipment:	Location (port/stbd, at frame ..., ...):

Type of inspection, findings and readings:

Repairs, maintenance, pieces renewed:

Working tests, pressure test, trials, ... :

Other documentation attached to the report :  
 sketches [ ], photos [ ], thickness measurement report [ ], other [ ]

## **AVAILABILITY OF MACHINERY (AVM)**

---

- SECTION 1 ALTERNATIVE PROPULSION SYSTEM (AVM-APS)**
- SECTION 2 DUPLICATED PROPULSION SYSTEM (AVM-DPS)**
- SECTION 3 INDEPENDENT PROPULSION SYSTEMS (AVM-IPS)**
- SECTION 4 FIRE MITIGATION FOR MAIN DIESEL-GENERATOR ROOMS (AVM-FIRE)**
- APPENDIX 1 PROCEDURES FOR FAILURE MODES AND EFFECT ANALYSIS**



## SECTION 1

## ALTERNATIVE PROPULSION SYSTEM (AVM-APS)

### 1 General

#### 1.1 Application

**1.1.1** The additional class notation **AVM-APS** is assigned in accordance with Pt A, Ch 1, Sec 2, [6.3.2] to self propelled ships arranged with means for alternative propulsion system complying with the requirements of this Section.

**1.1.2** Installation of machinery and electrical systems is to comply with relevant provisions of Part C.

**1.1.3** The alternative propulsion system is an arrangement of machinery suitable to maintain the ship in operating condition in case of loss of the main propulsion system.

The alternative propulsion system may be used either to allow the ship to reach the first suitable port or place of refuge, or to escape from severe environment, allowing minimum services for navigation, safety, preservation of cargo and habitability.

**1.1.4** Alternative propulsion system is to be designed for permanent operation with unrestricted working duration.

#### 1.2 Definitions

##### 1.2.1 Main propulsion system

The main propulsion system is a system that provides thrust to the ship in normal condition of operation. It includes:

- the prime mover, including the integral equipment, driven pumps, etc.
- the equipment intended to transmit the torque
- the propulsion electric motor, where applicable
- the equipment intended to convert the torque into thrust
- the auxiliary systems necessary for operation
- the control, monitoring and safety systems.

##### 1.2.2 Alternative propulsion system

The alternative propulsion system is a system that provides thrust of the ship in emergency conditions, when the main propulsion system becomes unavailable after a failure. It may be supplied either by a stand-by emergency engine or electric motor, or by a shaft generator, provided it has been designed for readily reversible operation as propulsion motor, in the case of loss of the main engine.

The alternative propulsion system also includes the following associated systems:

- the equipment intended to convert the torque into thrust
- the auxiliary systems necessary for operation
- the control, monitoring and safety systems.

##### 1.2.3 Propulsion auxiliary systems

Propulsion auxiliary systems include all the systems that are necessary for the normal operation of a propulsion system. It includes or may include:

- the fuel oil supply system from and including the service tanks (see Note 1)
- the lubricating oil systems serving the engines, the gear-box, the shaftline bearings, the stern tube, etc. (see Note 2)
- the hydraulic oil systems for operating clutches, controllable pitch propellers, waterjet reverse deflectors, starting systems, etc.
- the fresh water cooling systems serving any component of the propulsion system or used for cooling the fuel oil circuits, the lubricating oil circuits, the hydraulic oil circuits, etc.
- the sea water cooling systems used for cooling any component of the propulsion system or any of the aforementioned systems
- the heating systems (using electricity, steam or thermal fluids)
- the starting systems (air, electrical, hydraulic)
- the power supply (air, electrical, hydraulic)
- the control, monitoring and safety systems
- the ventilation installation where necessary (e.g. to supply combustion air or cooling air to the primer movers).

Note 1: The fuel oil filling, transfer and purifying systems are not included.

Note 2: The lubricating oil filling, transfer and purifying systems are not included.

##### 1.2.4 Safety systems

Safety systems include all the systems that are necessary for the safety of the ship operation. They include:

- fire fighting systems
- bilge system
- communication systems
- navigation lights
- life-saving appliances
- machinery safety systems which prevent of any situation leading to fire or catastrophic damage.

##### 1.2.5 Active components

Active component means any component of the main propulsion and auxiliary propulsion system that transmits or transfers energy by mechanical, thermal or chemical means such as fans, pumps, heat exchangers or compressors, including their monitoring and control systems.

Pipes, manually controlled valves and tanks are not to be considered as active components.

Electric cables are to be considered as active components.

**1.2.6 System failure**

A system failure means any failure of an active component which is necessary for the operation of a propulsion system or power generation plant, including their auxiliary systems.

Only a single failure of the systems defined in [1.2.1] to [1.2.4] needs to be considered.

**1.2.7 Essential components**

Essential components include pumps, heat exchangers, valve actuators, and electrical type approved components, as required in Pt C, Ch 2, Sec 15, [2.1.1].

**1.3 Documentation to be submitted**

**1.3.1** The documents listed in Tab 1 are to be submitted.

**2 General design requirements**

**2.1 Principle**

**2.1.1** Ships having the additional class notation **AVM-APS** are to be fitted with:

- at least one main propulsion systems as defined in [1.2.1]
- at least one alternative propulsion system, as defined in [1.2.2], so designed and arranged that, in case of any failure as defined in [1.2.6] affecting the main propulsion system or its auxiliary services, there remain sufficient propulsion to operate the ship in safe conditions, as defined in [2.2.1]
- an electrical power plant so designed that in case of any failure, as defined in [1.2.6] in the plant, there remains enough electrical power to maintain simultaneously:
  - sufficient propulsion and steering capability to operate the ship in safe conditions, as defined in [2.2.1]
  - the availability of safety systems.

**2.1.2** Compliance with requirements [2.1.1]above is to be demonstrated by a risk analysis.

**2.2 Alternative propulsion machinery**

**2.2.1** The alternative propulsion machinery is to be so arranged that, in case the main propulsion system becomes inoperative, the propulsion power of the ship remains available or can be recovered, allowing the ship to proceed at a speed of not less than 7 knots assuming that:

- the ship is fully laden
- normal weather conditions: BF 5.

**2.2.2** The auxiliary systems serving the main propulsion and the alternative propulsion systems may have common components, be arranged for possible interconnection or serve other systems on board the ship provided that in case of any single failure affecting those systems, not more than one of the main or auxiliary propulsion systems is disabled. This is to be substantiated by the risk analysis.

**3 Special arrangements**

**3.1 Propulsion system**

**3.1.1 Change-over from main propulsion to auxiliary propulsion**

The alternative propulsion system is to be capable of being brought into operation within 30 mn after the loss of the main propulsion system.

Means are to be provided to protect the crew from any risk of injury during the change-over procedure from main propulsion to auxiliary propulsion.

Where necessary, arrangements are to be made to:

- prevent any inadvertent starting of the engine
- maintain the shafting in locked position.

**Table 1 : Documents to be submitted**

No.	I/A (1)	Document
1	I	Electrical load balance, including alternative propulsion system conditions
2	I	Machinery spaces general arrangement of the alternative propulsion system
3	A	Diagrams of fuel oil system, cooling system, lubricating system, starting air system
4	A	Description of the alternative propulsion system and interface with main propulsion system
5	A	Torsional vibration calculation in alternative propulsion mode
6	A	A risk analysis demonstrating the availability of the operating conditions as per [2.2.1] in case of a single failure as per [1.2.6] (2)
7	I	An operating manual with the description of the operations necessary to recover the propulsion and essential services in case of a single failure as described in [1.2.6]

(1) A : to be submitted for approval;  
I : to be submitted for information

(2) This analysis may be in the form of a Failure Mode and Effect Analysis (FMEA), unless the actual arrangement of the machinery and equipment is quite simple and sufficient operating experience can be demonstrated such as to make unlikely the possibility of consequence failure in the case of a single failure. In such a case the Society may consider to accept a functional description of system in lieu of the requested analysis.



### 3.1.2 Automation

- a) The alternative propulsion system is to be integrated with any automation system installed on board.
- b) In case the alternative propulsion system is electrical, the automation system of electrical motor is to be suitable for the electrical propulsion plant.

## 3.2 Systems for cooling, lubrication, fuel supply, air starting, monitoring and control

### 3.2.1 Cooling system

The circuit for the main engine may be used provided that it can be operated with the part relative to the main engine itself being cut off.

### 3.2.2 Lubrication system

The lubrication oil system of the alternative propulsion system is to be independent of the main engine one.

Where the a gear box is used for both main and auxiliary propulsions, its lubricating oil system is to be independent of the main engine one.

### 3.2.3 Fuel oil system

The circuit for the main engine may be used provided that:

- a) Proper operation is ensured with the part relative to the main engine itself being cut off
- b) The alternative propulsion system is to be supplied from a least two service tanks and two storage tanks. Means and procedures are to be provided to periodically equalize the content on each storage tank and on each service tank during the consumption of the fuel.

### 3.2.4 Air starting system

If applicable, the circuit for the main engine may be used provided that proper operation is ensured with the part relative to the main engine itself being cut off.

### 3.2.5 Monitoring and control system

Monitoring and control systems of alternative propulsion system are to be independent of that for the main engine (see also [3.1.2]).

## 3.3 Electrical installations

**3.3.1** Single failure leading to the loss of more than one generating set at one time may be accepted, provided the FMEA demonstrates that, after the failure, enough power still remains available to operate the ship under the conditions stated in [2.2.1] without any stand-by generating set still available.

**3.3.2** The electrical power available is to be sufficient to withstand starting of the heaviest consumer without impairing the electrical distribution balance. Arrangement are to be made to avoid any untimely overload.

The recourse to the capacity of emergency source is not to be considered.

**3.3.3** Electrical stand-by pumps may not be considered in the electrical load balance during alternative propulsion mode operation.

**3.3.4** Main switchboard is to be automatically separable in two sections.

Where a failure occurs on one section of the main switchboard, the remaining section is to be able to supply the services indicated in [1.2.1].

## 4 Tests on board

### 4.1 Operational tests

**4.1.1** The alternative propulsion system is to be subjected to the operational tests required by the Rules for similar systems.

### 4.2 Sea trials

**4.2.1** The alternative propulsion system is to undergo the following tests during the sea trials:

- Test required by the risk analysis conclusions and, where deemed necessary, simulation of certain single failures.
- The values of the power and speed developed by the alternative propulsion system are to be recorded, as well as the electrical consumption.
- An activation test to demonstrate the propulsion mode changeover and corresponding time to operate as indicated in [3.1.1].

## SECTION 2

## DUPLICATED PROPULSION SYSTEM (AVM-DPS)

### 1 General

#### 1.1 Application

**1.1.1** The additional class notation **AVM-DPS** is assigned in accordance with Pt A, Ch 1, Sec 2, [6.3.3] to ships arranged with redundant propulsion and steering installations complying with the requirements of this Section.

**1.1.2** Machinery, electrical installation and automation are to comply with the relevant provisions of Part C.

**1.1.3** The additional suffix **NS** may be added to the additional class notation **AVM-DPS** when the ship is intended for normal operation with one propulsion system out of service and designed in accordance with the provisions of [4]. The availability of electric production is not covered by this additional suffix.

#### 1.2 Definitions

##### 1.2.1 Propulsion system

A propulsion system is a system that provides thrust to the ship. It includes:

- the prime mover, including the integral equipment, driven pumps, etc.
- the equipment intended to transmit the torque
- the propulsion electric motor, where applicable
- the equipment intended to convert the torque into thrust
- the auxiliary systems necessary for operation
- the control, monitoring and safety systems.

##### 1.2.2 Steering system

A steering system is a system that controls the heading of the ship. It includes

- the power actuating system
- the equipment intended to transmit the torque to the steering device
- the steering device (e.g. rudder, rotatable thruster, waterjet steering deflector, etc.).

##### 1.2.3 Propulsion auxiliary systems

Propulsion auxiliary systems include all the systems that are necessary for the normal operation of a propulsion system. It includes or may include:

- the fuel oil supply system from and including the service tanks

Note 1: The fuel oil filling, transfer and purifying systems are not included.

- the lubricating oil systems serving the engines, the gearbox, the shaftline bearings, the stern tube, etc.

Note 2: The lubricating oil filling, transfer and purifying systems are not included.

- the hydraulic oil systems for operating clutches, controllable pitch propellers, waterjet reverse deflectors, starting systems, etc.
- the fresh water cooling systems serving any component of the propulsion system or used for cooling the fuel oil circuits, the lubricating oil circuits, the hydraulic oil circuits, etc.
- the sea water cooling systems used for cooling any component of the propulsion system or any of the aforementioned systems,
- the heating systems (using electricity, steam or thermal fluids)
- the starting systems (air, electrical, hydraulic)
- the power supply (air, electrical, hydraulic)
- the control, monitoring and safety systems
- the ventilation installation where necessary (e.g. to supply combustion air or cooling air to the primer movers).

##### 1.2.4 Steering auxiliary systems

Steering auxiliary systems include all the systems that are necessary for the normal operation of a steering system. It includes or may include:

- the fresh water cooling systems
- the sea water cooling systems
- the power supply (air, electrical, hydraulic)
- the control, monitoring and safety systems.

##### 1.2.5 Safety systems

Safety systems include all the systems that are necessary for the safety of the ship operation. They include:

- fire fighting systems
- bilge system
- communication systems
- navigation lights
- life-saving appliances
- machinery safety systems which prevent of any situation leading to fire or catastrophic damage

##### 1.2.6 System failure

A system failure means any failure of any component of a propulsion system, steering system or power generation plant, including their auxiliary and control systems.

Components such as pipes or electric cables are also to be considered.

Only single failure needs to be considered.

##### 1.2.7 Essential components

Essential components include pumps, heat exchangers, valve actuators, and electrical type approved components, as required in Pt C, Ch 2, Sec 15, [2.1.1].

Table 1 : Documents to be submitted

No.	I/A (1)	Document
1	I	Electrical load balance, including one of the propulsion system out of service
2	I	Machinery spaces general arrangement of duplicated propulsion system steering systems and main electrical components
3	A	Diagram of fuel oil system, lubricating system, hydraulic oil systems, sea water and fresh cooling systems, heating systems, starting air system, control air system, steering system
4	A	Single line diagrams of main electrical distribution system
5	A	Description of the duplicated propulsion system
6	A	A risk analysis demonstrating the availability of the operating conditions as per [2.2.1] in case of a single failure as per Ch 2, Sec 1, [1.2.6] (2)
7	I	An operating manual with the description of the operations necessary to recover the propulsion, steering and safety systems in case of a single failure (see [2.1.1])
<p>(1) A : to be submitted for approval I : to be submitted for information</p> <p>(2) The risk analysis may be in the form of a Failure Mode and Effect Analysis (FMEA). Ch 2, App 1 describes an acceptable procedure for carrying out the FMEA.</p>		

### 1.3 Documents to be submitted

1.3.1 The documents listed in Tab 1 are to be submitted.

## 2 General design requirements

### 2.1 Principle

2.1.1 Ships having the additional class notation **AVM-DPS** are to be fitted with:

- at least two propulsion systems and two steering systems so designed and arranged that, in case of any failure as defined in [1.2.6] affecting such systems or their auxiliary services, there remains sufficient propulsion and steering capabilities to operate the ship in safe conditions, as defined in [2.2.1]
- an electrical power plant so designed that in case of any failure as defined in [1.2.6] in the plant, there remains enough electrical power to maintain simultaneously:
  - sufficient propulsion and steering capability to operate the ship in safe conditions, as defined in [2.2.1]
  - the availability of safety systems.

2.1.2 The loss of one compartment due to fire or flooding is not to be considered as a failure. Accordingly, the propulsion systems and/or their auxiliary systems or components thereof may be installed in the same compartment. This also applies to the steering systems and the electrical power plant.

2.1.3 Compliance with requirements [2.1.1] above is to be demonstrated by a risk analysis.

### 2.2 Propulsion machinery

2.2.1 The propulsion machinery is to consist of at least two mechanically independent propulsion systems so arranged

that, in case one propulsion system becomes inoperative, at least 50% of the propulsion power of the ship remains available and allows the ship to proceed at a speed of not less than 7 knots assuming that:

- the ship is fully laden
- normal weather conditions: BF 5

Note 1: Propulsion power means the total maximum continuous rated output power in kilowatts of all the ship's main propulsion machinery which appears on the ship's certificate of registry or other official document.

2.2.2 The auxiliary systems serving the propulsion systems may have common components, be arranged for possible interconnection or serve other systems on board the ship provided that in case of any single failure affecting those systems, not more than one propulsion system is disabled. This is to be substantiated by the risk analysis.

2.2.3 Where a propulsion system becomes inoperative due to a failure as indicated in [2.2.2] above, the following conditions are to be satisfied:

- other propulsion systems that were in operation before the failure are not to be affected by the failure. In particular there should be no significant modification of the power or rotational speed of the concerned prime mover
- other propulsion systems that were not in operation before the failure are to be maintained available (heating and prelubrication) so as to allow restarting of a propulsion system within 45 seconds after the failure.

Note 1: The blackout recovery time is excluded, however restarting time for propulsion system in case of blackout is not to exceed 120 seconds.

- safety precautions for the failed propulsion system are to be taken, such as shaft blocking.

This is to be demonstrated during the sea trials.

## 2.3 Steering machinery

**2.3.1** The steering machinery is to consist of at least two independent steering systems, each one complying with the following provisions:

- Pt C, Ch 1, Sec 11, [2] in the case of a standard arrangement with rudder and steering gear, and in particular the requirement of Pt C, Ch 1, Sec 11, [2.2.1] relating to the performance of the steering gear
- Pt C, Ch 1, Sec 11, [4] in the case of rotatable thrusters.

Note 1: Other types of combined propulsion and steering systems (such as waterjets or cycloidal propellers) will be given special consideration.

**2.3.2** The steering systems are to be so designed and arranged that in case of any failure, as defined in Ch 2, Sec 2, in the systems or in the associated auxiliary systems (cooling systems, electrical power supply, control system, etc.) not more than one steering system is disabled, thus allowing the steering capability to be continuously maintained. This is to be substantiated by the risk analysis.

## 3 Specific design requirements

### 3.1 Propulsion machinery

#### 3.1.1 Oil fuel storage and transfer systems

At least two storage tanks for each type of fuel used by the propulsion engines and the generating sets are to be provided. Means and procedures are to be provided to periodically equalize the content on each storage tank and on each service tank during the consumption of the fuel.

#### 3.1.2 Oil fuel supply lines

Oil fuel supply from the service tank to the propulsion machinery and to the electrical power plant is to be ensured by two separate lines.

### 3.2 Steering systems

#### 3.2.1 Synchronising system

The steering capability of the ship is to be maintained in case of failure of the synchronising system required by the Rules, Pt C, Ch 1, Sec 11, [3.2], without stopping.

### 3.3 Electrical installations

**3.3.1** Single failure leading to the loss of more than one generating set at one time may be accepted, provided the FMEA demonstrates that, after the failure, enough power still remains available to operate the ship under the conditions stated in [2.2.1] without any stand-by generating set still available.

The recourse to the capacity of emergency source is not to be considered.

**3.3.2** The main switchboard is to be automatically separable in two sections. The switchboard is to be arranged with all circuits properly distributed between these sections.

Where a failure occurs on one section of the main switchboard, the remaining section is to be able to supply the services defined in [1.2.1] to [1.2.5].

### 3.4 Automation

**3.4.1** The automation system is to be arranged in such a way that a single failure of the control system may lead to the loss of one propulsion system only.

## 4 Additional requirements for ships having the notation AVM-DPS/NS

### 4.1 Propulsion machinery

**4.1.1** Each propulsion system fitted to ships having the notation **AVM-DPS/NS** is to be so designed that in case of failure of an essential component affecting the following systems:

- fuel oil supply system
- lubricating oil system
- sea water and fresh water cooling systems
- starting air system
- control air system
- control, monitoring and safety systems
- ventilation of machinery spaces

the operation of the propulsion system can be sustained or speedily restored without any power limitation.

### 4.2 Electrical installations

**4.2.1** Electrical stand-by pumps are to be considered in the electrical load balance when **NS** notation suffix is granted.

## 5 Tests on board

### 5.1 Operating tests

**5.1.1** The propulsion systems, steering system as well as the power generation plant are to be subjected to the tests required by the Rules.

### 5.2 Sea trials

**5.2.1** The propulsion machinery, steering machinery and the power generation plant are to undergo the following tests during the sea trials:

- tests required by the risk analysis conclusions and, where deemed necessary, simulation of certain single failures
- the values of the power and speed developed by the propulsion prime movers under test are to be recorded, as well as the electrical consumption.
- Tests with one propulsion system out of service, in order to verify the requirement [2.2.3].

Note 1: The speed is to be recorder with one propulsion system out of service, in order to verify the speed criteria required in [2.2.1].

## SECTION 3

## INDEPENDENT PROPULSION SYSTEMS (AVM-IPS)

### 1 General

#### 1.1 Application

**1.1.1** The additional class notation **AVM-IPS** is assigned in accordance with Pt A, Ch 1, Sec 2, [6.3.4] to ships arranged with independent propulsion and steering installations complying with the requirements of this Section.

**1.1.2** Machinery, electrical installation and automation are to comply with the relevant provisions of Part C.

**1.1.3** The additional suffix **NS** may be added to the additional class notation **AVM-IPS** when the ship is intended for normal operation with one propulsion system out of service and designed in accordance with the provisions of Ch 2, Sec 2, [4]. The availability of electric production is not covered by this additional suffix.

#### 1.2 Definitions

##### 1.2.1 Propulsion system

A propulsion system is a system that provides thrust to the ship. It includes:

- the prime mover, including the integral equipment, driven pumps, etc.
- the equipment intended to transmit the torque
- the propulsion electric motor, where applicable
- the equipment intended to convert the torque into thrust
- the auxiliary systems necessary for operation
- the control, monitoring and safety systems.

##### 1.2.2 Steering system

A steering system is a system that controls the heading of the ship. It includes

- the power actuating system
- the equipment intended to transmit the torque to the steering device
- the steering device (e.g. rudder, rotatable thruster, waterjet steering deflector, etc.).

##### 1.2.3 Propulsion auxiliary systems

Propulsion auxiliary systems include all the systems that are necessary for the normal operation of a propulsion system. It includes or may include:

- the fuel oil supply system from and including the service tanks, and the parts of the filling, transfer and purifying systems located in machinery spaces
- the lubricating oil systems serving the engines, the gearbox, the shaftline bearings, the stern tube, etc., and the parts of the lubricating oil filling, transfer and purifying systems located in machinery spaces

- the hydraulic oil systems for operating clutches, controllable pitch propellers, waterjet reverse deflectors, starting systems, etc.
- the fresh water cooling systems serving any component of the propulsion system or used for cooling the fuel oil circuits, the lubricating oil circuits, the hydraulic oil circuits, etc
- the sea water cooling systems used for cooling any component of the propulsion system or any of the aforementioned systems
- the heating systems (using electricity, steam or thermal fluids)
- the starting systems (air, electrical, hydraulic)
- the control air systems
- the power supply (air, electrical, hydraulic)
- the control, monitoring and safety systems
- the ventilation installation where necessary (e.g. to supply combustion air or cooling air to the primer movers).

##### 1.2.4 Steering auxiliary systems

Steering auxiliary systems include all the systems that are necessary for the normal operation of a steering system. It includes or may include:

- the fresh water cooling systems
- the sea water cooling systems
- the control air systems
- the power supply (air, electrical, hydraulic)
- the control, monitoring and safety systems.

##### 1.2.5 Safety systems

Safety systems include all the systems that are necessary for the safety of the ship operation. They include:

- fire fighting systems
- bilge system
- communication systems
- navigation lights
- life-saving appliances
- machinery safety systems which prevent of any situation leading to fire or catastrophic damage.

##### 1.2.6 System failure

A system failure means any failure of any component of a propulsion system, steering system or power generation plant, including their auxiliary and control systems.

Components such as pipes or electric cables are also to be considered.

Only single failure needs to be considered.

##### 1.2.7 Fire and flooding casualty

Fire and flooding casualties are to be considered only in machinery spaces and limited to a single space.

**1.2.8 Essential components**

Essential components include pumps, heat exchangers, valve actuators, and electrical type approved components, as required in Pt C, Ch 2, Sec 15, [2.1.1].

**1.2.9 Separate compartments**

Separate compartments mean compartments which are separated by a fire and watertight bulkhead.

**1.3 Documents to be submitted**

**1.3.1** The documents listed in Tab 1 are to be submitted.

**2 General design requirements**

**2.1 Principle**

**2.1.1** Ships having the additional class notation **AVM-IPS** are to comply with the provisions relevant to notation **AVM-DPS**, as mentioned in Ch 2, Sec 2, [2.1.1].

**2.1.2** In addition, in the event of fire or flooding casualty in the machinery spaces, the propulsion, steering and power generation capabilities are to remain sufficient to operate the ship in safe conditions defined in [2.3.2].

**2.1.3** Where a propulsion system becomes inoperative due to a fire or flooding casualty, other propulsion systems are not to be affected by the casualty.

**2.1.4** Compliance with requirements [2.1] and [2.1.2] above is to be demonstrated by a risk analysis.

**2.2 Compartment arrangement**

**2.2.1** Separation bulkhead between machinery compartments is to be A60.

**2.2.2** The separation bulkhead between two compartments are to be designed so as to withstand the maximum water level expected after flooding.

**2.2.3** The machinery control room is to be separated from all machinery spaces by A60 bulkhead.

**2.2.4** The main switchboard is not to be located in the control room

**2.3 Propulsion machinery**

**2.3.1** The propulsion machinery is to consist of at least two mechanically independent propulsion systems located in separate compartments and so arranged that, in case one propulsion system becomes inoperative due to a system failure, at least 50% of the propulsion power of the ship remains available and allows the ship to proceed at a speed of not less than 7 knots assuming that:

- the ship is fully laden,
- normal weather conditions: BF 5

Note 1: Propulsion power means the total maximum continuous rated output power in kilowatts of all the ship's main propulsion machinery which appears on the ship's certificate of registry or other official document

**2.3.2** In case of a fire or a flooding casualty, sufficient propulsion power is to remain available to allow the ship to proceed at speed of not less than 7 knots assuming that:

- the ship is fully laden,
- normal weather conditions: BF 5

**Table 1 : Documents to be submitted**

No.	I/A (1)	Document
1	I	Electrical load balance, including one of the propulsion system out of service
2	I	Machinery spaces general arrangement of independent propulsion system, steering systems and main electrical components
3	A	Diagram of fuel oil system, lubricating system, hydraulic oil systems, sea water and fresh cooling systems, heating systems, starting air system, control air system, steering system
4	A	Single line diagrams of main electrical distribution system
5	A	Description of the independent propulsion system
6	A	A risk analysis demonstrating the availability of the concerned systems in case of a single failure (see [2.1.4] [2.3.3] and [2.4.2]) (2)
7	I	An operating manual with the description of the operations necessary to recover the propulsion, steering and safety systems in case of a single failure (see [2.1])
8	A	Bulkhead arrangement of separate machinery spaces
<p>(1) A : to be submitted for approval, I : to be submitted for information, (2) The risk analysis may be in the form of a Failure Mode and Effect Analysis (FMEA). Ch 2, App 1 describes an acceptable procedure for carrying out the FMEA.</p>		

**2.3.3** The auxiliary systems serving the propulsion systems may have common components, be arranged for possible interconnection or serve other systems on board the ship provided that in case of any single failure or fire or flooding casualty affecting those systems, not more than one propulsion system is disabled. This is to be substantiated by the risk analysis.

Note 1: The risk analysis is to consider that any space containing a component of a propulsion system or auxiliary system thereof, as defined in requirements [1.2.1] and [1.2.3] may be affected by a fire or flooding casualty.

**2.3.4** Where a propulsion system becomes inoperative due to a system failure, the following conditions are to be satisfied:

- other propulsion systems that were in operation before the failure are not to be affected by the failure. In particular there should be no significant modification of the power or rotational speed of the concerned prime mover
- other propulsion systems that were not in operation before the failure are to be maintained available (heating and prelubrication) so as to allow restarting of propulsion system within 45 seconds after the failure
- safety precaution for the failed propulsion system are to be taken, such as shaft blocking.

This is to be demonstrated during the sea trials.

## 2.4 Steering machinery

**2.4.1** The steering machinery is to consist of at least two independent steering systems located in separate compartments, each one complying with the following provisions of Pt C, Ch 1, Sec 11:

- Pt C, Ch 1, Sec 11, [3] in the case of a standard arrangement with rudder and steering gear, and in particular Pt C, Ch 1, Sec 11, [2.2.1] thereof relating to the performance of the steering gear
- Pt C, Ch 1, Sec 11, [4] in the case of rotatable thrusters.

Note 1: Other types of combined propulsion and steering systems (such as waterjets or cycloidal propellers) will be given special consideration.

**2.4.2** The steering systems are to be so designed and arranged that in case of:

- any single failure in a steering system or in the associated auxiliary systems as defined in [1.2.2] and [1.2.4]
- or fire or flooding casualty affecting one of concerned space

not more than one steering system is disabled, thus allowing the steering capability to be maintained. This is to be substantiated by the risk analysis.

## 2.5 Electrical power plant

**2.5.1** Electrical power plant, including main distribution system is to be arranged in separate compartments, so that in case of fire or flooding casualty, the electrical power necessary to supply the systems defined in [1.2.1] to [1.2.5] remain available.

## 3 Specific design requirements

### 3.1 Propulsion machinery

#### 3.1.1 Oil fuel storage and transfer systems

At least two storage tanks for each type of fuel used by the propulsion machinery and the electrical power plant are to be provided. Means and procedures are to be provided to periodically equalize the content on each storage tank during the consumption of the fuel.

#### 3.1.2 Oil fuel service tanks and supply lines

Oil fuel service tanks are to be located in separate spaces and means and procedures are to be provided to periodically equalize their content during the consumption of the fuel.

Oil fuel supply from each service tank to the propulsion machinery and to the electrical power plant is to be ensured by two separate lines.

#### 3.1.3 Oil fuel units

Oil fuel units serving the propulsion machinery and the electric power plant are to be distributed in two separate spaces so that in case of fire in one of those spaces, the availability criteria set out in [2.1.2] are satisfied.

#### 3.1.4 Oil fuel purifying system

Where provided, oil fuel purifiers are to be distributed in two separate spaces.

#### 3.1.5 Ventilation system

The ventilation system is to be so designed and arranged that in case of fire in one machinery space accompanied with ventilation stopping, the ventilation is to remain operative in other spaces, so that the availability criteria set out in [2.1.2] are satisfied.

### 3.2 Steering systems

#### 3.2.1 Synchronising system

The steering capability of the ship is to be maintained in case of failure of the synchronising system required by the Rules, Pt C, Ch 1, Sec 11, [3.2], without stopping.

### 3.3 Electrical installations

**3.3.1** Single failure and fire and flooding casualties leading to the loss of more than one generating set at one time may be accepted, provided the FMEA demonstrates that, after the failure, enough power still remains available to operate the ship under the conditions stated in [2.3.1] and [2.3.2] without any stand-by generating set still available.

The recourse to the capacity of emergency source is not to be considered.

**3.3.2** The main switchboard is to be automatically separable in two sections distributed in independent spaces separated by watertight and A60 fire resistant bulkheads. The switchboard is to be arranged with all circuits properly distributed between these sections.

Where a failure occurs on one section of the main switch-board, the remaining section is to be able to supply the services indicated in [1.2.1] to [1.2.5].

### 3.4 Automation

**3.4.1** The automation system is to be arranged in such a way that a single failure of the control system, including fire and flooding casualty, may lead to the loss of one propulsion system only.

**3.4.2** Control stations of propulsion and steering system are to be arranged so as in case of fire or flooding casualty, the control is still available.

## 4 Additional requirements for ships having the notation AVM-IPS/NS

### 4.1 Propulsion machinery

**4.1.1** Each propulsion system fitted to ships having the notation **AVM-IPS/NS** is to be so designed that in case of failure of an essential component affecting the following systems:

- fuel oil supply system
- lubricating oil system
- sea water and fresh water cooling systems
- starting air system
- control air system
- control, monitoring and safety systems

the operation of the propulsion system can be sustained or speedily restored without any power limitation.

### 4.2 Electrical installations

**4.2.1** Electrical stand-by pumps are to be considered in the electrical load balance when **NS** notation suffix is granted.

## 5 Tests on board

### 5.1 Operating tests

**5.1.1** Each propulsion systems, steering system as well as the power generation plant are to be subjected to the tests required by the Rules.

### 5.2 Sea trials

**5.2.1** The propulsion machinery, steering machinery and the power generation plant are to undergo the following tests during the sea trials:

- tests required by the risk analysis conclusions and, where deemed necessary, simulation of certain single failures
- the values of the power and speed developed by the propulsion prime movers under test are to be recorded, as well as the electrical consumption
- Tests with one propulsion system out of service, in order to verify the requirement [2.3.1].

Note 1: The speed is to be recorder with one propulsion system out of service, in order to verify the speed criteria required in [2.3.1].



## SECTION 4

# FIRE MITIGATION FOR MAIN DIESEL-GENERATOR ROOMS (AVM-FIRE)

## 1 General

### 1.1 Application

**1.1.1** The additional class notation **AVM-FIRE** is assigned in accordance with Pt A, Ch 1, Sec 2, [6.3.5] to self-propelled ships arranged with means complying with the requirements of this Section for maintaining a minimum of propulsion, steering, and habitability in case of fire.

**1.1.2** Installation of machinery, electrical systems and automation is to comply with relevant provisions of Part C.

**1.1.3** The additional class notation **AVM-FIRE** is assigned alone or in addition to the additional class notation **AVM-APS** or **AVM-DPS**.

### 1.2 Definitions

#### 1.2.1 Propulsion system

A propulsion system is a system that provides thrust to the ship. It includes:

- prime mover, including the integral equipment, driven pumps, etc
- equipment intended to transmit the torque
- propulsion electric motor, where applicable
- equipment intended to convert the torque into thrust
- auxiliary systems necessary for operation
- control, monitoring and safety systems.

#### 1.2.2 Steering system

A steering system is a system that controls the heading of the ship. It includes:

- power actuating system
- equipment intended to transmit the torque to the steering device
- steering device (e.g. rudder, rotatable thruster, waterjet steering deflector, etc.).

#### 1.2.3 Propulsion auxiliary systems

Propulsion auxiliary systems include all the systems that are necessary for the normal operation of a propulsion system. Propulsion auxiliary systems include or may include:

- fuel oil supply system from, and including, the service tanks, and the parts of the filling, transfer and purifying systems located in machinery spaces

- lubricating oil systems serving the engines, the gearbox, the shaftline bearings, the stern tube, etc., and the parts of the lubricating oil filling, transfer and purifying systems located in machinery spaces
- hydraulic oil systems for operating clutches, controllable pitch propellers, waterjet reverse deflectors, starting systems, etc
- fresh water cooling systems serving any component of the propulsion system or used for cooling the fuel oil circuits, the lubricating oil circuits, the hydraulic oil circuits, etc
- sea water cooling systems used for cooling any component of the propulsion system or any of the aforementioned systems
- heating systems (using electricity, steam or thermal fluids)
- starting systems (air, electrical, hydraulic)
- control air systems
- power supply (air, electrical, hydraulic)
- control, monitoring and safety systems
- ventilation installation where necessary (e.g. to supply combustion air or cooling air to the primer movers).

#### 1.2.4 Steering auxiliary systems

Steering auxiliary systems include all the systems that are necessary for the normal operation of a steering system. Steering auxiliary systems include or may include:

- fresh water cooling systems
- sea water cooling systems
- control air systems
- power supply (air, electrical, hydraulic)
- control, monitoring and safety systems.

#### 1.2.5 Safety systems

Safety systems include all the systems that are necessary for the safety of the ship operation:

- fire fighting systems
- bilge system
- communication systems
- navigation lights
- life-saving appliances
- machinery safety systems which prevent any situation leading to fire or catastrophic damage.

**Table 1 : Documents to be submitted**

No.	I/A (1)	Document
1	I	Electrical load balance, including main diesel-generator room out of service
2	I	Machinery spaces general arrangement of main diesel-generator room, with main electrical components and cable routing
3	A	Single line diagrams of main electrical distribution system
4	A	A risk analysis demonstrating the availability of the concerned systems in case of fire in a main diesel-generator room (see [2.1]) (2)
5	I	An operating manual with the description of the operations necessary to recover the propulsion, steering and safety systems in case of fire in main diesel-generator room (see[2.1])
6	A	Structural fire protection arrangement of main diesel-generator rooms
<p>(1) A : To be submitted for approval I : To be submitted for information.</p> <p>(2) The risk analysis may be in the form of a failure Mode and Effect analysis (FMEA). Ch 2, App 1 describes an acceptable procedure for carrying out the FMEA.</p>		

### 1.2.6 Habitability services

Services considered necessary for crew and passenger areas habitability include:

- sanitary water
- toilets
- ventilation
- HVAC
- galley facility
- provision rooms systems
- lighting.

### 1.2.7 Fire casualty

Fire casualty is to be considered only in one main diesel-generator room and limited to this single space.

## 1.3 Documents to be submitted

1.3.1 The documents listed in Tab 1 are to be submitted.

## 2 General design requirements

### 2.1 Principle

2.1.1 Machinery is to be so designed and arranged that, in case of any fire casualty occurring in one main diesel-generator room as defined in [1.2.7], sufficient operating functionality for propulsion, steering is still available as required in [2.3] and a minimum of 50% of the habitability services as defined in [1.2.6] remain operative.

2.1.2 Control stations of propulsion and steering system are to be arranged so as, in case of fire casualty occurring in one main diesel-generator rooms, the control of remaining propulsion and steering systems is still available.

2.1.3 Manual intervention may be accepted in order to make the systems available as required in [2.1.1] in the minimum possible time. In general, feasibility of manual actions should be demonstrated by tests or drills.

2.1.4 Compliance with requirements [2.1.1] and [2.1.2] is to be demonstrated by a risk analysis.

### 2.2 Electrical power plant

2.2.1 Main diesel-generators are to be distributed between at least two engine rooms.

2.2.2 Main diesel-generators and the main distribution system are to be arranged so that, in case of fire in one main diesel-generator room, the electrical power necessary to supply the systems defined in [1.2.1] to [1.2.6] remains available, in accordance with the principles detailed in [2.1].

2.2.3 Single failure and fire casualties in one main diesel-generator room leading to the loss of more than one generating set at one time may be accepted, provided that, after the failure, enough power still remains available to operate the ship under the conditions stated in [2.3.1] and [2.3.2] without any stand-by generating set still available. The recourse to the capacity of emergency source is not to be considered.

### 2.3 Propulsion and steering

2.3.1 In case of a fire casualty as defined in [1.2.7], sufficient propulsion power is to remain available to allow the ship to proceed at speed of not less than 7 knots, assuming:

- the ship is fully loaded
- normal weather conditions: BF 5.

2.3.2 The steering systems are to be so designed and arranged that, in case of fire casualty as defined in [1.2.7], not more than one steering system is disabled, thus allowing the steering capability to be continuously maintained.

### 2.4 Fire protection and detection

2.4.1 Each main diesel-generator room shall be surrounded by A60 bulkheads and overhead deck.

2.4.2 The fire detection might be lost only in the main diesel-generator room affected by the fire casualty and shall remain operational in all other spaces.

### 3 Tests on board

#### 3.1 Operating tests

**3.1.1** Each propulsion system, steering system as well as the power generation plant are to be subjected to the tests required by the Rules.

#### 3.2 Sea trials

**3.2.1** The propulsion machinery, steering machinery and the power generation plant are to undergo the following tests during the sea trials:

- tests required by the risk analysis conclusions and, where deemed necessary, simulation of certain single failures as well as certain manual actions as defined in [2.1.3]
- the values of the power and speed developed by the propulsion prime movers under test are to be recorded, as well as the electrical consumption.

Note 1: The speed is to be recorded with one propulsion system out of service, in order to verify the speed criteria required in [2.3.1].

# APPENDIX 1

# PROCEDURES FOR FAILURE MODES AND EFFECT ANALYSIS

## 1 General

### 1.1 Introduction

#### 1.1.1 FMEA requirement

As specified in Ch 2, Sec 1, Ch 2, Sec 2 and Ch 2, Sec 3 in order to grant the **AVM** notations, an FMEA is to be carried out, with the exception indicated in Note (2) of Ch 2, Sec 1, Tab 1 in case of single failure to the propulsion, steering and power generating system, the ship is still capable to achieve the performances indicated in the applicable Sections as a condition for granting the notation.

#### 1.1.2 Scope of the Appendix

This Appendix describes a failure mode and effects analysis (FMEA) and gives guidance as to how it may be applied by:

- explaining basic principles
- providing the procedural steps necessary to perform an analysis
- identifying appropriate terms, assumptions, measures and failure modes, and
- providing examples of the necessary worksheets.

#### 1.1.3 Definition of FMEA

A practical, realistic and documented assessment of the failure characteristics of the ship and its component systems should be undertaken with the aim of defining and studying the important failure conditions that may exist.

#### 1.1.4 FMEA principles

The FMEA is based on a single failure concept under which each considered system at various levels of a system's functional hierarchy is assumed to fail by one probable cause at a time. The effects of the postulated failure are analysed and classified according to their severity. Such effects may include secondary failures (or multiple failures) at other level(s). Any failure mode which may cause a catastrophic effect should be guarded against by system or equipment redundancy unless the probability of such failure is extremely improbable. For failure modes causing hazardous effects corrective measures may be accepted in lieu. A test programme should be drawn up to confirm the conclusions of FMEA.

#### 1.1.5 Alternatives

While FMEA is suggested as one of the most flexible analysis techniques, it is accepted that there are other methods which may be used and which in certain circumstances may offer an equally comprehensive insight into particular failure characteristics.

### 1.2 Objectives

#### 1.2.1 Primary objective

The primary objective of FMEA is to provide a comprehensive, systematic and documented investigation which establishes the important failure conditions of the ship propulsion, steering and power generation systems, as well as any other system requested by the Owner, and assesses their significance with regard to the safety of the ship and its occupants.

#### 1.2.2 Aim of the analysis

The main aims of undertaking the analysis are to:

- provide ship and system designers with data to audit their proposed designs
- provide the Owner with the results of a study into ship's selected systems failure characteristics so as to assist in an assessment of the arrangements and measures to be taken to limit the damages consequent of the failure within acceptable limits
- provide the Master and crew of the ship with data to generate comprehensive training, operational and maintenance programmes and documentation.

### 1.3 Sister ships

**1.3.1** For ships of the same design and having the same equipment, one FMEA on any one of such ships may be sufficient, but each of the other ships are to be subject to the same FMEA conclusion trials.

### 1.4 FMEA basics

**1.4.1** Before proceeding with a detailed FMEA into the effects of the failure of the system elements on the system functional output it is necessary to perform a functional failure analysis of the considered systems. In this way only systems which fail the functional failure analysis need to be investigated by a more detailed FMEA.

#### 1.4.2 Operational modes

When conducting a system FMEA the following typical operational modes within the normal design environmental conditions of the ships are to be considered:

- normal seagoing conditions at full speed
- maximum permitted operating speed in congested waters
- manoeuvring alongside
- seagoing conditions in emergency, as defined in Ch 2, Sec 1, Ch 2, Sec 2 and Ch 2, Sec 3.

### 1.4.3 Functional interdependence

This functional interdependence of these systems is also to be described in either block diagrams or fault tree diagrams or in a narrative format to enable the failure effects to be understood. As far as applicable, each of the systems to be analysed is assumed to fail in the following failure modes:

- a) complete loss of function
- b) rapid change to maximum or minimum output
- c) uncontrolled or varying output
- d) premature operation
- e) failure to operate at a prescribed time
- f) failure to cease operation at a prescribed time.

Depending on the system under consideration other failure modes may have to be taken into account.

### 1.4.4 Systems which can fail without catastrophic effects

If a system can fail without any hazardous or catastrophic effect, there is no need to conduct a detailed FMEA into the system architecture. For systems whose individual failure can cause hazardous or catastrophic effects and where a redundant system is not provided, a detailed FMEA as described in the following paragraphs should be followed.

Results of the system functional failure analysis should be documented and confirmed by a practical test programme drawn up from the analysis.

### 1.4.5 Redundant systems

Where a system, the failure of which may cause a hazardous or catastrophic effect, is provided with a redundant system, a detailed FMEA may not be required provided that:

- a) the redundant system can be put into operation or can take over the failed system within the time-limit dictated by the most onerous operational mode without endangering the ship
- b) the redundant system is completely independent from the system and does not share any common system element the failure of which would cause failure of both the system and the redundant system. Common system element may be acceptable if the probability of failure complies with [4].
- c) the redundant system may share the same power source as the system. In such case an alternative power source should be readily available with regard to the requirement of a) above.

The probability and effects of operator error to bring in the redundant system are also to be considered.

## 1.5 FMEA analysis

**1.5.1** The systems to be subject to a more detailed FMEA investigation at this stage are to include all those that have failed the system FMEA and may include those that have a very important influence on the safety of the ship and its occupants and which require an investigation at a deeper level than that undertaken in the system functional failure analysis. These systems are often those which have been specifically designed or adapted for the ship, such as the craft's electrical and hydraulic systems.

## 2 FMEA performance

### 2.1 Procedures

**2.1.1** The following steps are necessary to perform an FMEA:

- a) to define the system to be analysed
- b) to illustrate the interrelationships of functional elements of the system, by means of block diagrams
- c) to identify all potential failure modes and their causes
- d) to evaluate the effects on the system of each failure mode
- e) to identify failure detection methods
- f) to identify corrective measures for failure modes
- g) to assess the probability of failures causing hazardous or catastrophic effects, where applicable
- h) to document the analysis
- i) to develop a test programme
- j) to prepare FMEA report.

### 2.2 System definition

**2.2.1** The first step in an FMEA study is a detailed study of the system to be analysed, through the use of drawings and equipment manuals. A narrative description of the system and its functional requirements is to be drawn up including the following information:

- a) general description of system operation and structure
- b) functional relationship among the system elements
- c) acceptable functional performance limits of the system and its constituent elements in each of the typical operational modes
- d) system constraints.

### 2.3 Development of system block diagram

#### 2.3.1 Block diagram

The next step is to develop block diagram(s) showing the functional flow sequence of the system, both for technical understanding of the functions and operation of the system, and for the subsequent analysis. As a minimum the block diagram is to contain:

- a) breakdown of the system into major sub-systems or equipment
- b) all appropriate labelled inputs and outputs and identification numbers by which each sub-system is consistently referenced
- c) all redundancies, alternative signal paths and other engineering features which provide "fail-safe" measures.

#### 2.3.2 Block diagrams and operational modes

It may be necessary to have a different set of block diagrams prepared for each different operational modes.

## 2.4 Identification of failure modes, causes and effects

### 2.4.1 Failure mode

Failure mode is the manner by which a failure is observed. It generally describes the way the failure occurs and its impact on the equipment or system. As an example, a list of failure modes is given in Tab 1. The failure modes listed in Tab 1 can describe the failure of any system element in sufficiently specific terms. When used in conjunction with performance specifications governing the inputs and outputs on the system block diagram, all potential failure modes can be thus identified and described. Thus, for example, a power supply may have a failure mode described as “loss of output” (29), and a failure cause “open (electrical)” (31).

**Table 1 : Example of failure mode list**

1	Structural failure (rupture)
2	Physical binding or jamming
3	Vibration
4	Fails to remain in position
5	Fails to open
6	Fails to close
7	Fails open
8	Fails closed
9	Internal leakage
10	External leakage
11	Fails out of tolerance (high)
12	Fails out of tolerance (low)
13	Inadvertent operation
14	Intermittent operation
15	Erratic operation
16	Erroneous indication
17	Restricted flow
18	False actuation
19	Fails to stop
20	Fails to start
21	Fails to switch
22	Premature operation
23	Delayed operation
24	Erroneous input (increased)
25	Erroneous input (decreased)
26	Erroneous output (increased)
27	Erroneous output (decrease)
28	Loss of input
29	Loss of output
30	Shorted (electrical)
31	Open (electrical)
32	Leakage (electrical)
33	Other unique failure conditions as applicable to the system characteristics, requirements and operational constraints

### 2.4.2 System failure

A failure mode in a system element could also be the failure cause of a system failure. For example, the hydraulic line of a steering gear system might have a failure mode of “external leakage” (10). This failure mode of the hydraulic line could become a failure cause of the steering gear system’s failure mode “loss of output” (29).

### 2.4.3 Top-down approach

Each system should be considered in a top-down approach, starting from the system’s functional output, and failure is to be assumed by one possible cause at a time. Since a failure mode may have more than one cause, all potential independent causes for each failure mode are to be identified.

### 2.4.4 Delay effect when operating back-up systems

If major systems can fail without any adverse effect there is no need to consider them further unless the failure can go undetected by an operator. To decide that there is no adverse effect does not mean just the identification of system redundancy. The redundancy is to be shown to be immediately effective or brought on line with negligible time lag. In addition, if the sequence is: “failure - alarm - operator action - start of back up - back up in service”, the effects of delay should be considered.

## 2.5 Failure effects

### 2.5.1 Concept

The consequence of a failure mode on the operation, function, or status of an equipment or a system is called a “failure effect”. Failure effects on a specific sub-system or equipment under consideration are called “local failure effects”. The evaluation of local failure effects will help to determine the effectiveness of any redundant equipment or corrective action at that system level. In certain instances, there may not be a local effect beyond the failure mode itself.

### 2.5.2 End effect

The impact of an equipment or sub-system failure on the system output (system function) is called an “end effect”. End effects should be evaluated and their severity classified in accordance with the following categories:

- a) catastrophic
- b) hazardous
- c) major
- d) minor.

The definition of these four categories of failure effects is in [4].

### 2.5.3 Catastrophic and hazardous effects

If the end effect of a failure is classified as hazardous or catastrophic, back-up equipment is usually required to prevent or minimize such effect. For hazardous failure effects corrective operational procedures may be generally accepted.

## 2.6 Failure detection

### 2.6.1 Detectable failures

The FMEA study in general only analyses failure effects based on a single failure in the system and therefore a failure detection means, such as visual or audible warning devices, automatic sensing devices, sensing instrumentation or other unique indications, is to be identified.

### 2.6.2 Non detectable failures

Where the system element failure is non-detectable (i.e. a hidden fault or any failure which does not give any visual or audible indication to the operator) and the system can continue with its specific operation, the analysis is to be extended to determine the effects of a second failure, which in combination with the first undetectable failure may result in a more severe failure effect e.g. hazardous or catastrophic effect.

## 2.7 Corrective measures

### 2.7.1 Back-up equipment response

The response of any back-up equipment, or any corrective action initiated at a given system level to prevent or reduce the effect of the failure mode of system element or equipment, is also to be identified and evaluated.

### 2.7.2 Corrective design provisions

Provisions which are features of the design at any system level to nullify the effects of a malfunction or failure, such as controlling or deactivating system elements to halt generation or propagation of failure effects, activating back-up or standby items or systems, are to be described. Corrective design provisions include:

- a) redundancies that allow continued and safe operation
- b) safety devices, monitoring or alarm provisions, which permit restricted operation or limit damage
- c) alternative modes of operation.

### 2.7.3 Manual corrective actions

Provisions which require operator action to circumvent or mitigate the effects of the postulated failure are to be described. The possibility and effect of operator error is to be considered, if the corrective action or the initiation of the redundancy requires operator input, when evaluating the means to eliminate the local failure effects.

### 2.7.4 Acceptability of corrective action

It is to be noted that corrective responses acceptable in one operational mode may not be acceptable at another, e.g. a redundant system element with considerable time lag to be brought into line, while meeting the operational mode "normal seagoing conditions at full speed" may result in a catastrophic effect in another operational mode, e.g. "maximum permitted operating speed in congested water".

**Table 2 : FMEA worksheet**

Name of system: Mode of operation: Sheet No: Date: Name of analyst:					References: System block diagram:  Drawings:						
Equipment name or number	Function	Ident. No.	Failure mode	Failure cause	Failure effect		Failure detection	Corrective action	Severity of failure effect	Probability of failure (if applicable)	Remarks
					Local effect	End effect					

## 2.8 Use of probability concept

### 2.8.1 Acceptance criteria

If corrective measures or redundancy as described in preceding paragraphs are not provided for any failure, as an alternative the probability of occurrence of such failure is to meet the following criteria of acceptance:

- a) a failure mode which results in a catastrophic effect is to be assessed to be extremely improbable
- b) a failure mode assessed as extremely remote is to not result in worse than hazardous effects
- c) a failure mode assessed as either frequent or reasonably probable is not to result in worse than minor effects.

### 2.8.2 Data

Numerical values for various levels of probabilities are laid down in [4]. In areas where there is no data from ships to determine the level of probabilities of failure other sources can be used such as:

- a) workshop test
- b) history of reliability used in other areas under similar operating conditions
- c) mathematical model if applicable.

## 2.9 Documentation

### 2.9.1 Worksheet

It is helpful to perform FMEA on worksheets. Tab 2 shows an example of worksheet.

### 2.9.2 Worksheet organization

The worksheets are to be organized to first display the highest system level and then proceed down through decreasing system levels.

## 3 Tests and reporting

### 3.1 Test program

#### 3.1.1 FMEA validation test

An FMEA test programme is to be drawn up to prove the conclusions of FMEA. It is recommended that the test programme is to include all systems or system elements whose failure would lead to:

- a) major or more severe effects
- b) restricted operations
- c) any other corrective action.

For equipment where failure cannot be easily simulated on the ship, the results of other tests can be used to determine the effects and influences on the systems and ship

#### 3.1.2 Further investigations

The trials are also to include investigations into:

- a) the layout of control stations with particular regard to the relative positioning of switches and other control devices to ensure a low potential for inadvertent and incorrect crew action, particularly during emergencies and the provision of interlocks to prevent inadvertent operation for important system operation

- b) the existence and quality of the craft's operational documentation with particular regard to the pre-voyage checklists. It is essential that these checks account for any unrevealed failure modes identified in the failure analysis
- c) the effects of the main failure modes as prescribed in the theoretical analysis.

## 3.2 Reporting

**3.2.1** The FMEA report is to be a self-contained document with a full description of the craft, its systems and their functions and the proposed operation and environmental conditions for the failure modes, causes and effects to be understood without any need to refer to other plans and documents not in the report. The analysis assumptions and system block diagrams are to be included, where appropriate.

The report is to contain a summary of conclusions and recommendations for each of the systems analysed in the system failure analysis and the equipment failure analysis. It is also to list all probable failures and their probability of failure where applicable, the corrective actions or operational restrictions for each system in each of the operational modes under analysis. The report is to contain the test programme, reference any other test reports and the FMEA trials.

## 4 Probabilistic concept

### 4.1 General

**4.1.1** Different undesirable events may have different orders of acceptable probability. In connection with this, it is convenient to agree on standardized expressions to be used to convey the relatively acceptable probabilities of various occurrences, i.e. to perform a qualitative ranking process.

### 4.2 Occurrences

#### 4.2.1 Occurrence

Occurrence is a condition involving a potential lowering of the level of safety.

#### 4.2.2 Failure

Failure is an occurrence in which a part, or parts, of the ship fail. A failure includes:

- a) a single failure
- b) independent failures in combinations within a system, and
- c) independent failures in combinations involving more than one system, taking into account:
  - 1) any undetected failure that is already present
  - 2) such further failures as would be reasonably expected to follow the failure under consideration, and
- d) common cause failure (failure of more than one component or system due to the same cause).

Note 1: In assessing the further failures which follow, account should be taken of any resulting more severe operating conditions for items that have not up to that time failed.



### 4.2.3 Event

Event is an occurrence which has its origin outside the craft (e.g., waves).

### 4.2.4 Error

Error is an occurrence arising as a result of incorrect action by the operating crew or maintenance personnel.

## 4.3 Probability of occurrences

### 4.3.1 Frequent

Frequent is one which is likely to occur often during the operational life of a particular ship.

### 4.3.2 Reasonably probable

Reasonably probable is one which is unlikely to occur often but which may occur several times during the total operational life of a particular ship.

### 4.3.3 Recurrent

Recurrent is a term embracing the total range of frequent and reasonably probable.

### 4.3.4 Remote

Remote is one which is unlikely to occur to every ship but may occur to a few ships of a type over the total operational life of a number of ship of the same type.

### 4.3.5 Extremely remote

Extremely remote is one which is unlikely to occur when considering the total operational life of a number of ships of the type, but nevertheless should be considered as being possible.

### 4.3.6 Extremely improbable

Extremely improbable is one which is so extremely remote that it should not be considered as possible to occur.

## 4.4 Effects

### 4.4.1 Effect

Effect is a situation arising as a result of an occurrence.

### 4.4.2 Minor effect

Minor effect is an effect which may arise from a failure, an event, or an error which can be readily compensated for by the operating crew; it may involve:

- a small increase in the operational duties of the crew or in their difficulty in performing their duties, or
- a moderate degradation in handling characteristics, or
- slight modification of the permissible operating conditions.

### 4.4.3 Major effect

Major effect is an effect which produces:

- a significant increase in the operational duties of the crew or in their difficulty in performing their duties which by itself should not be outside the capability of a competent crew provided that another major effect does not occur at the same time, or
- significant degradation in handling characteristics, or
- significant modification of the permissible operating conditions, but will not remove the capability to complete a safe journey without demanding more than normal skill on the part of the operating crew.

**Table 3 :**

Effect	Criteria not to be exceeded	Value (2)	Comment
	Type of load		
LEVEL 1 MINOR EFFECT Moderate degradation of safety	Maximum acceleration measured horizontally (1)	0,20 g	0,08 g and 0,20 g/s (3) Elderly person will keep balance when holding 0,15 g and 0, 20 g/s Mean person will keep balance when holding 0,15 g and 0,80 g/s Sitting person will start holding
LEVEL 2 MAJOR EFFECT Significant degradation of safety	Maximum acceleration measured horizontally (1)	0,35 g	0,25 g and 2 g/s Maximum load for mean person keeping balance when holding 0,45 g and 10 g/s Mean person fails out of seat when not wearing seat belts
LEVEL 3 HAZARDOUS EFFECT Major degradation of safety	Collision design condition calculated Maximum structural design load, based on vertical acceleration at centre of gravity	1 g	Risk of injury to persons, safe emergency operation after collision 1 g Degradation of person safety
LEVEL 4 CATASTROPHIC EFFECT		1 g	Loss of ship and/or fatalities
<p>(1) The recording instruments used are to be such that the acceleration accuracy is better than 5% of the real value and frequency response is to be minimum 20 Hz. Antialiasing filters with maximum passband attenuation 100 + 5% are to be used</p> <p>(2) g = gravity acceleration (9,81 m/s<sup>2</sup>)</p> <p>(3) g-rate of jerk may be evaluated from acceleration/time curves.</p>			

**4.4.4 Hazardous effect**

Hazardous effect is an effect which produces:

- a) a dangerous increase in the operational duties of the crew or in their difficulty in performing their duties of such magnitude that they cannot reasonably be expected to cope with them and will probably require outside assistance, or
- b) dangerous degradation of handling characteristics, or
- c) dangerous degradation of the strength of the ship, or
- d) marginal conditions for, or injury to, occupants, or
- e) an essential need for outside rescue operations.

**4.4.5 Catastrophic effect**

Catastrophic effect is an effect which results in the loss of the craft and/or in fatalities.

**4.5 Safety level**

**4.5.1** Safety level is a numerical value characterizing the relationship between ship performance represented as horizontal single amplitude acceleration (g) and rate of acceleration (g/s) and the severity of acceleration-load effects on standing and sitting humans. The safety levels and the corresponding severity of effects on passengers and safety criteria for ship performance are defined in Tab 3.

**4.6 Numerical values**

**4.6.1** Where numerical probabilities are used in assessing compliance with requirements using the terms similar to those given above, the approximate values given in Tab 4 may be used as guidelines to assist in providing a common point of reference. The probabilities quoted should be on an hourly or per journey basis, depending on which is more appropriate to the assessment in question.

Note 1: Different occurrences may have different acceptable probabilities, according to the severity of their consequences (see Tab 5).

**Table 4 :**

Frequent	More than 10 <sup>-3</sup>
Reasonably probable	10 <sup>-3</sup> to 10 <sup>-5</sup>
Remote	10 <sup>-5</sup> to 10 <sup>-7</sup>
Extremely remote	10 <sup>-7</sup> to 10 <sup>-9</sup>
Extremely improbable	Whilst no approximate numerical probability is given for this, the figures used should be substantially less than 10 <sup>-9</sup>

**Table 5 :**

SAFETY LEVEL	1		1	2		3	4
EFFECT ON SHIP AND OCCUPANTS	Normal	Nuisance	Operating limitations	Emergency procedures; significant reduction in safety margins; difficult for crew to cope with adverse conditions; person injuries	Large reduction in safety margin; crew overburden because of workload or environmental conditions; serious injuries to small number of persons	Casualties and deaths, usually with loss of ship	
F.A.R. PROBABILITY (1)	Probable			Improbable		Extremely improbable	
JAR-25 PROBABILITY (2)	Probable			Improbable		Extremely improbable	
	Frequent		Reasonably probable	Remote	Extremely remote		
	10 <sup>-0</sup>	10 <sup>-2</sup>	10 <sup>-3</sup>	10 <sup>-5</sup>	10 <sup>-7</sup>	10 <sup>-9</sup>	
CATEGORY OF EFFECT	Minor			Major	Hazardous	Catastrophic	
(1) The United States Federal Aviation Regulation							
(2) European Joint Airworthiness Regulations							

Part F  
**Additional Class Notations**

Chapter 3

**AUTOMATION SYSTEMS (AUT)**

---

- SECTION 1 UNATTENDED MACHINERY SPACES (AUT-UMS)**
- SECTION 2 CENTRALISED CONTROL STATION (AUT-CCS)**
- SECTION 3 AUTOMATED OPERATION IN PORT (AUT-PORT)**
- SECTION 4 INTEGRATED MACHINERY SPACES (AUT-IMS)**



## SECTION 1

## UNATTENDED MACHINERY SPACES (AUT-UMS)

### 1 General

#### 1.1 Application

**1.1.1** The additional class notation **AUT-UMS** is assigned in accordance with Pt A, Ch 1, Sec 2, [6.4.2] to ships fitted with automated installations enabling periodically unattended operation of machinery spaces, and complying with the requirements of this Section.

Note 1: Machinery spaces are defined in Pt C, Ch 4, Sec 1, [3.23.1].

**1.1.2** *The arrangements provided shall be such as to ensure that the safety of the ship in all sailing conditions, including manoeuvring, is equivalent to that of a ship having the machinery spaces manned.*

**1.1.3** The requirements of this Section are additional to the general rule requirements applicable to the ships.

**1.1.4** For ships not covered by SOLAS, the following requirements are applicable:

- control of electrical installations: Pt C, Ch 2, Sec 3, [2.2.7], Pt C, Ch 2, Sec 3, [2.2.8] and Pt C, Ch 2, Sec 3, [2.2.9]
- arrangements of remote stop: Pt C, Ch 4, Sec 2, [2.1]
- arrangements of machinery spaces: Pt C, Ch 4, Sec 6, [4.1.2].

#### 1.2 Exemptions

**1.2.1** For ships whose gross tonnage is less than 500 and propulsive power less than 1 MW, the requirements laid down in [5.4.3] do not apply.

**1.2.2** For ships whose gross tonnage is less than 500 and propulsive power per main engine less than 1 MW, the requirements laid down in [4], except [4.1.3], do not apply.

Diesel engines installed on ships are to be equipped with:

a) Indicators, as detailed below:

- for auxiliary engine of 1000 kW and above:
  - The requirements laid down in Pt C, Ch 1, Sec 2, Tab 4, Pt C, Ch 1, Sec 2, Tab 5 and Pt C, Ch 1, Sec 2, Tab 6 apply
- for propulsion engine or auxiliary engine with a power less than 1000 kW:
  - lubrication oil pressure indication
  - fresh water temperature indication.

The indicators are to be fitted at a normally centralised control position.

b) Alarms, as detailed below:

- for auxiliary engine of 1000 kW and above:
  - The requirements laid down in Pt C, Ch 1, Sec 2, Tab 4, Pt C, Ch 1, Sec 2, Tab 5 and Pt C, Ch 1, Sec 2, Tab 6 apply
- for propulsion engine or auxiliary engine with a power less than 1000 kW:
  - lubrication oil low pressure alarm
  - very low lubricating oil pressure alarm
  - overspeed alarm.

The alarms are to be visual and audible at a centralised control position.

c) Automatic control, as detailed below:

- for auxiliary engine of 1000 kW and above:
  - The requirements laid down in Pt C, Ch 1, Sec 2, Tab 4, Pt C, Ch 1, Sec 2, Tab 5 and Pt C, Ch 1, Sec 2, Tab 6 apply
- for propulsion engine or auxiliary engine with a power less than 1000 kW:
  - shut-down on very low lubricating oil pressure
  - shut-down on overspeed.

**1.2.3** For ships whose gross tonnage is less than 500 and propulsive power less than 1 MW, automatic stop is to be provided for lubricating oil failure of engines, reduction gears, clutches and reversing gears. A possible override of this automatic stop is to be available at the control stations, and an indication is to be provided at each control station, when override is activated.

**1.2.4** The requirements laid down in [3.3.1] do not apply to cargo ships of less than 1 600 tons gross tonnage, insofar as the arrangements of the machinery space access make it unnecessary.

**1.2.5** Fishing vessels of less than 45 m in length are exempted from the application of:

- alarm system requirements given in [5.2.3] and [5.4.2]
- fire detection system requirements given in [3.2] insofar as the location of the spaces considered allows people on board to detect fire outbreaks easily, and
- requirements given in [3.4.3].

**1.2.6** Fishing vessels of less than 75 m in length are exempted from the application of the requirements laid down in [1.3.2], [3.1.2] and [3.3.1].

### 1.3 Communication system

**1.3.1** A reliable means of vocal communication shall be provided between the main machinery control room or the propulsion machinery control position as appropriate, the navigation bridge and the engineer officers' accommodation.

This means of communication is to be foreseen in collective or individual accommodation of engineer officers.

**1.3.2** Means of communication are to be capable of being operated at least half an hour even in the event of failure of supply from the main source of electrical power (black-out).

## 2 Documentation

### 2.1 Documents to be submitted

**2.1.1** In addition to those mentioned in Pt C, Ch 3, Sec 1, Tab 1, the documents in Tab 1 are required.

**Table 1 : Documents to be submitted**

No.	I/A (1)	Document
1	A	Means of communication diagram
2	A	Technical description of automatic engineer's alarm and connection of alarms to accommodation and bridge, when applicable
3	A	System of protection against flooding
4	A	Fire detection system: diagram, location and cabling
(1) A : to be submitted for approval I : to be submitted for information.		

## 3 Fire and flooding precautions

### 3.1 Fire prevention

**3.1.1** Where daily service oil fuel tanks are filled automatically, or by remote control, means shall be provided to prevent overflow spillages.

**3.1.2** Where heating is necessary, it is to be arranged with automatic control. A high temperature alarm is to be fitted and the possibility of adjusting its threshold according to the fuel quality is to be provided. Such alarm may be omitted if it is demonstrated that the temperature in the tank cannot exceed the flashpoint under the following conditions: volume of liquid corresponding to the low level alarm and maximum continuous heating power during 24 hours.

### 3.2 Fire detection

**3.2.1** For fire detection, the requirements given in Pt C, Ch 4, Sec 3 are applicable.

**3.2.2** Means are to be provided to detect and give alarms at an early stage in case of fires:

- in boiler air supply casing and exhausts (uptakes), and
- in scavenging air belts of propulsion machinery

unless the Society considers this to be unnecessary in a particular case.

Especially, it is deemed unnecessary to provide means to detect fires at an early stage and give alarms in the following cases:

- For boilers with no inherent fire risk in the air supply casing, i.e. boilers with no heat exchangers (e.g. rotary heat exchangers) having surfaces exposed alternately to air and flue gas.
- For boilers with no inherent fire risk in the flue gas uptake, i.e. boilers with no heat exchangers using flue gases as the heating medium e.g. air/water preheaters or economisers.

Note 1: "flue gas" means exhaust gas from boiler furnace.

### 3.2.3 Location of fire detectors for boilers

The means to detect and give alarms at an early stage in cases of fires in boiler air supply casing and exhausts are to be located at a representative location:

- Either in the air supply casing or in the fuel gas uptake for boilers with heat exchangers having surfaces exposed alternatively to air and flue gas.
- In the flue gas uptake for boilers with heat exchangers using flue gases as the heating medium e.g. air/water preheaters or economisers.

**3.2.4** An automatic fire detection system is to be fitted in machinery spaces of category A, as defined in Pt C, Ch 4, Sec 1, [3.24.1], intended to be unattended.

**3.2.5** The fire detection system is to be designed with self-monitoring properties. Power or system failures are to initiate an audible alarm distinguishable from the fire alarm.

**3.2.6** The fire detection indicating panel is to be located on the navigating bridge, fire control station, or other accessible place where a fire in the machinery space will not render it inoperative.

**3.2.7** The fire detection indicating panel is to indicate the place of the detected fire in accordance with the arranged fire zones by means of a visual signal. Audible signals clearly distinguishable in character from any other signals are to be audible throughout the navigating bridge and the accommodation area of the personnel responsible for the operation of the machinery space.

**3.2.8** Fire detectors are to be of such type and so located that they will rapidly detect the onset of fire in conditions normally present in the machinery space. Consideration is to be given to avoiding false alarms. The type and location of detectors are to be approved by the Society and a combination of detector types is recommended in order to enable the system to react to more than one type of fire symptom.

**3.2.9** Except in spaces of restricted height and where their use is specially appropriate, detection systems using thermal detectors only are not permitted. Flame detectors may be installed, although they are to be considered as complementary and are not to replace the main installation.

**3.2.10** Fire detector zones are to be arranged in a manner that will enable the operating staff to locate the seat of the fire. The arrangement and the number of loops and the location of detector heads are to be approved in each case. Air currents created by the machinery are not to render the detection system ineffective.

**3.2.11** When fire detectors are provided with the means to adjust their sensitivity, necessary arrangements are to be allowed to fix and identify the set point.

**3.2.12** When it is intended that a particular loop or detector is to be temporarily switched off, this state is to be clearly indicated. Reactivation of the loop or detector is to be performed automatically after a preset time.

**3.2.13** The fire detection indicating panel is to be provided with facilities for functional testing.

**3.2.14** The fire detecting system is to be fed automatically from the emergency source of power by a separate feeder if the main source of power fails.

**3.2.15** Facilities are to be provided in the fire detecting system to manually release the fire alarm from the following places:

- passageways having entrances to engine and boiler rooms
- the navigating bridge
- the control station in the engine room.

**3.2.16** The detection equipment is to be so designed as to signal in less than 3 minutes a conventional seat of fire resulting from the combustion of 500 g textile waste impregnated with 25 cl of diesel oil in a square gutterway 30 cm wide x 15 cm high. Alternative means of testing may be accepted at the discretion of the Society.

### 3.3 Fire fighting

**3.3.1** Unless otherwise stated, pressurisation of the fire main at a suitable pressure by starting a main fire pump and carrying out the other necessary operations is to be possible from the navigation bridge and fire control station. Alternatively, the fire main system may be permanently under pressure.

**3.3.2** The arrangements for the ready availability of water supply are to be:

- in passenger ships of 1 000 gross tonnage and upwards, such that at least one effective jet of water is immediately available from any hydrant in an interior location and so as to allow the continuation of the output of water by the automatic starting of a required fire pump
- in passenger ships of less than 1 000 gross tonnage and in cargo ships, to the satisfaction of the Society.

**3.3.3** In addition to the fire-extinguishing arrangements mentioned in Part C, Chapter 4, periodically unattended spaces containing steam turbines (whose power is at least 375 kW) are to be provided with one of the fixed fire-extinguishing systems required in the same chapter for machinery spaces of category A containing oil fired boilers or fuel oil units.

**3.3.4** Local application fire-extinguishing system provided in machinery spaces of category A in accordance with Pt C, Ch 4, Sec 6, [4.7.2] are to have an automatic release capability in addition to the manual release.

### 3.4 Protection against flooding

**3.4.1** Bilge wells or machinery spaces bilge levels are to be monitored in such a way that the accumulation of liquid is detected in normal angles of trim and heel, and are to be large enough to accommodate easily the normal drainage during the unattended period.

**3.4.2** *Where the bilge pumps are capable of being started automatically, means shall be provided to indicate when the influx of liquid is greater than the pump capacity or when the pump is operating more frequently than would normally be expected.*

**3.4.3** In addition to the requirements provided in this Section, the location of controls of any valve serving a sea inlet, a discharge below the waterline or a bilge injection system is to comply with Pt C, Ch 1, Sec 10, [5.5.4].

**3.4.4** Bilge level alarms are to be given at the main control station and the navigating bridge.

**3.4.5** Alarm is to be given to the navigating bridge in case of flooding into the machinery space situated below the load line.

## 4 Control of machinery

### 4.1 General

**4.1.1** *Under all sailing conditions, including manoeuvring, the speed, direction of thrust and, if applicable, the pitch of the propeller shall be fully controllable from the navigation bridge.*

**4.1.2** All manual operations or services expected to be carried out with a periodicity of less than 24 h are to be eliminated or automated, particularly for: lubrication, topping up of make up tanks and filling tanks, filter cleaning, cleaning of centrifugal purifiers, drainage, load sharing on main engines and various adjustments. Nevertheless, the transfer of operation mode may be effected manually.

**4.1.3** *A centralised control position shall be arranged with the necessary alarm panels and instrumentation indicating any alarm.*

**4.1.4** Parameters for essential services which need to be adjusted to a preset value are to be automatically controlled.

**4.1.5** The control system shall be such that the services needed for the operation of the main propulsion machinery and its auxiliaries are ensured through the necessary automatic arrangements.

**4.1.6** *It shall be possible for all machinery essential for the safe operation of the ship to be controlled from a local position, even in the case of failure in any part of the automatic or remote control systems.*

**4.1.7** *The design of the remote automatic control system shall be such that in the case of its failure an alarm will be given. Unless impracticable, the preset speed and direction of thrust of the propeller shall be maintained until local control is in operation.*

**4.1.8** Critical speed ranges, if any, are to be rapidly passed over by means of an appropriate automatic device.

**4.1.9** Propulsion machinery is to stop automatically only in exceptional circumstances which could cause quick critical damage, due to internal faults in the machinery. The design of automation systems whose failure could result in an unexpected propulsion stop is to be specially examined. An overriding device for cancelling the automatic shutdown is to be considered.

Automatic slow down of propulsion machinery may be omitted during crash astern sequence.

**4.1.10** Where the propulsive plant includes several main engines, a device is to be provided to prevent any abnormal overload on each of them.

**4.1.11** *Where standby machines are required for other auxiliary machinery essential to propulsion, automatic change-over devices shall be provided.*

**4.1.12** The additional remote indications to be displayed at the centralised control position, shown with the symbol "R" in the following tables Tab 2 to Tab 29, are required for AUT-CCS notation only, as mentioned in Ch 3, Sec 2, [4.1.2].

## 4.2 Diesel propulsion plants

**4.2.1** When a diesel engine is used for the propulsion plant, monitoring and control of equipment is to be performed according to Tab 2 for cross-head (slow speed) engines or Tab 3 for trunk-piston (medium or high speed) engines.

## 4.3 Steam propulsion plants

**4.3.1** For steam propulsion plants, control and monitoring functions of steam turbines are required according to Tab 4.

**4.3.2** Turbine spinning is to take place automatically at regular intervals when the shaft line is stopped during manoeuvring.

**4.3.3** Spinning is not allowed until the equipment is in a safe position.

**4.3.4** Lubrication of gear and turbines is to be automatically ensured until the plant is stopped (driven oil pump or gravity tank).

**4.3.5** If a special crash astern sequence is provided, it is to be carried out through a separate device or by placing the control gear in a special position; precautions are to be taken to avoid its unintended use.

According to the type of plant, this control may be achieved by:

- cancelling the low vacuum shutdown device
- shutting off the steam to the ahead turbine
- opening the turbine cylinder drain valves, the astern stop valve and the astern manoeuvring valve.

**4.3.6** For steam propulsion plants, control and monitoring functions of main boilers are required according to Tab 5.

**4.3.7** Additional arrangements may be required according to the type of boilers considered, in particular in the case of forced circulation boilers, concerning unexpected circulation shutdown.

Reheat cycle type boilers are also to be subjected to a special examination.

**4.3.8** Where the propulsive plant includes several main boilers, automatic shutdown of one is to involve automatic slowdown of the turbines with a view to saving the maximum available steam for electricity production.

**4.3.9** Unless special arrangements are provided, fire in boiler air ducts is to be detected.

**4.3.10** For evaporators associated to steam propulsion plants, control, alarm and monitoring functions are required according to Tab 6.

## 4.4 Gas turbine propulsion plants

**4.4.1** For gas turbines, monitoring and control elements are required according to Tab 7.

## 4.5 Gas-only and dual fuel engines

**4.5.1** For ships assigned with additional service feature LNGfuel, CNGfuel or LPGfuel or, as relevant, other service features defined in Pt A, Ch 1, Sec 2, [4.13], control and monitoring functions of gas-only and dual fuel engines are to be in compliance with NR529.



Table 2 : Main propulsion cross-head (slow speed) diesel engine

Symbol convention H = High, HH = High high, G = group alarm L = Low, LL = Low low, I = individual alarm X = function is required, R = remote (AUT-CCS only)	Monitoring		Automatic control				
			Main Engine			Auxiliary	
Identification of system parameter	Alarm (1)	Indication	Slow-down	Shut-down	Control	Standby Start	Stop
<b>Fuel oil system</b>							
• Fuel oil pressure after filter (engine inlet)	L	R				X	
• Fuel oil viscosity before injection pumps or fuel oil temperature before injection pumps (for engine running on heavy fuel)	H + L				X		
• Leakage from high pressure pipes where required	H						
• Common rail fuel oil pressure	L						
<b>Lubricating oil system</b>							
• Lubricating oil to main bearing and thrust bearing pressure	L	R	X				X
	LL			X			
• Lubricating oil to crosshead bearing pressure when separate	L	R	X				X
	LL			X			
• Lubricating oil to camshaft pressure when separate	L						X
	LL			X			
• Lubricating oil to camshaft temperature when separate	H				X		
• Lubricating oil inlet temperature	H				X		
• Thrust bearing pad temperature or bearing oil outlet temperature	H	local	X				
	HH			X			
• Activation of oil mist detection arrangements (2) (10)	X		X				
• Crankcase oil mist detector failure	X						
• Flow rate cylinder lubricator (each apparatus)	L		X				
• Level in lubricating oil tanks or oil sump, as appropriate (3)	L						
• Common rail servo oil pressure	L						
• Lubricating oil to turbocharger inlet pressure (4)	L						
• Turbocharger lubricating oil outlet temperature on each bearing (5)	H						
<b>Piston cooling system</b>							
• Piston coolant inlet pressure	L		X (6)				X
• Piston coolant outlet temperature on each cylinder	H	local	X				
• Piston coolant outlet flow on each cylinder (7)	L	local	X				
• Level of piston coolant in expansion tank	L						
<b>Sea water cooling system</b>							
• Sea water cooling pressure	L						X

Symbol convention H = High, HH = High high, G = group alarm L = Low, LL = Low low, I = individual alarm X = function is required, R = remote (AUT-CCS only)	Monitoring		Automatic control				
			Main Engine			Auxiliary	
Identification of system parameter	Alarm (1)	Indication	Slow-down	Shut-down	Control	Standby Start	Stop
<b>Cylinder fresh cooling water system</b>							
• Cylinder fresh cooling water system inlet pressure	L	local (9)	X				
• Cylinder fresh cooling water outlet temperature or, when common cooling space without individual stop valves, the common cylinder water outlet temperature	H	local	X			X	
• Oily contamination of engine cooling water system (when main engine cooling water is used in fuel and lubricating oil heat exchangers)	X						
• Level of cylinder cooling water in expansion tank	L						
<b>Fuel valve coolant system</b>							
• Pressure of fuel valve coolant	L					X	
• Temperature of fuel valve coolant	H						
• Level of fuel valve coolant in expansion tank	L						
<b>Scavenge air system</b>							
• Scavenging air receiver pressure		R					
• Scavenging air box temperature (detection of fire in receiver, see [3.2.2])	H	local	X				
• Scavenging air receiver water level	H						
<b>Exhaust gas system</b>							
• Exhaust gas temperature after each cylinder	H	R	X				
• Exhaust gas temperature after each cylinder, deviation from average	H						
• Exhaust gas temperature before each turbocharger	H	R					
• Exhaust gas temperature after each turbocharger	H	R					
<b>Miscellaneous</b>							
• Speed of turbocharger (8)	H	R					
• Engine speed (and direction of speed when reversible)		R			X		
• Engine overspeed (9)	H			X			
• Wrong way	X						
• Control, safety, alarm system power supply failure	X						
<p>(1) Where alarm is associated to slowdown or shutdown, this alarm is to anticipate the action of shutdown and slowdown (pre-alarm).</p> <p>(2) For engines having a power of more than 2250 kW or a cylinder bore of more than 300 mm.</p> <p>(3) If separate lubricating oil tanks are installed, then an individual level alarm for each tank is required.</p> <p>(4) Unless provided with a self-contained lubricating oil system integrated with the turbocharger.</p> <p>(5) Where outlet temperature from each bearing cannot be monitored due to the engine/turbocharger design alternative arrangement may be accepted. Continuous monitoring of inlet pressure and inlet temperature in combination with specific intervals for bearing inspection in accordance with the turbocharger manufacturer's instructions may be accepted as an alternative.</p> <p>(6) Not required, if the coolant is oil taken from the main cooling system of the engine.</p> <p>(7) Where outlet flow cannot be monitored due to engine design, alternative arrangement may be accepted.</p> <p>(8) Only required for turbochargers of Categories B and C as defined in Pt C, Ch 1, Sec 14, [1.1.3].</p> <p>(9) For engines of 220 kW and above.</p> <p>(10) Activation of oil mist detection arrangements is equivalent to activation of the temperature monitoring systems, or equivalent devices, of:</p> <ul style="list-style-type: none"> <li>• the engine main, crank and crosshead bearing oil outlet; or</li> <li>• the engine main, crank and crosshead bearing</li> </ul>							

Table 3 : Main propulsion trunk-piston (medium or high speed) diesel engine

Symbol convention H = High, HH = High high, G = group alarm L = Low, LL = Low low, I = individual alarm X = function is required, R = remote (AUT-CCS only)	Monitoring		Automatic control				
			Main Engine			Auxiliary	
Identification of system parameter	Alarm (1)	Indication	Slow-down	Shut-down	Control	Standby Start	Stop
<b>Fuel oil system</b>							
• Fuel oil pressure after filter (engine inlet)	L	R					
						X	
• Fuel oil viscosity before injection pumps or fuel oil temperature before injection pumps (for engine running on heavy fuel)	H + L						
					X		
• Leakage from high pressure pipes where required	H						
• Common rail fuel oil pressure	L						
<b>Lubricating oil system</b>							
• Lubricating oil to main bearing and thrust bearing pressure	L	R					
	X					X	
	LL			X			
• Lubricating oil filter differential pressure	H	R					
• Lubricating oil inlet temperature	H	R					
					X		
• Activation of oil mist detection arrangements (2) (7)	X			X			
• Crankcase oil mist detector failure	X						
• Flow rate cylinder lubricator (each apparatus)	L		X				
• Common rail servo oil pressure	L						
• Lubricating oil to turbocharger inlet pressure (3)	L	R					
• Turbocharger lub oil temperature each bearing (4)	H						
<b>Sea water cooling system</b>							
• Sea water cooling pressure	L	R					
						X	
<b>Cylinder fresh cooling water system</b>							
• Cylinder water inlet pressure or flow	L	R	X				
						X	
• Cylinder water outlet temperature	H	R	X				
• Level of cylinder cooling water in expansion tank	L						
<b>Scavenge air system</b>							
• Scavenging air receiver temperature	H						
<b>Exhaust gas system</b>							
• Exhaust gas temperature after each cylinder (5)	H	R	X				
• Exhaust gas temperature after each cylinder (5), deviation from average	H						
<b>Miscellaneous</b>							
• Engine speed		R					
					X		
• Engine overspeed	H			X			
• Speed of turbocharger (6)	H	R					
• Control, safety, alarm system power supply failure	X						

Symbol convention H = High, HH = High high, G = group alarm L = Low, LL = Low low, I = individual alarm X = function is required, R = remote (AUT-CCS only)	Monitoring		Automatic control				
			Main Engine			Auxiliary	
Identification of system parameter	Alarm (1)	Indication	Slow-down	Shut-down	Control	Standby Start	Stop
<p>(1) Where alarm is associated to slowdown or shutdown, this alarm is to anticipate the action of shutdown and slowdown (pre-alarm).</p> <p>(2) For engine of 2250 kW and above or having cylinders of more than 300 mm bore: for each engine, one oil mist detector (or engine bearing temperature monitoring system or equivalent device) having two independent outputs for initiating the alarm and shut-down would satisfy the requirement for independence between alarm and shut-down systems.</p> <p>(3) Unless provided with a self contained lubricating oil system integrated with the turbocharger.</p> <p>(4) Where outlet temperature from each bearing cannot be monitored due to the engine/turbocharger design alternative arrangements may be accepted. Continuous monitoring of inlet pressure and inlet temperature in combination with specific intervals for bearing inspection in accordance with the turbocharger manufacturer's instructions may be accepted as an alternative.</p> <p>(5) For engine power &gt; 500 kW/cyl.</p> <p>(6) Only required for turbochargers of Categories B and C as defined in Pt C, Ch 1, Sec 14, [1.1.3].</p> <p>(7) Activation of oil mist detection arrangements is equivalent to activation of the temperature monitoring systems, or equivalent devices, of:</p> <ul style="list-style-type: none"> <li>the engine main and crank bearing oil outlet; or</li> <li>the engine main and crank bearing</li> </ul>							

**Table 4 : Steam turbines used for main propulsion**

Symbol convention H = High, HH = High high, G = group alarm L = Low, LL = Low low, I = individual alarm X = function is required, R = remote (AUT-CCS only)	Monitoring		Automatic control				
			Turbine			Auxiliary	
Identification of system parameter	Alarm	Indication	Slow-down	Shut-down	Control	Standby Start	Stop
<b>Lubricating oil system</b>							
<ul style="list-style-type: none"> <li>Supply pressure</li> </ul>						X	
	L						
	LL			X			
<ul style="list-style-type: none"> <li>Cooler inlet temperature</li> </ul>	H						
<ul style="list-style-type: none"> <li>Temperature of reduction gear bearings</li> </ul>	H (1)						
<ul style="list-style-type: none"> <li>Temperature of turbine bearings and thrust bearings</li> </ul>	H (1)						
<ul style="list-style-type: none"> <li>Level of return tank</li> </ul>	L (2)						
<ul style="list-style-type: none"> <li>Level of gravity tank</li> </ul>	L (2)						
<b>Miscellaneous</b>							
<ul style="list-style-type: none"> <li>Main turbine speed</li> </ul>		R			X		
	H			X			
<ul style="list-style-type: none"> <li>Main turbine vibration</li> </ul>	H						
	HH			X			
<ul style="list-style-type: none"> <li>Main turbine axial displacement</li> </ul>	H						
	HH			X			
<ul style="list-style-type: none"> <li>Automatic spinning fault</li> </ul>	X						
<ul style="list-style-type: none"> <li>Gland seals fault at exhaust fans</li> </ul>	X						
<ul style="list-style-type: none"> <li>Gland seals pressure of steam supply</li> </ul>	L + H						
<ul style="list-style-type: none"> <li>Superheated steam temperature</li> </ul>	L			X			
<p>(1) Alternatively: group alarm associated with means to find out the fault.</p> <p>(2) Sensor to be located near the normal level.</p>							

Table 5 : Main boilers

Symbol convention H = High, HH = High high, G = group alarm L = Low, LL = Low low, I = individual alarm X = function is required, R = remote (AUT-CCS only)	Monitoring		Automatic control				
			Main boiler			Auxiliary	
Identification of system parameter	Alarm	Indication	Slow-down	Shut-down	Control	Standby Start	Stop
<b>Fuel oil system</b>							
• Fuel oil delivery pressure or flow	L						
• Fuel oil temperature after heater or viscosity fault	L + H				X		
<b>Combustion</b>							
• Flame failure of each burner	X			X			
• Failure of atomising fluid	X						
• Boiler casing and economiser outlet smoke temperature (in order to detect possible fire outbreak)	H			X			
	HH						
• Burning air flow or equivalent	L						
<b>General steam system</b>							
• Superheated steam pressure	L + H	R			X		
• Superheated steam temperature	H						
• Desuperheated steam pressure (except if pressure is that of superheated steam)	L						
• Desuperheated steam temperature	H						
• Lifting of safety valve (or equivalent: for instance high pressure alarm)	X						
					X		
• Water level inside the drum of each boiler	L	R					
	H						X (1)
	HH			X			
	LL			X			
(1) Stop of the feed water pump							

Table 6 : Evaporators

Symbol convention H = High, HH = High high, G = group alarm L = Low, LL = Low low, I = individual alarm X = function is required, R = remote (AUT-CCS only)	Monitoring		Automatic control				
			Evaporator			Auxiliary	
Identification of system parameter	Alarm	Indication	Slow-down	Shut-down	Control	Standby Start	Stop
Electric fault at pump	X						
Heating fluid pressure or flow	L						
Excessive salinity of distilled water before drain valve or re-circulation valve					X (1)		
Excessive salinity of distilled water after drain valve or re-circulation valve (at tank inlet)	H						
(1) Automatic draining to bilge or re-circulation							

### 4.6 Electrical propulsion plant

#### 4.6.1 Documents to be submitted

The following additional documents are to be submitted to the Society:

- a list of the alarms and shutdowns of the electrical propulsion system
- when the control and monitoring system of the propulsion plant is computer based, a functional diagram of the interface between the programmable logic controller and computer network.

#### 4.6.2 Alarm system

The following requirements are applicable to the alarm system of electrical propulsion:

- alarms circuits of electrical propulsion are to be connected to the main alarm system on board. As an alternative, the relevant circuit may be connected to a local alarm unit. In any case, a connection between the local alarm unit and the main alarm system is to be provided
- the alarms can be arranged in groups, and shown in the control station. This is acceptable when a discrimination is possible locally
- when the control system uses a computer based system, the requirements of Pt C, Ch 3, Sec 3 are applicable, in particular, for the data transmission link between the alarm system and the control system
- individual alarms are considered as critical and are to be individually activated at the control stations, and acknowledged individually
- shutdown activation is to be considered as an individual alarm.

**Table 7 : Propulsion gas turbine**

Symbol convention H = High, HH = High high, G = group alarm L = Low, LL = Low low, I = individual alarm X = function is required, R = remote (AUT-CCS only)	Monitoring		Automatic control				
			Turbine			Auxiliary	
Identification of system parameter	Alarm	Indication	Slow-down	Shut-down	Control	Standby Start	Stop
<b>Lubricating oil system</b>							
• Turbine supply pressure	L		X			X	
	LL			X			
• Differential pressure across lubricating oil filter	H						
• Bearing or lubricating oil (discharge) temperature	H						
<b>Mechanical monitoring of gas turbine</b>							
• Speed		R			X		
	H			X			
• Vibration	H						
	HH			X			
• Rotor axial displacement (not applicable to roller bearing)	H						
	HH			X			
• Number of cycles performed by rotating parts	H						
<b>Gas generator monitoring system</b>							
• Flame and ignition failure				X			
• Fuel oil supply pressure	L						
• Fuel oil supply temperature	H + L						
					X		
• Cooling medium temperature	H						
• Exhaust gas temperature or gas temperature in specific locations of flow gas path (alarm before shutdown)	H						
	HH			X			
• Pressure at compressor inlet (alarm before shutdown)	L						
<b>Miscellaneous</b>							
• Control system failure	X						
• Automatic starting failure	X						

### 4.6.3 Safety functions

The following requirements are applicable to the safety system of electrical propulsion:

- as a general rule, safety stop using external sensors such as temperature, pressure overspeed, main cooling failure, stop of converter running by blocking impulse is to be confirmed by the automatic opening of the main circuit using a separate circuit
- in order to avoid accidental stop of the propulsion line and limit the risk of blackout due to wire break, the tripping of the main circuit-breaker is to be activated by an emission coil with a monitoring of the line wire break
- in the case of a single line propulsion system, the power limitation order is to be duplicated
- as a general rule, when the safety stop is activated, it is to be maintained until local acknowledgement.

### 4.6.4 Transformers

For transformers, parameters according to Tab 8 are to be controlled or monitored.

### 4.6.5 Converters

For converters, parameters according to Tab 9, Tab 10 and Tab 11 are to be monitored or controlled.

### 4.6.6 Smoothing coil

For the converter reactor, parameters according to Tab 12 are to be monitored or controlled.

### 4.6.7 Propulsion electric motor

For propulsion electric motors, parameters according to Tab 13 are to be monitored or controlled.

**4.6.8** All parameters listed in the tables of this item are considered as a minimum requirement for unattended machinery spaces.

Some group alarms may be locally detailed on the corresponding unit (for instance loss of electronic supply, failure of electronic control unit, etc.).

## 4.7 Shafting, clutches, CPP, gears

**4.7.1** For shafting and clutches, parameters according to Tab 14 are to be monitored or controlled.

**4.7.2** For controllable pitch propellers, parameters according to Tab 15 are to be monitored or controlled.

**4.7.3** For reduction gears and reversing gears, parameters according to Tab 16 are to be monitored or controlled.

**Table 8 : Transformers**

Symbol convention H = High, HH = High high, G = group alarm L = Low, LL = Low low, I = individual alarm X = function is required, R = remote (AUT-CCS only)	Monitoring		Automatic control				
			Motor			Auxiliary	
Identification of system parameter	Alarm	Indication	Slow-down	Shut-down	Control	Standby Start	Stop
Earth failure on main propulsion circuits	I						
Circuit-breaker, short-circuit	I (2)			X			
Circuit-breaker, overload	I (2)			X			
Circuit-breaker, undervoltage	I (2)			X			
Temperature of winding on phase 1, 2, 3 (1) (4)	G,I, H		X (3)				
	G,I, HH			X			
Temperature sensor failure (short-circuit, open circuit, supply failure)	G						
Cooling pump pressure or flow	G, L		X				
						X	
Cooling medium temperature	G, H		X				
Leak of cooling medium	G		X				
<p>(1) A minimum of 6 temperature sensors are to be provided:</p> <ul style="list-style-type: none"> <li>• 3 temperature sensors to be connected to the alarm system (can also be used for the redundant tripping of the main circuit-breaker)</li> <li>• 3 temperature sensors connected to the control unit.</li> </ul> <p>(2) To be kept in the memory until local acknowledgement.</p> <p>(3) Possible override of slowdown by the operator.</p> <p>(4) Not applicable to oil immersed type transformers. Those transformers are to be fitted with alarms and protections specified in Pt C, Ch 2, Sec 13, [4.1.1].</p>							

Table 9 : Network converter

Symbol convention H = High, HH = High high, G = group alarm L = Low, LL = Low low, I = individual alarm X = function is required, R = remote (AUT-CCS only)	Monitoring		Automatic control				
			Motor			Auxiliary	
Identification of system parameter	Alarm	Indication	Slow-down	Shut-down	Control	Standby Start	Stop
Short-circuit current I max	I			X			
Overvoltage	G			X			
Undervoltage	G						
Phase unbalanced	I			(X) (1)			
Power limitation activated	I						
Protection of filter circuit trip	I						
Circuit-breaker opening operation failure	I						
Communication circuit, control circuits, power supplies, watchdog of control system according to supplier's design	G			X			

(1) This parameter, when indicated in brackets, is only advisable according to the supplier's requirements.

Table 10 : Motor converter

Symbol convention H = High, HH = High high, G = group alarm L = Low, LL = Low low, I = individual alarm X = function is required, R = remote (AUT-CCS only)	Monitoring		Automatic control				
			Motor			Auxiliary	
Identification of system parameter	Alarm	Indication	Slow-down	Shut-down	Control	Standby Start	Stop
Short-circuit current I max	I			X			
Overvoltage	G			X			
Undervoltage	G			X			
Phase unbalanced	I						
Protection of filter circuit trip	I						
Communication circuit, control circuits, power supplies, watchdog of control system according to supplier's design	G			X			
Speed sensor system failure	G					X (1)	
Overspeed	I			X			
Braking resistor temperature (where applicable)	I, H						

(1) Automatic switch-over to the redundant speed sensor system.

Table 11 : Converter cooling circuit

Symbol convention H = High, HH = High high, G = group alarm L = Low, LL = Low low, I = individual alarm X = function is required, R = remote (AUT-CCS only)	Monitoring		Automatic control				
			Motor			Auxiliary	
Identification of system parameter	Alarm	Indication	Slow-down	Shut-down	Control	Standby Start	Stop
Air cooling temperature high	I	R					
Ventilation, fan failure	G		X				
Cooling pump pressure or flow low	G	R				X	
Cooling fluid temperature high	G						
Leak of cooling medium	G		X				
Temperature sensor failure (short-circuit, open circuit, supply failure)	G						



Table 12 : Smoothing coil

Symbol convention H = High, HH = High high, G = group alarm L = Low, LL = Low low, I = individual alarm X = function is required, R = remote (AUT-CCS only)	Monitoring		Automatic control				
			Motor			Auxiliary	
Identification of system parameter	Alarm	Indication	Slow-down	Shut-down	Control	Standby Start	Stop
Temperature of coil	I, H	R					
	I, HH						
Air cooling temperature	I, H						
Ventilation fan failure	G						
			X				
Cooling pump pressure or flow low	G	R					
						X	
Cooling fluid temperature high	G						
Leak of cooling medium	G						
			X				
Temperature sensor failure (short-circuit, open circuit, supply failure)	G						

Table 13 : Propulsion electric motor

Symbol convention H = High, HH = High high, G = group alarm L = Low, LL = Low low, I = individual alarm X = function is required, R = remote (AUT-CCS only)	Monitoring		Automatic control				
			Motor			Auxiliary	
Identification of system parameter	Alarm (1)	Indication	Slow-down	Shut-down	Control	Standby Start	Stop
Automatic tripping of overload and short-circuit protection on excitation circuit	G, H			X			
Loss of excitation	G			X			
Winding current unbalanced	G						
Harmonic filter supply failure	I						
Interface failure with power management system	I		X				
Earthing failure on stator winding and stator supply	I	R					
Temperature of winding on phase 1, 2, 3	I, H		X				
	I, HH			X			
Motor cooling air temperature	I, H	R					
Cooling pump pressure or flow	G, L	R	X				
						X	
Cooling fluid temperature	G, H						
Leak of cooling medium	G		X				
Temperature sensor failure (short-circuit, open circuit, supply failure)	G						
Motor bearing temperature	G, H	R					
Bearing lubrication oil pressure (for self-lubricated motor, when the speed is under the minimum RPM specified by the manufacturer, shutdown is to be activated)	I, L	R	X				
						X	
Turning gear engaged	I						
Brake and key engaged	I						
(1) Where alarm is associated to slowdown or shutdown, this alarm is to anticipate the action of shutdown and slowdown (pre-alarm).							

**Table 14 : Shafting and clutches of propulsion machinery**

Symbol convention H = High, HH = High high, G = group alarm L = Low, LL = Low low, I = individual alarm X = function is required, R = remote (AUT-CCS only)	Monitoring		Automatic control				
			Main Engine			Auxiliary	
Identification of system parameter	Alarm	Indication	Slow-down	Shut-down	Control	Standby Start	Stop
Temperature of each shaft thrust bearing (not applicable for ball or roller bearings)	H		X				
Stern tube bush oil gravity tank level	L						
Clutch oil temperature (if applicable)	H		X				
Clutch oil tank level (if applicable)	L						

**Table 15 : Controllable pitch propeller**

Symbol convention H = High, HH = High high, G = group alarm L = Low, LL = Low low, I = individual alarm X = function is required, R = remote (AUT-CCS only)	Monitoring		Automatic control				
			Main Engine			Auxiliary	
Identification of system parameter	Alarm	Indication	Slow-down	Shut-down	Control	Standby Start	Stop
Control oil temperature before cooler	H						
Oil tank level	L						

**Table 16 : Reduction gears/reversing gears**

Symbol convention H = High, HH = High high, G = group alarm L = Low, LL = Low low, I = individual alarm X = function is required, R = remote (AUT-CCS only)	Monitoring		Automatic control				
			Main Engine			Auxiliary	
Identification of system parameter	Alarm	Indication	Slow-down	Shut-down	Control	Standby Start	Stop
Lubricating oil temperature at the oil cooler outlet	H	R (1)	X				
Lubricating oil pressure	L (1)	R				X	
	LL			X			
Oil tank level (2)	L	R					

(1) May be omitted in the case of restricted navigation notation.  
 (2) May be omitted when the small size of the gearbox makes it unpracticable (low pressure alarm to be representative of a low level in the gearbox casing).

**4.8 Auxiliary system**

**4.8.1** Where standby machines are required for other auxiliary machinery essential to propulsion, automatic change-over devices shall be provided.

Change-over restart is to be provided for the following systems:

- cylinder, piston and fuel valve cooling
- cylinder cooling of diesel generating sets (where the circuit is common to several sets)

- main engine fuel supply
- diesel generating sets fuel supply (where the circuit is common to several sets)
- sea water cooling for propulsion plant
- sea water to main condenser (main turbines)
- hydraulic control of clutch, CPP or main thrust unit
- thermal fluid systems (thermal fluid heaters).

**4.8.2** When a standby machine is automatically started, an alarm is to be activated.

**4.8.3** When the propulsion plant is divided into two or more separate units, the automatic standby auxiliary may be omitted, when the sub-units concerned are fully separated with regard to power supply, cooling system, lubricating system etc.

Some of the propulsive plants may be partially used for reasons of economy (use of one shaft line or one propulsion engine for instance). If so, automatic change-over, necessary for this exploitation mode, is to be provided.

**4.8.4** Means shall be provided to keep the starting air pressure at the required level where internal combustion engines are used for main propulsion.

**4.8.5** Where daily service fuel oil tanks are filled automatically, or by remote control, means shall be provided to prevent overflow spillages.

**4.8.6** Arrangements are to be provided to prevent overflow spillages coming from equipment treating flammable liquids.

**4.8.7** Where daily service fuel oil tanks or settling tanks are fitted with heating arrangements, a high temperature alarm shall be provided if the flashpoint of the fuel oil can be exceeded.

**4.8.8** For auxiliary systems, the following parameters, according to Tab 17 to Tab 27 are to be monitored or controlled.

#### 4.9 Control of electrical installation

**4.9.1** Following a blackout, automatic connection of a standby generating set is to be followed by an automatic restart of the essential electrical services. If necessary, time delay sequential steps are to be provided to allow satisfactory operation.

In case of failure of the emergency generator, manual restart of a main generating set is admitted. Refer to Pt C, Ch 2, Sec 3, [2.3.9].

**4.9.2** Monitored parameters for which alarms are required to identify machinery faults and associated safeguards are listed in Tab 28 and Tab 29. These alarms are to be indicated at the control location for machinery as individual alarms; where the alarm panel with all individual alarms is installed on the engine or in the vicinity, a common alarm in the control location for machinery is required. For communication of alarms from the machinery space to the bridge area and accommodation for engineering personnel, detailed requirements are contained in [5].

**Table 17 : Control and monitoring of auxiliary electrical systems**

Symbol convention H = High, HH = High high, G = group alarm L = Low, LL = Low low, I = individual alarm X = function is required, R = remote (AUT-CCS only)	Monitoring		Automatic control				
			Main Engine			Auxiliary	
Identification of system parameter	Alarm	Indication	Slow-down	Shut-down	Control	Standby Start	Stop
Electric circuit, blackout	X						
Power supply failure of control, alarm and safety system	X						
Harmonic filter (when provided) (1)	Electrical protection (each phase)	X					
	Unbalance current	X					
(1) Not required for harmonic filters installed for single application frequency drives such as pump motors.							

**Table 18 : Incinerators**

Symbol convention H = High, HH = High high, G = group alarm L = Low, LL = Low low, I = individual alarm X = function is required, R = remote (AUT-CCS only)	Monitoring		Automatic control				
			Incinerator			Auxiliary	
Identification of system parameter	Alarm	Indication	Slow-down	Shut-down	Control	Standby Start	Stop
Combustion air pressure	L			X			
Flame failure	X			X			
Furnace temperature	H			X			
Exhaust gas temperature	H						
Fuel oil pressure (2)	L						
Fuel oil temperature or viscosity (1)	H + L						
(1) Where heavy fuel is used.							
(2) Where pressure is important for the combustion or a pump is not an integral part of the burner.							

Table 19 : Auxiliary boilers

Symbol convention H = High, HH = High high, G = group alarm L = Low, LL = Low low, I = individual alarm X = function is required, R = remote (AUT-CCS only)	Monitoring		Automatic control				
			Boiler			Auxiliary	
Identification of system parameter	Alarm	Indication	Slow-down	Shut-down	Control	Standby Start	Stop
Water level					X		
	L + H			X			
Fuel oil temperature or viscosity (3)	H + L						
Flame failure	X						
				X			
Combustion air supply fan low pressure				X			
Temperature in boiler casing (fire)	H						
Steam pressure					X		
	H (1)			X			
Steam temperature				X (2)			
(1) When the automatic control does not cover the entire load range from zero load.							
(2) For superheated steam over 330°C.							
(3) Where heavy fuel is used.							

Table 20 : Fuel oil system

Symbol convention H = High, HH = High high, G = group alarm L = Low, LL = Low low, I = individual alarm X = function is required, R = remote (AUT-CCS only)	Monitoring		Automatic control				
			System			Auxiliary	
Identification of system parameter	Alarm	Indication	Slow-down	Shut-down	Control	Standby Start	Stop
Fuel oil in daily service tank level	L						
Fuel oil daily service tank temperature (3)	H				X		
Fuel oil in daily service tank level	H (1)						
Fuel oil overflow tank level	H						
Air pipe water trap level on fuel oil tanks	H (2)						
Heater outlet fuel oil temperature					X		
	H (4)			X (5)			
Sludge tank level	H						
Fuel oil settling tank level	H (1)						
Fuel oil settling tank temperature (3)	H				X		
Fuel oil centrifugal purifier overflow	H			X (6)			
(1) To be provided if no suitable overflow arrangement							
(2) Or alternative arrangement as per Pt C, Ch 1, Sec 10, [9.1.7]							
(3) Applicable where heating arrangements are provided.							
(4) Or low flow alarm in addition to temperature control when heated by steam or other media.							
(5) Cut off of electrical power supply when electrically heated.							
(6) Shutdown of the fuel oil supply.							

Table 21 : Lubricating oil system

Symbol convention H = High, HH = High high, G = group alarm L = Low, LL = Low low, I = individual alarm X = function is required, R = remote (AUT-CCS only)	Monitoring		Automatic control				
			System			Auxiliary	
Identification of system parameter	Alarm	Indication	Slow-down	Shut-down	Control	Standby Start	Stop
Air pipe water trap level of lubricating oil tank See Pt C, Ch 1, Sec 10, [9.1.7]	H						
Sludge tank level	H						
Lubricating oil centrifugal purifier overflow	H			X (1)			
(1) Shutdown of the lubricating oil supply.							

Table 22 : Thermal oil system

Symbol convention H = High, HH = High high, G = group alarm L = Low, LL = Low low, I = individual alarm X = function is required, R = remote (AUT-CCS only)	Monitoring		Automatic control				
			System			Auxiliary	
Identification of system parameter	Alarm	Indication	Slow-down	Shut-down	Control	Standby Start	Stop
Thermal fluid temperature heater outlet	H						
	HH			X (1)			
Thermal fluid pressure pump discharge (4)	H			X			
Thermal fluid flow through heating element	L					X	
	LL			X (1)			
Expansion tank level	L						
	LL			X (2)			
Expansion tank temperature	H						
Combustion air pressure	L			X			
Fuel oil pressure	L						
Fuel oil temperature or viscosity (3)	H + L						
Burner flame failure	X			X			
Flue gas temperature heater outlet	H						
	HH			X (2)			
(1) Shut-off of heat input only. (2) Shut-off of heat input and delayed stop of fluid flow. (3) Where heavy fuel is used. (4) Not applicable to centrifugal pumps.							

Table 23 : Hydraulic oil system

Symbol convention H = High, HH = High high, G = group alarm L = Low, LL = Low low, I = individual alarm X = function is required, R = remote (AUT-CCS only)	Monitoring		Automatic control				
			System			Auxiliary	
Identification of system parameter	Alarm	Indication	Slow-down	Shut-down	Control	Standby Start	Stop
Pump pressure	H						
Service tank level	L						X (1)
(1) The automatic stop of the hydraulic pumps is to be operated in the same circumstances, except where this stop can lead to propulsion stop.							

**Table 24 : Boiler feed and condensate system for main and auxiliary boiler**

Symbol convention H = High, HH = High high, G = group alarm L = Low, LL = Low low, I = individual alarm X = function is required, R = remote (AUT-CCS only)	Monitoring		Automatic control				
			System			Auxiliary	
Identification of system parameter	Alarm	Indication	Slow-down	Shut-down	Control	Standby Start	Stop
Sea water flow in condenser or equivalent	L					X	
Vacuum in condenser (2)	L						
	LL			X			
Water level in main condenser (unless justified)	H + L						
					X		
	HH			X			
Salinity of condensate	H						
Feed water pump delivery pressure	L					X	
Feed water tank level	L						
Deaerator inside temperature or pressure (2)	L + H (1)						
Water level in deaerator (2)	L + H						
Extraction pump pressure (2)	L						
Drain tank level	L + H						
(1) In the case of forced circulation boiler.							
(2) When installed.							

**Table 25 : Compressed air system**

Symbol convention H = High, HH = High high, G = group alarm L = Low, LL = Low low, I = individual alarm X = function is required, R = remote (AUT-CCS only)	Monitoring		Automatic control				
			System			Auxiliary	
Identification of system parameter	Alarm	Indication	Slow-down	Shut-down	Control	Standby Start	Stop
Air temperature at compressor outlet	H						
Compressor lubricating oil pressure (except where splash lubrication)	LL			X			
Control air pressure (3)	L	R					
					X		
Starting air pressure before main shut-off valve	L (2)	local + R (1)					
					X		
	X					X	
Safety air pressure (3)	L						
					X		
(1) Remote indication is required if starting of air compressor is remote controlled, from wheelhouse for example.							
(2) For starting air, the alarm minimum pressure set point is to be so adjusted as to enable at least four starts for reversible propulsion engines and two starts for non-reversible propulsion engines.							
(3) When supplied through reducing valve, see Pt C, Ch 1, Sec 10, [2.5.4].							

**Table 26 : Cooling system**

Symbol convention H = High, HH = High high, G = group alarm L = Low, LL = Low low, I = individual alarm X = function is required, R = remote (AUT-CCS only)	Monitoring		Automatic control				
			System			Auxiliary	
Identification of system parameter	Alarm	Indication	Slow-down	Shut-down	Control	Standby Start	Stop
Sea water pump pressure or flow	X					X	
	L						
Fresh water pump pressure or flow	X					X	
	L						
Level in cooling water expansion tank	L						

Table 27 : Thrusters

Symbol convention H = High, HH = High high, G = group alarm L = Low, LL = Low low, I = individual alarm X = function is required, R = remote (AUT-CCS only)	Monitoring		Automatic control				
			Thruster			Auxiliary	
Identification of system parameter	Alarm	Indication	Slow-down	Shut-down	Control	Standby Start	Stop
Control oil temperature (preferably before cooler)	H						
Oil tank level	L						

Table 28 : Auxiliary trunk-piston reciprocating I.C. engines driving generators

Symbol convention H = High, HH = High high, G = group alarm L = Low, LL = Low low, I = individual alarm X = function is required, R = remote (AUT-CCS only)	Monitoring		Automatic control				
			Engine			Auxiliary	
Identification of system parameter	Alarm	Indication	Slow-down	Shut-down	Control	Standby Start	Stop
Fuel oil viscosity or temperature before injection (for engine running on heavy fuel)	L + H	local			X		
Fuel oil pressure		local					
Common rail fuel oil pressure	L						
Fuel oil leakage from high pressure pipes	H						
Lubricating oil temperature	H						
Lubricating oil pressure	L	local				X (4)	
	LL			X			
Activation of oil mist detection arrangements (1) (5) (7)	X			X			
Crankcase oil mist detector failure	X						
Exhaust gas temperature after each cylinder (2)	H	R	X				
Turbocharger lubricating oil inlet pressure (2) (3)	L	local					
Common rail servo oil pressure	L						
Pressure or flow of cooling system, if not connected to main system	L	local					
Temperature of cooling medium	H	local					
Level in cooling water expansion tank, if not connected to main system	L						
Engine speed		local					
					X		
	H			X			
Speed of turbocharger (6)	H						
Fault in the electronic governor system	X						
<p>(1) For engines having a power of more than 2250 kW or a cylinder bore of more than 300 mm.</p> <p>(2) For engine power &gt; 500 kW/cyl.</p> <p>(3) If without integrated self contained oil lubricating system.</p> <p>(4) When a stand by pump is required.</p> <p>(5) For each engine one oil mist detector (or engine bearing temperature monitoring system or equivalent device) having two independent outputs for initiating the alarm and shut-down would satisfy the requirement for independence between alarm and shut-down systems.</p> <p>(6) Only required for turbochargers of Categories B and C as defined in Pt C, Ch 1, Sec 14, [1.1.3].</p> <p>(7) Activation of oil mist detection arrangements is equivalent to activation of the temperature monitoring systems, or equivalent devices, of:</p> <ul style="list-style-type: none"> <li>the engine main and crank bearing oil outlet; or</li> <li>the engine main and crank bearing</li> </ul> <p><b>Note 1:</b> When the emergency generator is used in port, this Table applies.</p> <p><b>Note 2:</b> For engine driving emergency generator, see Pt C, Ch 1, Sec 2, Tab 7.</p>							

Table 29 : Auxiliary steam turbines

Symbol convention H = High, HH = High high, G = group alarm L = Low, LL = Low low, I = individual alarm X = function is required, R = remote (AUT-CCS only)	Monitoring		Automatic control				
			Turbine			Auxiliary	
Identification of system parameter	Alarm	Indication	Slow-down	Shut-down	Control	Standby Start	Stop
Turbine speed		local					
					X		
	HH			X			
Lubricating oil supply pressure	L					X	
	LL			X			

## 5 Alarm system

### 5.1 General

**5.1.1** A system of alarm displays is to be provided which readily allows identification of faults in the machinery and satisfactory supervision of related equipment. This may be arranged at a main control station or, alternatively, at subsidiary control stations. In the latter case, a master alarm display is to be provided at the main control station showing which of the subsidiary control stations is indicating a fault condition.

**5.1.2** Unless otherwise justified, separation of monitoring and control systems is to be provided.

**5.1.3** The alarm system is to be designed to function independently of control and safety systems, so that a failure or malfunction of these systems will not prevent the alarm system from operating. Common sensors for alarms and automatic slowdown functions are acceptable as specified in each specific table.

**5.1.4** *The alarm system shall be continuously powered and shall have an automatic change-over to a standby power supply in the case of loss of normal power supply.*

### 5.2 Alarm system design

**5.2.1** The alarm system and associated sensors are to be capable of being tested during normal machinery operation.

**5.2.2** Insulation faults on any circuit of the alarm system are to generate an alarm, when an insulated earth distribution system is used.

**5.2.3** An engineers' alarm is to be activated when the machinery alarm has not been accepted in the machinery spaces or control room within 5 minutes.

**5.2.4** The alarm system is to have a connection to the engineers' public rooms and to each of the engineers' cabins through a selector switch, to ensure connection to at least one of those cabins.

### 5.3 Machinery alarm system

**5.3.1** The local silencing of the alarms on the bridge or in accommodation spaces is not to stop the audible machinery space alarm.

**5.3.2** Machinery faults are to be indicated at the control locations for machinery.

### 5.4 Alarm system on navigating bridge

**5.4.1** Alarms associated with faults requiring speed reduction or automatic shutdown are to be separately identified on the bridge.

**5.4.2** The alarm system is to activate an audible and visual alarm on the navigation bridge for any situation which requires action by or the attention of the officer on watch.

**5.4.3** Individual alarms are to be provided at the navigation bridge indicating any power supply failures of the remote control of propulsion machinery.

## 6 Safety systems

### 6.1 General

**6.1.1** Safety systems of different units of the machinery plant are to be independent. Failure in the safety system of one part of the plant is not to interfere with the operation of the safety system in another part of the plant.

**6.1.2** In order to avoid undesirable interruption in the operation of machinery, the system is to intervene sequentially after the operation of the alarm system by:

- starting of standby units
- load reduction or shutdown, such that the least drastic action is taken first.

**6.1.3** The arrangement for overriding the shutdown of the main propelling machinery is to be such as to preclude inadvertent operation.

**6.1.4** After stoppage of the propulsion engine by a safety shutdown device, the restart is only to be carried out, unless otherwise justified, after setting the propulsion bridge control level on "stop".



## 7 Testing

### 7.1 General

**7.1.1** Tests of automated installations are to be carried out according to Pt C, Ch 3, Sec 6 to determine their operating conditions. The details of these tests are defined, in each case, after having studied the concept of the automated installations and their construction. A complete test program is to be submitted for approval.

**7.1.2** The tests of equipment carried out alongside the quay under normal conditions of use include, for instance:

- the electrical power generating set
- the auxiliary steam generator
- the automatic bilge draining system
- automatic centrifugal separators or similar purifying apparatus
- automatic change-over of service auxiliaries
- detection of high pressure fuel leaks from diesel generating sets or from flexible boiler burner pipes.

**7.1.3** Sea trials are used to demonstrate the proper operation of the automated machinery and systems. For this purpose, for instance, the following tests are to be carried out:

- Test of the remote control of propulsion:
  - checking of the operation of the automatic control system: programmed or unprogrammed starting speed increase, reversal, adjusting of the propeller pitch, failure of supply sources, etc.
  - checking of the crash astern sequence, to ensure that the reversal sequence is properly performed from full away, the ship sailing at its normal operation speed. The purpose of this check is not to control the nautical performances of the ship (such as stopping distance, etc.)
  - finally, checking of the operation of the whole installation in normal working conditions, i.e. as a general rule without watch-keeping personnel for the monitoring and/or running of the machinery during 6 h at least
  - The following procedure may, for instance, be chosen: "underway" at the ship's rated power during 3 h, then decreasing to "full ahead". Staying in that position during 5 min. Then stopping for 15 min. Then, putting the control lever in the following positions, staying 2 minutes in each one: astern slow, astern half, astern full, full ahead, half ahead, stop, full astern, stop, ahead dead slow, half ahead, then increasing the power until "underway" position.

- Test of the operating conditions of the electrical production:
  - automatic starting of the generating set in the event of a blackout
  - automatic restarting of auxiliaries in the event of a blackout
  - load-shedding in the event of generating set overload
  - automatic starting of a generating set in the event of generating set overload.
- Test of fire and flooding system:
  - Test of normal operation of the fire detection system (detection, system faults)
  - Test of detection in the scavenging air belt and boiler air duct
  - Test of the fire detection system as per [3.2.16]
  - Test of protection against flooding.
- Test of operating conditions, including manoeuvring, of the whole machinery in an unattended situation for 6 h.

### 7.2 Specific requirement for ships fitted with engine using both low-flashpoint gaseous fuels and fuel oil as fuel

**7.2.1** For ships assigned with **LNGfuel dualfuel**, **CNGfuel dualfuel**, **LPGfuel dualfuel** or, as relevant, other additional service features defined in Pt A, Ch 1, Sec 2 [4.13], the sea trials are to include additional tests to demonstrate the following capabilities in gas fuel mode:

- a) engine starting in gas fuel mode
- b) switchover from oil fuel mode to gas fuel mode and vice versa at different loads
- c) blackout test (when the dual fuel engine drives a generator), in order to check:
  - the automatic starting and connecting of stand-by generator(s)
  - the satisfactory operation of the tank pressure and temperature control system
  - the satisfactory operation of gas fuel handling and supply systems
- d) checking of the crash astern sequence (when the dual fuel engine is used as a propulsion engine).

**7.2.2** The proper operation of the automated machinery and systems is to be demonstrated in both oil fuel mode and gas fuel mode. The tests defined in [7.1.3] are to be carried during a period of at least 6 h in oil fuel mode and during an additional period of at least 4 h in gas mode.

## SECTION 2 CENTRALISED CONTROL STATION (AUT-CCS)

### 1 General

#### 1.1 Application

**1.1.1** The additional class notation **AUT-CCS** is assigned in accordance with Pt A, Ch 1, Sec 2, [6.4.3] to ships fitted with a machinery installation operated and monitored from a centralised control station, and complying with the requirements of this Section.

It applies to ships which are intended to be operated with machinery spaces unattended, but with continuous supervision from a position where control and monitoring devices of machinery are centralised.

Note 1: Machinery spaces are defined in Pt C, Ch 4, Sec 1, [3.24.1].

**1.1.2** Remote indications for continuous supervision of the machinery are to be located in a centralised control position, to allow a watch service of the machinery space.

**1.1.3** The provisions of Ch 3, Sec 1, [1.1.3] and Ch 3, Sec 1, [1.1.4] are also applicable for the additional class notation **AUT-CCS**.

#### 1.2 Exemptions

**1.2.1** Exemptions mentioned in Ch 3, Sec 1, [1.2] may also be considered for the notation **CCS**.

#### 1.3 Communication system

**1.3.1** A means of communication is to be provided between the centralised control station, the navigation bridge, the engineers' accommodation and, where necessary, the machinery spaces.

**1.3.2** The requirements mentioned in Ch 3, Sec 1, [1.3] are applicable.

### 2 Documentation

#### 2.1 Documents to be submitted

**2.1.1** In addition to those mentioned in Pt C, Ch 3, Sec 1, Tab 1, documents according to Tab 1 are required.

**Table 1 : Documentation to be submitted**

No	I/A (1)	Document
1	A	Means of communication diagram
2	A	Central control position layout and location
3	A	System of protection against flooding
(1) A: to be submitted for approval I: to be submitted for information.		

### 3 Fire and flooding precautions

#### 3.1 General

**3.1.1** The requirements mentioned in Ch 3, Sec 1, [3] are applicable, except for Ch 3, Sec 1, [3.4.4].

The calculation of the time it takes to reach the sea valves required under Ch 3, Sec 1, [3.4.3] should be determined based on the distance between the centralised control station and the platform from where the valves are manually operated.

**3.1.2** The fire detection and flooding alarms are to be transmitted to the centralised control position.

### 4 Control of machinery

#### 4.1 Propulsion plant operation

**4.1.1** The centralised control position is to be designed, equipped and installed so that the machinery operation is as safe and effective as if it were under direct supervision.

**4.1.2** Monitoring and control of main systems are to be designed according to the requirements mentioned in Ch 3, Sec 1, [4]. Additional indications, as alarms and measured values, in the centralised control position are required, and shown in the table with the symbol R.

**4.1.3** In the centralised control position, it is to be possible to restore the normal electrical power supply in the case of power failure (e.g. with remote control of the generating sets), unless an automatic restart is provided.

**4.1.4** Automatic restart of essential auxiliaries for propulsion and steering may be replaced by remote control from the centralised control position.

**4.1.5** The status of machinery (in operation or on standby) and all parameters crucial to the safe operation of essential machinery are to be shown at the centralised control position.

**4.1.6** Under all sailing conditions including manoeuvring, the speed, direction of thrust and, if applicable, the pitch of the propeller are also to be fully controllable from the centralised control position.

**4.1.7** In addition to the requirements in Ch 3, Sec 1, [4.1.10], the device to prevent overload, when automatic or remote controlled from the centralised control position, is to be fitted with an alarm indicating the necessity of slowing down.

## 4.2 Control position location

**4.2.1** The centralised control position is to be located in the machinery space or adjacent to it. Other arrangements are to be submitted to the satisfaction of the Society.

**4.2.2** If the centralised control position is an enclosed space located in the machinery spaces, it is to be provided with two safe fire escapes.

## 5 Alarm system

### 5.1 General

**5.1.1** Every alarm is to be indicated visually and audibly at the centralised control position.

**5.1.2** Requirements mentioned in Ch 3, Sec 1, [5] are applicable except Ch 3, Sec 1, [5.2.4].

## 6 Safety system

### 6.1 General

**6.1.1** Safeguard disactivation, if provided at the centralised control position, is to be so arranged so that it cannot be operated accidentally; the indication «safety devices off» is to be clearly visible. This device is not to disactivate the overspeed protection.

**6.1.2** Safety systems provided with automatic operation may be replaced by remote manual operation from the centralised control position.

## 7 Testing

### 7.1 Tests after completion

**7.1.1** Tests are to be carried out of all systems which are required to be in operation at the quay, such as the fuel oil purifier system, electrical power generation, auxiliary steam generator, etc.

### 7.2 Sea trials

**7.2.1** The sea trials are to demonstrate the proper operation of automation systems. A detailed test program is to be submitted for approval. As a minimum, the following are to be tested:

- the remote control system of propulsion machinery
- electrical production and distribution
- efficiency of the fire detection and fire alarm system
- protection against flooding
- continuous operation in all sailing conditions, including manoeuvring, for 6 hours with unattended machinery spaces and at least one person in CCS.

## SECTION 3

## AUTOMATED OPERATION IN PORT (AUT-PORT)

### 1 General

#### 1.1 Application

**1.1.1** The additional class notation **AUT-PORT** is assigned in accordance with Pt A, Ch 1, Sec 2, [6.4.4] to ships fitted with automated installations enabling the ship's operation in port or at anchor without personnel specially assigned for the watch-keeping of the machinery in service, and complying with the requirements of this Section.

**1.1.2** The arrangements provided are to be such as to ensure that the safety of the ship in port is equivalent to that of a ship having the machinery spaces manned.

**1.1.3** The provisions of Ch 3, Sec 1, [1.1.3] and Ch 3, Sec 1, [1.1.4] are also applicable for the additional class notation **AUT-PORT**.

#### 1.2 Exemptions

**1.2.1** Exemptions mentioned in Ch 3, Sec 1, [1.2] may also be considered for the notation **AUT-PORT**.

**1.2.2** Ship whose gross tonnage is less than 1600 and fishing ships of less than 75 metres in length are exempted from the requirements in [3.1.2].

**1.2.3** Fishing vessels of less than 45 metres in length are exempted from the requirements in [3.1.2] insofar as the location of the spaces considered allows people on board to easily detect fire outbreaks.

#### 1.3 Communication system

**1.3.1** The requirements of Ch 3, Sec 1, [1.3] are applicable.

### 2 Documentation

#### 2.1 Documents to be submitted

**2.1.1** In addition to the those mentioned in Pt C, Ch 3, Sec 1, Tab 1, documents according to Tab 1 are required.

### 3 Fire and flooding precautions

#### 3.1 general

**3.1.1** The requirements given in Ch 3, Sec 1, [3] are applicable unless otherwise indicated below.

**Table 1 : Documentation to be submitted**

No	I/A (1)	Document
1	A	Means of communication diagram
2	A	Technical description of automatic engineers' alarm and connection of alarms to accommodation and bridge, when applicable
3	A	System of protection against flooding
4	I	List of machinery to be in operation in port
(1) A: to be submitted for approval I: to be submitted for information.		

**3.1.2** The remote control of the main fire pump for the pressurisation of the fire main may be located at the bridge running station if the wheelhouse and officers' cabins are close together. Failing this, such remote control is to be fitted at a place close to the officers' cabins or to the engine room exit. Alternatively, the fire main may be permanently under pressure.

**3.1.3** Transmission to the navigating bridge of fire alarm and flooding is not required, but these alarms are to be directed at the intervention personnel.

**3.1.4** Automatic fire detection is to be fitted at the navigation bridge if unmanned during ship's operation in port.

### 4 Control of machinery

#### 4.1 Plant operation

**4.1.1** The machinery and systems which are to be in operation in port are to be designed according to Ch 3, Sec 1, [4], unless otherwise stated.

**4.1.2** The requirements regarding electrical production for propulsion Ch 3, Sec 1 are not applicable.

**4.1.3** The operation of auxiliaries, other than those associated with propulsion, is to be designed according to Ch 3, Sec 1.

### 5 Alarm system

#### 5.1 General

**5.1.1** The alarm system is to be designed according to Ch 3, Sec 1, [5], unless otherwise stated in this Section.

**5.1.2** The alarm system is to be designed so as to inform of any situation which requires attention of the personnel on watch.

For this purpose, an audible and visual alarm is to be activated in the centralised control station, in the engineers' public rooms and at each engineer's cabin through a selector switch. Any other arrangement is to be to the satisfaction of the Society.

## **6 Testing**

### **6.1 Tests after completion**

**6.1.1** Tests are to be carried out of all systems which are required to be in operation in port, such as: the fuel oil purifier system, electrical power generation, auxiliary steam generator, etc.

## SECTION 4 INTEGRATED MACHINERY SPACES (AUT-IMS)

### 1 General

#### 1.1 Application

**1.1.1** The additional class notation **AUT-IMS** is assigned in accordance with Pt A, Ch 1, Sec 2, [6.4.5] to ships fitted with automated installations enabling periodically unattended operation of machinery spaces and additionally provided with an integrated computer based system for the control and monitoring of machinery.

This notation is assigned when the requirements of this Section are complied with in addition to those of Ch 3, Sec 1 for the assignment of the notation **AUT-UMS**.

**1.1.2** The design of automation systems including computer based systems is to be such that functionality of all services remains available when a single failure occurs.

**1.1.3** The notation **-HWIL** is added to the additional class notation **AUT-IMS** when the control system has been verified according to the requirements of NR632 Hardware-in-the-loop Testing.

### 2 Documentation

#### 2.1 Documents to be submitted

**2.1.1** In addition to the those mentioned in Pt C, Ch 3, Sec 1, Tab 1 and Ch 3, Sec 1, Tab 1, documents listed in Tab 1 are to be submitted.

**Table 1 : Documents to be submitted**

No	I/A (1)	Document
1	I	Block diagram of the integrated computer based systems
2	I	Description of the data transmission protocol
3	I	Description of the auto-diagnosis function
4	I	Failure Mode and Effect Analysis describing the effects of failures on the integrated computer based system used for the control and monitoring of machinery.
(1) A: to be submitted for approval I: to be submitted for information.		

### 3 Fire and flooding precautions

#### 3.1 Fire prevention

**3.1.1** The height of oil-tight coamings of boiler gutterways is to be designed in accordance with Pt C, Ch 1, Sec 10, [5.10.4]. Other gutterways are to have a coaming height not

less than 150 mm. Their drain inlet is to be fitted with suitable protection such as a grid or small welded rods. Drain pipes are to be sufficiently large and free from sharp bends or horizontal or rising portions.

The height of gutterway coamings around the fuel oil components of diesel engines (injection pumps, filters, etc.) may, due to their small dimensions, be reduced to 75 mm.

On small diesel engines, when construction of such gutterways around the aforesaid devices is difficult, a gutterway of 150 mm height around the considered engine is acceptable.

**3.1.2** The fastening of connections (nuts, screw, etc.) of lubricating oil or fuel oil pipes above 1,8 bar pressure is to be locked.

**3.1.3** In addition to the requirements of Ch 3, Sec 1, [3.1], lubricating oil and fuel oil tanks are to be provided with a high level alarm.

#### 3.2 Fire detection

**3.2.1** In addition to that required in Ch 3, Sec 1, [3.2], fire detection is also to be provided in rooms containing oil hydraulic equipment, operated without watch-keeping personnel, and adjacent to such rooms or to those listed in Ch 3, Sec 1, [3.2].

**3.2.2** Fire detection is to be able to detect either smoke or combustion gas.

**3.2.3** Each detector is to be provided with a clear indicator showing that it is activated by a fire. A repeater of this indicator is required for detectors situated in spaces which are not easily accessible or can be locked, such as fuel or oil purifier rooms, workshops, stores, etc.

Repeaters may be omitted for fixed fire detection and fire alarm system with remotely and individually identifiable fire detectors (i.e. addressable fire detectors).

#### 3.3 Fire fighting

**3.3.1** Some of the portable and mobile extinguishers required are to be located in the following places:

- close to the engine room entrances
- close to the engine control room.

**3.3.2** The emergency stop of machinery space ventilation is to be possible from the navigating bridge or in proximity.

**3.3.3** Where some remote safety action is possible from the wheelhouse on thermal fluid heaters or incinerators, the alarm grouping is to enable the operator to avoid any confusion when initiating such action.

### 3.4 Protection against flooding

**3.4.1** An alarm is to be given on the navigating bridge in the event of flooding in machinery spaces situated below the load line. This alarm is to be separated from the others, individual for each machinery space and triggered early, at flooding outset.

## 4 Integrated computer based systems

### 4.1 General

**4.1.1** The following requirements apply in addition to those in Pt C, Ch 3, Sec 3 and Ch 3, Sec 1.

**4.1.2** Integrated computer based system used for the control and monitoring of services essential for the propulsion and safety of the ship (e.g. propulsion, electricity production) is to be fault tolerant.

**4.1.3** A Failure Mode and Effects Analysis (FMEA) is to be carried out in accordance with IEC Publication 60812 or any other recognised standard in order to demonstrate that control and monitoring functions remain available in the event of a single failure of the integrated computer based system.

Note 1: Requirements given in Ch 2, App 1 may be used for guidance.

Note 2: Normally, no consideration is given to defects occurring simultaneously; however in the case of defects which would remain undetected, it might be necessary to take into consideration the adding of several independent defects.

### 4.2 Design requirements

**4.2.1** Necessary arrangements are to be made to avoid interaction between the various automatic control circuits in the event of a fault in one of them (e.g. galvanic separation of automatic control electric circuits or earth leak monitoring device with possibility of disconnecting the faulty circuit, keeping the others in service); this applies in particular to the propulsion plant of steam vessels.

**4.2.2** The machinery computer network is to allow communication between subsystems to an extent acceptable for this network. The subsystems interconnected on the network are as follows:

- automation systems for control of machinery according to the requirements of Ch 3, Sec 1, [4], and
- automation systems for dynamic positioning when applicable.

**4.2.3** The machinery computer network is not to be used for non-essential functions. A separate network is to be provided for these non-essential functions, where necessary.

**4.2.4** In addition to the requirements of Pt C, Ch 3, Sec 3, [6], the machinery computer network is to be redundant and, in the case of failure of one network, automatic switching to the other network is to be provided.

**4.2.5** The integrated automation system is to be designed such that the subsystem is still operating in the case of loss of transmission of the network.

**4.2.6** In the case of failure of one workstation, the corresponding functions are to be possible from any other station, without a stop of the system in operation. Particular attention is to be paid to the configuration of the workstations.

## 5 Construction requirements

### 5.1 Electrical and electronic construction requirements

**5.1.1** In order to resist vibrations, connections are to be made carefully, for instance by using terminals crimped on the insulated conductor, or by means of heat shrinkable sleeves, etc.

**5.1.2** Direct soldered connections on printed cards are to be avoided. Fastening of the printed cards is to make their connectors free of mechanical stresses. Response to vibration of the printed cards and of their components is to be specially considered.

### 5.2 Pneumatic construction requirements

**5.2.1** Compressed air is to be supplied from two sources having sufficient flow rate to allow normal operation while one is out of service. The pressure is to be automatically maintained at a value allowing satisfactory operation of the installation.

**5.2.2** One or more air vessels fitted with non-return valves are to be provided and reserved for monitoring and control installations.

**5.2.3** If compressed air used for monitoring and control circuits is supplied by reducing valves, the latter are to be duplicated, together with their filters, unless an emergency air supply is provided.

**5.2.4** Necessary provision is to be made to ensure continuous and automatic cooling, filtering, dehydration and oil separation of the compressed air prior to its introduction into the monitoring and control circuits.

**5.2.5** When oiling of the air is necessary for the lubrication of some pneumatic components, it is to be done directly to the supply side of these components.

### 5.3 Hydraulic construction requirements

**5.3.1** At least two feed pumps are to be provided so that the pressure in circuits can be maintained while one of the pumps is out of service. Piping and accessories are to be so arranged that it is possible to carry out maintenance and repairs on one pump while the second remains in operation.

**5.3.2** The capacity of the tanks is to be sufficient to ensure:

- the maintenance of a suitable level in normal service and during stop periods
- the settling of impurities and the air-freeing of the liquid.

**5.3.3** The filling and return piping for these tanks is to be so arranged as to avoid any abnormal turbulence and excessive aeration of the liquid. The location of tanks and suction pipes is to ensure correct supply of the pumps.

**5.3.4** The hydraulic fluids are to have appropriate and constant characteristics for their use and particularly a satisfactory viscosity at all the temperatures at which they are to operate in normal service; their flashpoint and their temperature of self-ignition or of destruction by heat are to be the highest possible. The materials used for the various parts of the circuits are to be adapted to the nature and characteristics of the liquids employed.

**5.3.5** Transducers connecting pipes are to be so designed as to avoid any delay in the transmission of information, especially when viscous fluids are used.

**5.3.6** Air venting facilities are to be foreseen for the various circuits.

## 6 Control of machinery

### 6.1 General

**6.1.1** The necessary operations to pass from «manoeuvring» to «underway», and vice versa, are to be automated. This applies, for example, to the starting of auxiliary boilers or of diesel generating sets as well as to main engine fuel oil change-over when this change-over is necessary.

**6.1.2** When passing from «stand by» to «underway» and vice versa, the gradual process of power increase and decrease, if considered necessary by the builder, is to be automatic; nevertheless, when provided, this device is to be able to be quickly cancelled from the bridge, to perform emergency manoeuvring.

**6.1.3** The operations to be effected from the monitoring and control stations are to be defined with due consideration to the type of installations and to their automation level. Operating conditions are also to be considered during periods when machinery watch-keeping is ensured and during trouble periods, when intervention, or even watch-keeping, is foreseen.

**6.1.4** Where sufficiently centralised controls are situated near the various components of the plant to allow quick intervention by a reduced personnel, the above-mentioned monitoring and control station may be replaced by a simple monitoring station, providing information necessary for rapid and easy intervention.

**6.1.5** Where some indications are transmitted to a control station by means of fluids, necessary arrangements are to be made to avoid a leak from the piping having a detrimental effect on the operation of the surrounding equipment (circuits, terminals). In particular, the piping of liquid fluids is to be separated from electrical apparatuses and gutters are to be provided for draining leakage.

**6.1.6** Measuring instruments located on the navigating bridge are to be lighted or luminescent; it is to be possible to adjust their light intensity to protect the operator from dazzling. The number of dimmers is to be reduced as far as possible. Partial covers on lamps are to be avoided; an adjusting system by trimmer is to be preferred. It is not to be possible to hide or totally extinguish the luminous signals of alarms.

**6.1.7** Arrangements are to be made to allow the propulsion plant to be restarted from the navigating bridge after a blackout. Special attention is to be paid to certain operations such as:

- reset of the safety shutdown devices
- restart of disengageable main engines, or
- automatic firing of an auxiliary boiler.

An indication is to be shown on the navigating bridge as soon as propulsion can be restarted.

**6.1.8** Where control and monitoring are under the supervision of one watchkeeper only, his unavailability is to release an alarm at the bridge station.

### 6.2 Diesel propulsion plants

**6.2.1** The lubricating system for cylinder liners, when fitted, is to be equipped with an alarm device which operates in the event of failure of one of the distribution boxes. The monitoring is to be performed on at least two feed lines for each box and on at least one line per cylinder.

**6.2.2** Drainage of the under piston spaces of cross-head engines is to be carried out either continuously or automatically at regular intervals. The frequency of the operation is to be manually adjustable to take account of the operating conditions and of the engine condition (adjusting of cylinder lubrication, condition of piston rings, etc.); in this case, an alarm is to operate if drainage has not been effected in the allotted time.

**6.2.3** An alarm is to indicate any abnormal presence of water in the super-charging manifolds; in this case, unless otherwise justified, an automatic blocking of the engine start is also to be provided.

**6.2.4** In a manoeuvring condition, correct engine operation is to remain ensured automatically:

- where main engines are fed with heavy heated fuel oil in the "manoeuvring" condition, suitable arrangements are to be provided to enable long duration stops
- if particular arrangements are necessary, such as a change in injector cooling, they are to be automated.

**6.2.5** Unless justified by the Manufacturer, for remotely started engines, means are to be provided on the bridge for turning the main engine with compressed air after any intentional stop longer than 10 min. For this purpose a warning light, suitably labelled and automatically switched on, or any other equivalent arrangement, may be used.



This operation is to be possible only when the following conditions are fulfilled:

- shaft line brake released
- turning gear disengaged
- fuel pump rack at zero position
- bridge control system “on”.

In addition, means are to be provided at the control station in operation to check that the turning is correctly carried out.

The remote control of turning with air from the bridge is to be suppressible from the control station or the engine room.

**6.2.6** For each main engine, the bridge running station is to be provided with the following additional devices:

- one tachometer for disengageable engines
- a load indicator (fuel oil pump rack) or an overload alarm
- a signal “automatic starting valve manually closed”.

**6.2.7** The following additional alarms are to be provided:

- thermal engine overload (exhaust gas temperature)
- low temperature of cylinder and/or piston coolant (except where justified such as for sea water recirculation). Furthermore, the inlet and outlet valves of each cylinder are to be locked in the open position
- differential pressure through fuel oil filters
- high temperature of each reduction gear, reverse gear or clutch bearing.

### 6.3 Steam propulsion plants

**6.3.1** In addition to the requirements stated in [6.1.7], special attention is to be paid to certain operations such as:

- reset of the safety shutdown devices
- restart of disengageable main engines, or
- automatic firing of a main or auxiliary boiler.

On board steam ships, automatic re-firing of at least one main boiler is to be provided.

**6.3.2** In addition to that required in Ch 3, Sec 1, [4.3], the power reduction is to be carried out also in case of fire in exhaust gas boilers provided with finned tubes.

**6.3.3** In the event of a lack of energy supply, the dead position of the control components (valves, actuators, etc.) is to lead to as safe a situation as possible. This relates in particular to the following components:

- control valve of level in the steam drum
- control valve of desuperheating by water injection
- control valve of fuel supply (position reducing the combustion rate to a safe value, whatever the steam demand may be. Such a fault is as a general rule not to give rise to the complete fuel shut-off, especially in the case of ships having a single main boiler)
- intake vanes of forced draught fan (as a general rule open; in such case and consequently, adjustment of the air flow is to follow the fuel rate fluctuations and not vice versa).

**6.3.4** Special arrangements are to be made to avoid accidental tripping of the water level safety monitoring devices, due for instance to ship motions. If the action of such devices has been time delayed, justification of the time value is to be given to the Society.

**6.3.5** An automatic monitoring device is to shut off immediately the fuel feeding in the case of non-detection of the corresponding flame: arrangements are to be made to prevent this device from being influenced by the radiation emitted by the other burners.

Automatic flame monitoring devices are to be so designed and constructed as to ensure satisfactory safety: any defect of such devices is to have an active character and lead to an alarm, as well as the extinguishing of the burner concerned.

Flame control sensors are to be suitably protected against thermal effects which would be harmful as well as against soot deposits.

Fuel shut-off to a burner through a safety monitoring device may be followed by an automatic firing attempt, provided that all precautions are taken to ensure the safety of the operation. No second attempt is allowed without manual local action.

An automatic flame monitoring system is to be in operation while burners are automatically operated. However, the flame monitoring may be overridden to allow burner light up, soot blowing and manual combustion control. During the automatic firing period, monitoring disactivation is to be automatic: duration of disactivation is to be set to the minimum compatible with sure light up and in all cases is to be inferior to a period of time  $t$ , in seconds, given by the formula:

$$t = 151 \times 10^6 / P_{ci} \times Q$$

$P_{ci}$  : Lower calorific value, in J

$Q$  : Flow provided for light up of first burner in automatic mode, in kg/h.

If necessary, permanent auxiliary burners may be used; such burners are to be provided with their own flame monitoring devices.

**6.3.6** Following a blackout, the automatic re-firing of at least one main boiler is to be provided. The sequential re-firing is to be possible only if there is a non-dangerous situation. Firing of the first burner is to be automatically prepared by an air pre-purge sequence of the furnace and uptakes. A pre-purge sequence is only allowed to take place when fluid pressure before the last valve is cancelled or greatly reduced. The duration of this sequence is to enable the delivery of a volume of air of more than 3 times the combustion chamber and uptake volume. During this sequence, burner air registers and dampers which may be located in the gas path are to be wide open and forced draught fans are to be settled at a speed sufficient to ensure good scavenging. The number of burners fired automatically is to allow normal speeds and notably «full astern». Firing of burners by proximity may be accepted subject to justification and satisfactory tests. In the event of unsatisfactory tests (flame in bad position, limited explosion, etc.), one igniter for each burner may be required.

**6.3.7** Arrangements are to be made so that in the event of «crash astern» the boiler is able to automatically supply all the necessary output; the burner control system is to be particularly considered for this purpose.

**6.3.8** It is to be possible to individually control each burner from a monitoring station situated in the engine room. Adjusting of the combustion rate is to be carried out automatically. Light up or extinguishing of burners, when necessary, is to be done without intervention of the personnel. According to their type, automatic draining of burners during shut-off may be required. Closing of a burner register is as a rule, except during its firing period, to give rise to the shut-off of its own fuel supply. When a boiler is shut down (safety shutdown action, remote action, during pre-purge before firing, after a blackout, etc.), fuel pressure before the terminal shut-off device of burner(s) is to be automatically deactivated or greatly reduced by appropriate means.

**6.3.9** Steps are to be taken to avoid and detect any pollution of condensed water returns from heating steam circuits by hydrocarbons. For instance, hydrocarbons can be automatically monitored before entering the drain tank.

**6.3.10** Where carried out by an automatic device, soot blowing is to be preceded by a warning and draining of the piping. If necessary, steps are to be taken to prevent detrimental conditions being induced in the boiler operation by cleaning actions. All blowers are to be locally operable.

**6.3.11** Permanent recording of the following parameters is to be provided:

- drum water level (for each boiler)
- burner supply pressure
- burner air flow or pressure
- superheated steam pressure and temperature.

Furthermore, the additional arrangements listed in Tab 2 are to be provided.

**Table 2 : Main boilers**

Symbol convention H = High, HH = High high, G = group alarm L = Low, LL = Low low, I = individual alarm X = function is required, R = remote	Monitoring		Automatic control				
			Main boiler			Auxiliary	
Identification of system parameter	Alarm	Indication	Slow-down	Shut-down	Control	Standby Start	Stop
Feed water turbo pump automatic shutdown	X						
Presence of water in fuel oil, except where arrangement is such (volume contained below suction pipe) that draining once a day gives sufficient safety	X						
Pressure drop through filters	L						
Combustible gas pressure	H			X (1)			
Combustible gas temperature	H + L			X (1)			
Combustible gas uptake fan stop	X			X (1)			
Gas detection in the uptakes	X			X (1)			
Smoke opacity of combustion gas	H						
Superheated steam pressure	L		X (2)				
Soot blowing automatic sequence fault	X						
Steam heating drain oil pollution	X						
Pressure drop through de-oiler	X						
Fire in air heater (where heat exchanger is provided from smoke to air)	X	local					
Rotative air heater fire	X						
Rotative air heater rotation stop	X						
Rotative air heater bearing and thrust bearing temperatures	H						
Rotative air heater motor drive	X						
Forced draught fan lubricating oil pressure	L		X				
Forced draught fan overspeed (turbo only)	X						
Forced draught fan plain bearings temperature	H						
(1) Automatic shut-off of the burner line.							
(2) Shutdown of the large consumers which are not essential to propulsion, such as cargo or ballast turbo pump, etc.							

**6.3.12** Maintaining of a sufficient vacuum is to be ensured even in the event of crash astern or during long full astern manoeuvre.

**6.3.13** To prevent shutdown in the case of vacuum loss when in full astern during an excessive period, the setting point of the vacuum fault alarm is to be adjusted to give sufficient time for the possible necessary precautions to be taken (slowdown). This alarm is to involve automatic slowdown or is to indicate clearly in the wheelhouse the necessity to slow down.

**6.3.14** The functions and equipment listed below are the subject of a particular examination, in order to determine the arrangements, alarms and safeguards to be provided:

- automated steam bypass to the condenser
- H.P. bled steam circuits (in order to avoid possible water return into the H.P. turbine in the event of malfunctions)
- water drains from which there is a risk of pollution by sea water.

**6.3.15** During automatic spinning, when the steam pressure of the turbines reaches a preset value stated by the builder, without having caused the line shafting to turn, a safety device is to shut down the manoeuvring gear. At every control position a separate audible and visible signal is to precede spinning in sufficient time to allow the cycle to be stopped if necessary.

**6.3.16** The propeller r.p.m control device is to moderate the variation rate of steam input pressure, in correct and safe relation to the turbine and boiler capability.

**6.3.17** When manoeuvring, correct plant operation is to be ensured automatically. For this purpose, some operations are to be automated. This applies, in particular, to the following:

- manoeuvring of the astern stop valve

- opening and closing of the main turbine and manifold drain valves
- operation of the automatic spinning sequence.

**6.3.18** The operations necessary to pass from “manoeuvre” to “underway” and vice versa are to be automated. This applies in particular to the following:

- bleed steam circuits
- steam bypass valves to the turbines
- additional valves
- circulation of sea water by scoop or by pump
- steam bypass to main condenser.

**6.3.19** Additional requirements for steam turbine propulsion plants are given in Tab 3.

## 6.4 Gas turbine propulsion plant

**6.4.1** Additional requirements for gas turbine propulsion plants are given in Tab 4.

**6.4.2** Normal operation of the turbine is to include regular rinsing of the combustion air circuit.

## 6.5 Electric propulsion plant

**6.5.1** Additional requirements for the electric propulsion plant are listed in Ch 3, Sec 1, [4.6].

## 6.6 Shafting, clutches, CPP, gears

**6.6.1** The temperature of each shaft bearing fitted between the main engine (or the reduction gear) and the sterntube is to be monitored (alternatively, a group alarm associated with means to detect the fault is acceptable). This monitoring is not required for ball or roller bearings.

**Table 3 : Main turbines**

Symbol convention H = High, HH = High high, G = group alarm L = Low, LL = Low low, I = individual alarm X = function is required, R = remote	Monitoring		Automatic control				
			Main turbine			Auxiliary	
Identification of system parameter	Alarm	Indication	Slow-down	Shut-down	Control	Standby Start	Stop
Pressure drop through lubricating oil filter	H						
Water in lubricating oil of reduction gear return tank, or level in lubricating oil of reduction gear return tank (when dehydrator is provided)	H						
Main condenser flooding				X (1)			
Auxiliary condenser sea water flow or equivalent	L						
Auxiliary condenser delivery pressure, or flow, of condensate pump	L						
Exhaust steam manifold to atmosphere or equivalent (high pressure)	X						

(1) When axial condenser.

Table 4 : Gas turbine propulsion plants

Symbol convention H = High, HH = High high, G = group alarm L = Low, LL = Low low, I = individual alarm X = function is required, R = remote	Monitoring		Automatic control				
			Main Turbine			Auxiliary	
Identification of system parameter	Alarm	Indication	Slow-down	Shut-down	Control	Standby Start	Stop
Metal particle detection in lubricating oil	X						
Lubricating oil temperature inlet to turbine	H						
Lubricating oil tank level	L						
Metal particle detection in fuel oil	X						
Fuel oil deaerator efficiency	X						

Table 5 : Auxiliary boilers

Symbol convention H = High, HH = High high, G = group alarm L = Low, LL = Low low, I = individual alarm X = function is required, R = remote	Monitoring		Automatic control				
			Boiler			Auxiliary	
Identification of system parameter	Alarm	Indication	Slow-down	Shut-down	Control	Standby Start	Stop
Water level	H			X (1)			
Oil pollution in the steam heating drains	X						
Circulating pump delivery pressure or flow	L			X (1)			
Steam pressure	L						
Fuel oil pressure	L						
Misfire	X						
(1) Automatic fuel shut-off.							

## 6.7 Auxiliary systems

**6.7.1** Low pressure in air vessels is to trigger an alarm.

**6.7.2** If the production of auxiliary steam is necessary for the proper operation of the installations covered by the notation, and if it is dependent on the propulsion plant power, its continuity is to be ensured in case of change in propulsion power.

**6.7.3** Oil fired automated auxiliary boilers necessary for propulsion (for instance necessary to fuel heating supplying the main engine) are to be fitted with continuous or on/off automatic combustion control. Furthermore, automatic firing of at least one of these boilers is to be provided after blackout.

**6.7.4** Package burner units, which could cause serious fires where they break their fastening or in the event of accidental or inadvertent removal from the boiler, with the possibility of automatic firing in that position, are to be provided with appropriate safety devices, such as:

- additional mechanical support of heavy units
- micro switch included in the firing sequence, or equivalent.

**6.7.5** Where a burner is switched off, fuel pressure before the last valve is to be automatically suppressed or notably reduced by an arrangement provided for this purpose.

**6.7.6** The additional arrangements listed in Tab 5 are to be provided. However, they are not compulsory for auxiliary boilers used for cargo or accommodation heating only.

**6.7.7** Fire in an exhaust gas finned tube boiler (exhaust gas manifold high temperature) is to trigger an alarm.

**6.7.8** Any risk of introducing a heated product into a stopped oil circuit is to be prevented by appropriate means (pressurisation with nitrogen, compressed air, etc.). The additional arrangements listed in Tab 6 are to be provided.

**6.7.9** The detection system for possible oil leakage into the boiler furnace is not to introduce any risk of fire extension (in particular in connecting to the atmosphere). In addition, the oil coming from a safety valve discharge is to be suitably collected.

**6.7.10** Thermal fluid heaters heated by main engine exhaust gas are to be specially examined by the Society. Taking into account the risk inherent in this type of equipment, particular arrangements or protection may be required.

**6.7.11** Incinerators for chemical products are specially examined.

Table 6 : Thermal fluid heaters

Symbol convention H = High, HH = High high, G = group alarm L = Low, LL = Low low, I = individual alarm X = function is required, R = remote	Monitoring		Automatic control				
			System			Auxiliary	
Identification of system parameter	Alarm	Indication	Slow-down	Shut-down	Control	Standby Start	Stop
Thermal fluid leak into furnace	X			X (1)			
Fault in pressurisation system	X						
Critical fire in boiler	X			X			
(1) Automatic fuel shut-off and shutdown of the circulation.							

Table 7 : Evaporators

Symbol convention H = High, HH = High high, G = group alarm L = Low, LL = Low low, I = individual alarm X = function is required, R = remote	Monitoring		Automatic control				
			Evaporator			Auxiliary	
Identification of system parameter	Alarm	Indication	Slow-down	Shut-down	Control	Standby Start	Stop
Electric fault at pump	X						
Heating fluid pressure or flow	L						
Excessive salinity of distilled water	H				X (1)		
(1) Automatic draining to bilge or re-circulation							

**6.7.12** Installation of fuel oil blending units is to be submitted to the examination of the Society.

**6.7.13** An alarm is to be triggered when the blending unit outflow is too low.

**6.7.14** Unexpected modifications of the blend ratio are to be detected through an appropriate device. This monitoring, fitted at the blending unit heater outlet, is as a general rule to be effected:

- by supervision of the high and low temperature when heating adjustment is carried out through a viscosimeter
- by viscosity supervising, when heating adjustment is carried out by a thermostatic device.

**6.7.15** Precautions are to be taken in order to prevent malfunction of the propulsion plant and electric power plant in case of blending unit failure (automatic change-over to light fuel oil for instance).

**6.7.16** Where necessary, steps are to be taken to reduce or suppress blend heating when the heavy fuel rate is too low.

**6.7.17** As a general rule, the homogeneity of the blend is to be ensured; this may involve a special arrangement, more particularly when tanks are provided between the blending unit and booster pumps.

**6.7.18** Other evaporators than those associated to propulsion are to be provided with the arrangements listed in Tab 7.

## 6.8 Control of electrical installation

**6.8.1** Where the electrical power is exclusively produced by diesel generator sets, the oil quantity in the crankcase (volume contained between the maximum and minimum levels indicated by the engine builder) is to allow continuous service of 24 h at full load with 2,5 g/kW/h oil consumption. Alternatively, automatic lubricating oil make up to the crankcase may be accepted.

**6.8.2** Where generators can be paralleled, installation is to include automatic start, synchronising, connecting and load sharing.

**6.8.3** Where the number of generators in service is to vary according to operating condition, starting and connecting of supplementary generators, entailed by the use of equipment during manoeuvring, is not to require intervention in machinery spaces.

**6.8.4** Where starting of the standby generating set mentioned in Pt C, Ch 2, Sec 3, [2.2] depends on emergency generating set running, precautions are to be taken to ensure automatic connecting of the latter. In particular, the following alarms are to be provided:

- preheating and pre-lubricating failure (except where the engine Manufacturer stipulates that these operations are not indispensable)
- starting air pressure low (or equivalent)
- fuel oil tank level low.

**6.8.5** The additional arrangements for electricity production listed in Tab 8 are to be provided.

Table 8 : Electricity production

Symbol convention H = High, HH = High high, G = group alarm L = Low, LL = Low low, I = individual alarm X = function is required, R = remote	Monitoring		Automatic control				
			Prime mover			Auxiliary	
Identification of system parameter	Alarm	Indication	Slow-down	Shut-down	Control	Standby Start	Stop
<b>Main diesel generator</b>							
Cylinder cooling general outlet temperature (where pre-heating is provided)	L						
Pre-lubrication failure, if applicable	X						
Crankcase or return tank level (when electrical production is only supplied by diesel generator sets)	L						
Fuel oil pressure	L						
Differential pressure through filters (when fuel oil pipeline is common to several diesel generators)	X						
Turning gear or bar engaged				X (1)			
Fault of primary cooling (when centralised)	X						
<b>Turbogenerator</b>							
Thrust and reduction gear bearing temperature	H						
<b>Generator</b>							
Sleeve bearing temperature	H						
Flow or pressure of coolant (when liquid cooled)	L						
Cooler inlet temperature (when liquid cooled)	H						
<b>Electric circuits</b>							
Insulation resistance of electrical supply to essential automatic control system and to essential propulsion auxiliaries	L						
Generator overload (110 % of rated current)	X		X (2)				
(1) Safety lock of automatic start.							
(2) Automatic load shedding.							

6.8.6 The requirements stated in Pt C, Ch 3, Sec 2, [8.4.1] and Ch 3, Sec 1, [4.8.1] apply also to the following:

- turbo feed pumps of main boilers
- fuel oil supply pump to main boilers
- rotative air heater motor drive
- turbo generator lubricating oil pump (if necessary)
- main condensate pump (main condenser)
- vacuum pump (where air ejectors are provided, the steam supply valves are to be physically locked)
- condensate pump (auxiliary condenser)
- cooling sea water pump to auxiliaries of turbines and gearing (where essential auxiliaries are cooled)
- hydraulic pump for remote control.

6.8.7 The automatic restart of essential electrical auxiliaries after blackout is to be as fast as practicable and, in any case, less than 5 minutes.

## 7 Testing

### 7.1 Additional testing

7.1.1 In addition to those required in Ch 3, Sec 1, the following additional tests are to be carried out at sea:

- checking of the proper operating condition of fire detection in economisers, exhaust gas boilers fitted with finned tubes, etc.
- checking of the proper operating condition of the integrated computer based systems used for monitoring, control and safety of machinery and in particular:
  - visual inspection
  - functional operation of workstation
  - transfer of control of workstation
  - inhibition function of alarms
  - alarm acknowledgement procedure
  - simulation of internal and external failure of the integrated system, including loss or variation of power supply
  - wrong data insertion test.

### 7.2 Maintenance equipment

7.2.1 For maintenance, at least the following equipment is to be supplied:

- equipment for testing pressure sensors
- equipment for testing temperature sensors
- testing equipment as described in Ch 3, Sec 1, [3.2.16] for fire detectors, comprising extension rods for quick and easy testing
- a portable tachometer, if necessary.

Part F  
**Additional Class Notations**

Chapter 4

---

**INTEGRATED SHIP SYSTEMS (SYS)**

**SECTION 1 CENTRALISED NAVIGATION EQUIPMENT (SYS-NEQ)**

**SECTION 2 INTEGRATED BRIDGE SYSTEMS (SYS-IBS)**

**SECTION 3 COMMUNICATION SYSTEM (SYS-COM)**





# SECTION 1 CENTRALISED NAVIGATION EQUIPMENT (SYS-NEQ)

## 1 General

### 1.1 Application

**1.1.1** The additional class notation **SYS-NEQ** is assigned, in accordance with Pt A, Ch 1, Sec 2, [6.5.2], to ships fitted with a centralised navigation control system so laid out and arranged that it enables normal navigation and manoeuvring operation of the ship by two persons in cooperation.

This notation is assigned when the requirements of Articles [1] to [5], [7] and [8] of this Section are complied with.

**1.1.2** The additional class notation **SYSNEQ-1** is assigned, in accordance with Pt A, Ch 1, Sec 2, [6.5.2], when, in addition to [1.1.1], the installation is so arranged that the navigation and manoeuvring of the ship can be operated under normal conditions by one person for periodical one man watches. This notation includes specific requirements for prevention of accidents caused by the operator's unfitness.

This notation is assigned when the requirements of this Section are complied with.

**1.1.3** The composition and the qualification of the personnel on watch remain the responsibility of the Owner and the Administration. The authorisation to operate the ship in such condition remains the responsibility of the Administration.

### 1.2 Operational assumptions

**1.2.1** The requirements are framed on the following assumptions:

- Plans for emergencies are specified and the conditions under which a one man watch is permitted are clearly defined in an operations manual which is acceptable to the Administration with which the ship is registered.
- The manning of the bridge watch is in accordance with the national regulations in the country of registration and for the waters in which the ship is operating.
- The requirements of the International Convention on Standards of Training Certification and Watchkeeping for seafarers (STCW) and other applicable statutory regulations are complied with.

### 1.3 Regulations, guidelines, standards

**1.3.1** The requirements are based on the understanding that the applicable regulations and guidelines issued by the International Maritime Organisation are complied with, in particular:

- a) Regulations 15 to 28, Chapter V of the 1974 "International Convention for the Safety of Life at Sea" (SOLAS) and applicable amendments
- b) The international Regulations for Preventing Collisions at Sea and all other relevant Regulations relating to Global Maritime Distress and Safety System (GMDSS) and Safety of Navigation required by Chapters IV and V of SOLAS 1974, as amended
- c) the Provisional Guidelines for the Conduct of Trials in which the Officer of the Navigational Watch acts as the sole Lookout in Periods of Darkness (MSC Circular 566 of 2 July 1991)
- d) IMO A.694: 1991, General requirements for shipborne radio equipment forming part of the global maritime distress and safety system (GMDSS) and for electronic navigational aids
- e) MSC Circular 982, Guidelines on ergonomic criteria for bridge equipment and layout
- f) Convention on the International Regulations for Preventing Collision at Sea, 1972 (COLREG)
- g) IMO Performance Standards for navigational equipment applicable to:
  - Magnetic compasses (Resolution A.382)
  - Gyrocompasses (Resolution A.424)
  - Performance standards for radar equipment (Resolution MSC.192(79))
  - Speed and distance measuring equipment (Resolution A.478, A.824, MSC.96 (72))
  - Echo sounding equipment (Resolution A.224, MSC.74 (69) Annex 4)
  - Electronic navigational aids – general requirements (Resolution A.574)
  - VHF Radio installation (Resolution MSC.68 (68) Annex 1, A.524 (13), A.803 (19))
  - Heading control systems (HCS) (Resolution A.342, MSC.64 (67) Annex 3)
  - Rate-of-turn indicators (Resolution A.526)
  - VHF watchkeeping receiver (Resolution A.803 (19), MSC.68 (68) Annex 1)
  - Performance standards for track control systems (Resolution MSC.74 (69) Annex 2)
  - Performance standards for marine transmitting heading devices (THDs) (Resolution MSC.116 (73))
  - Performance standards for electronic chart display and information systems (Resolution MSC.191 (79) , MSC.232 (82))
  - Maintenance of electronic chart display and information system (ECDIS) software (IMO circ.266)

- Performance standards for shipborne global positioning system receiver equipment (Resolution A.819 (19))
- Adoption of the revised performance standards for shipborne global positioning system (GPS) receiver equipment (Resolution MSC.112 (73))
- Adoption of the revised performance standards for shipborne GLONASS receiver equipment (Resolution MSC.113 (73))
- Adoption of the revised performance standards for shipborne DGPS and DGLONASS maritime radio beacon receiver equipment (Resolution MSC.114 (73)).
- Performance standards for a universal automatic identification system (AIS) (Resolution MSC.74 (69) Annex 3)
- Performance standards for an integrated navigation system (INS) (Resolution MSC.86 (70) Annex 3)
- Adoption of the revised performance standards for integrated, navigation systems (INS) (Resolution MSC.252 (83))
- Performance standards for sound reception systems (Resolution MSC.86 (70) Annex 1)
- Performance standards for the presentation of navigation-related information on shipborne navigational displays (Resolution MSC.191(79))
- Performance standards for a bridge navigational watch alarm system (BNWAS) (Resolution MSC.128(75))
- Performance standards for shipborne voyage data recorders (VDRs) (Resolution A.861(20) as amended by IMO Res. MSC.214(81))

**1.3.2** The requirements and guidelines of ISO 8468 – ed. 3 “Ship’s bridge layout and associated equipment– Requirements and guidelines” are applicable.

**1.3.3** Additional requirements may be imposed by the national authority with whom the ship is registered and/or by the Administration within whose territorial jurisdiction it is intended to operate.

## 1.4 Definitions

**1.4.1** Terms used in the requirements are defined below:

- Acquisition: the selection of those target ships requiring a tracking procedure and the initiation of their tracking
- Alarm: a visual and audible signal indicating an abnormal situation
- ARPA: automatic radar plotting aid
- Backup navigator: any individual, generally an officer, who has been designated by the ship’s Master to be on call if assistance is needed on the navigation bridge
- Bridge: that area from which the navigation and control of the ship is exercised, including the wheelhouse and bridge wings
- Bridge wings: those parts of the bridge on both sides of the ship’s wheelhouse which, in general, extend to the ship side

- CPA: closest point of approach, i.e. the shortest target ship-own ship calculated distance that will occur in the case of no change in course and speed data
- Conning position: the place in the wheelhouse with a commanding view and which is used by navigators when monitoring and directing the ship movements
- Display: means by which a device presents visual information to the navigator, including conventional instrumentation
- Ergonomics: application of the human factor in the analysis and design of equipment, work and working environment
- Field of vision: angular size of a scene that can be observed from a position on the ship’s bridge
- Lookout: activity carried out by sight and hearing as well as by all available means appropriate in the prevailing circumstances and conditions so as to make a full appraisal of the situation and of the risk of collision
- Navigation: all tasks relevant for deciding, executing and maintaining course and speed in relation to waters and traffic
- Navigator: person navigating, operating bridge equipment and manoeuvring the ship
- NAVTEX: an international maritime radio telex system sponsored by IMO and IHO, which automatically receives the broadcast telex information such as navigational, meteorological warnings and search and rescue (SAR) alerts on a 24-hour watch basis
- Normal conditions: when all systems and equipment related to navigation operate within design limits, and environmental conditions such as weather and traffic do not cause excessive workload to the officer of the watch
- Officer of watch: person responsible for safe navigating, operating of bridge equipment and manoeuvring of the ship
- Radar plotting: the whole process of target detection, tracking, calculation of parameters and display of information
- Seagoing ship: ship navigating on the high seas, i.e. areas along coasts and from coast to coast
- TCPA: time to closest point of approach
- Tracking: process of observing the sequential changes in the position of a target, to establish its motion
- Wheelhouse: enclosed area of the bridge
- Workstation: position at which one or several tasks constituting a particular activity are carried out.

## 2 Documentation

### 2.1 Documents to be submitted

**2.1.1** In addition to the documents mentioned in Pt C, Ch 3, Sec 1, Tab 1, and the requirement in Pt C, Ch 3, Sec 1, [2.1.1], documents according to Tab 1 are to be submitted.

**2.1.2** Additional plans and specifications are to be submitted for approval, if requested by the Society.

**Table 1 : Documentation to be submitted**

No.	I/A (1)	Documentation
1	A	General arrangement of bridge and wheelhouse showing the position of the control console and panels
2	A	Plans showing the field of vision from each workstation
3	A	List and specification of navigational equipment fitted on the bridge and references (Manufacturer, type, national authority approval...)
4	A	Functional block diagram indicating the relationship between the items of navigational equipment and between them and other equipment
5	A	List of alarms and instrumentation fitted on the bridge
6	A	Diagram of electrical supply to the navigational equipment
7	A	Diagram of the system linking the bridge alarms with the other operational locations (2)
8	A	Diagram of the communication systems
9	A	Diagram of the BNWAS
10	A	Test program including test method
11	I	List of the intended area of operation of the ship
<p>(1) A : to be submitted for approval I : to be submitted for information.</p> <p>(2) Documents to be submitted only when a SYSNEQ-1 notation is requested.</p>		

### 3 Bridge layout

#### 3.1 General

**3.1.1** The bridge configuration, the arrangement of consoles and equipment location are to enable the officer of the watch to perform navigational duties and other functions allocated to the bridge as well as maintain a proper lookout from a convenient position on the bridge, hereafter referred to as a 'workstation'.

**3.1.2** A workstation for navigation and traffic surveillance/manoeuvring is to be arranged to enable efficient operation by one person under normal operating conditions. All relevant instrumentation and controls are to be easily visible, audible and accessible from the workstation.

**3.1.3** The bridge layout design and workstations are to enable the ship to be navigated and manoeuvred safely by two navigators in cooperation.

**3.1.4** The requirements and guidelines of the ISO 8468 Standard are to be regarded as a basic reference for the design of bridge layout.

### 4 Bridge instrumentation and controls

#### 4.1 General

**4.1.1** The instrumentation and controls at the workstation for navigation and traffic surveillance/manoeuvring are to be arranged to enable the officer of the watch to:

- determine and plot the ship's position, course, track and speed

- analyse the traffic situation
- decide on collision avoidance manoeuvres
- alter course
- change speed
- effect internal and external communications related to navigation and manoeuvring, radio communication on the VHF
- give sound signals
- hear sound signals
- monitor course, speed, track, propeller revolutions (pitch), rudder angle and depth of water
- record navigational data (may be manually recorded from data available at the workstation).

**4.1.2** Irrespective of their size, gross tonnage and date of construction, all ships assigned the additional class notation **SYS-NEQ** are to be equipped with the instrumentation and controls described in [4.2] to [4.4] and as referred to in Tab 2.

#### 4.2 Safety of navigation: collision-grounding

**4.2.1** The ship is to be equipped with an RADAR/ARPA system meeting the requirements of IMO Resolution MSC.192(79)).

The categories of ship/craft with their radar performance requirements are specified in Tab 3.

**4.2.2** An heading control system (HCS) is to be provided and monitored by a heading alarm addressed to the navigator, in case of malfunction. This alarm is to be derived from a system independent from the automatic steering system. An overriding control device is to be provided at the navigating and manoeuvring workstation.

**Table 2 : List of mandatory equipment**

Equipment	Additional class notations	
	SYS-NEQ	SYS-NEQ 1
Multifunction displays - according to MSC.191(79)	optional	optional
Radar (1)	CAT 1(H)/2(H)/3(H)	CAT 1(H)
Gyrocompass	one	one
Magnetic compass	yes	yes
Spare magnetic compass or second gyrocompass fed by main and emergency power supply and in addition by a transitional power supply (e.g. battery)	yes	yes
Transmitting Heading Device (THD)	yes	yes
Heading Control System (HCS), formerly autopilot	yes	yes
ECDIS with backup	yes	yes
Position receiver (GNSS ...)	one	one
Bridge Navigation Watch Alarm System (BNWAS)	yes	yes
Alarm transfer system	–	yes, at least to master's cabin
Central alarm panel	–	yes
Echo sounder	yes	yes
Speed and Distance Measuring Equipment (SDME) (2)	yes	yes
Sound reception (if totally enclosed bridge)	yes	yes
VHF at conning position	one	one
NAVTEX	yes	yes
Weather chart facsimile	yes	yes
Wind speed and direction	yes	yes
AIS	yes	yes
VDR	yes	yes
(1) According to [4.2.1] H: when approached for high speed application		
(2) Speed of the ship through the water and over the ground		

**Table 3 : Categories of ship/craft with their radar performance requirements**

	Category of ship/craft		
	CAT 3	CAT 2	CAT 1
Size of ship/craft	<500 gt	500 gt to < 10000 gt and HSC < 10000 gt	all ships/craft ≥ 10000 gt
Minimum operational display area diameter	180 mm	250 mm	320 mm
Minimum display area	195 mm x 195 mm	270 mm x 270 mm	340 mm x 340 mm
Auto acquisition of targets	-	-	yes
Minimum acquired radar target capacity	20	30	40
Minimum activated AIS target capacity	20	30	40
Minimum sleeping AIS target capacity	100	150	200
Trial manoeuvre	-	-	yes

### 4.3 Position fixing

**4.3.1** Ships are to be provided with the following position systems:

- a) position fixing systems appropriate to the intended service areas
- b) at least two independent radar, one of which is to operate within the X-band
- c) a gyrocompass system
- d) a speed log system
- e) an echo sounding system.
- f) an ECDIS with backup arrangement.

### 4.4 Controls - Communication

**4.4.1** Ships are to be provided with the following control and communication:

- a) a propulsion plant remote control system, located on the bridge
- b) a whistle control device
- c) a window wipe and wash control device
- d) a main workstation console lighting control device
- e) steering pump selector/control switches
- f) an internal communication system
- g) a VHF radiotelephone installation
- h) a wheelhouse heating/cooling control device
- i) a NAVTEX automatic receiver and recorder.

Note 1: The systems or controls under a) to g) are to be fitted within the reach of the officer of the watch when seated or standing at the main navigating and manoeuvring workstation.

## 5 Design and reliability

### 5.1 General

**5.1.1** Where computerised equipment is interconnected through a computer network, failure of the network is not to prevent individual equipment from performing its individual functions.

### 5.2 Power supply

#### 5.2.1 Power supply for AC equipment

- a) Power to navigation equipment is to be supplied by two circuits, one fed directly from the main source of electrical power, and one fed directly from the emergency source of power. Power to radio equipment is also to be supplied by two circuits as described above and is additionally to be supplied by a reserve source of energy.
- b) The power supplies to the distribution panels are to be arranged with automatic change-over facilities between the two sources.
- c) The distribution of supplies to navigation equipment is to be independent of those for radio equipment. The circuits from the power sources is to be terminated either

in one or two distribution panels. When one distribution panel is used, the two circuits supplying power to the panel are to be provided with split feeds into two separate bus bars, one for the radio equipment and one for the navigation equipment. The panel(s) is(are) to be sited on the navigation bridge or other suitable position on the bridge deck.

- d) The circuits supplying the board(s) are, as far as practicable, to be separated from each other throughout their length. Facilities are to be provided in each distribution board for changing over between the main source of power and the emergency source of power. It is preferable that change over be initiated automatically. When a single distribution board is used for both radio and navigation equipment, separate change-over switches are to be provided for each service.
- e) Where radio equipment requires an uninterrupted input of information from the ship's navigational equipment or other equipment, it is necessary for the equipment providing the data to be supplied from the same distribution board bus serving the radio equipment rather than the bus bar serving the navigation equipment.
- f) Failure of any power supply to the panel is to initiate an audible and visual alarm at the navigation bridge.
- g) Each consumer is to be individually connected to the distribution panel bus bar and individually provided with short-circuit protection.
- h) An indicator is to be mounted in a suitable place to indicate when batteries of the reserve source of energy are being discharged.

#### 5.2.2 Power supply for DC equipment

- a) The requirements of [5.2.1] are applicable.
- b) Where the equipment is fed via converters, separate converters are to be provided and these are to be located on the supply side of change-over facility.
- c) The radio equipment and the navigation equipment are to be provided with separate converters.

#### 5.2.3 Power supply for equipment operated either AC or DC

- a) Each consumer is to be individually connected to the main source of electrical power and to a distribution bus bar of the panel which is fed from the emergency source of electrical power and also, in case of the radio equipment, from the reserve source of energy (radio batteries). These two circuits are to be separated throughout their length as far as practicable.
- b) The radio equipment and the navigation equipment are to be provided with separate converters.
- c) An indicator is to be mounted in a suitable place visible for responsible member of the crew to indicate when batteries of the reserve source of energy are being discharged.

**5.2.4** Following a loss of power which has lasted for 30 seconds or less, all primary functions are to be readily reinstated.

### 5.3 Environmental conditions

**5.3.1** Shipborne navigational equipment specified in IMO Publication 978-88-04E "PERFORMANCE STANDARDS FOR NAVIGATIONAL EQUIPMENT" is to be capable of continuous operation under the conditions of various sea states, vibration, humidity, temperature and electromagnetic interference likely to be experienced in the ship in which it is installed.

**5.3.2** Equipment which has been additionally specified in this notation is to comply with the environmental conditions specified in Pt C, Ch 2, Sec 2 for control and instrumentation equipment, computers and peripherals for shipboard use.

## 6 Prevention of accidents caused by operator's unfitness

### 6.1 Field of vision

**6.1.1** For the purpose of performing duties related to navigation, traffic surveillance and manoeuvring, the field of vision from a workstation is to be such as to enable observation of all objects which may affect the safe conning of the ship. The field of vision from a workstation is to be in accordance with the guidelines on navigation bridge visibility, as specified in IMO Resolution A.708, MSC Circular 982 and ISO 8468 ed.3 as it applies to new ships.

### 6.2 Alarm/warning transfer system - Communications

**6.2.1** Any alarm/warning that requires bridge operator response is to be automatically transferred to the Master and, if he deems it necessary, to the selected backup navigator and to the public rooms, if not acknowledged on the bridge within 30 seconds.

Such transfer is to be carried out through the systems required by [6.2.3] and [6.2.7], where applicable.

**6.2.2** Acknowledgement of alarms/warnings is only to be possible from the bridge.

**6.2.3** The alarm/warning transfer is to be operated through a fixed installation.

**6.2.4** Provision is to be made on the bridge for the operation of a navigation officer call-alarm to be clearly audible in the spaces of [6.2.1].

**6.2.5** The alarm transfer system is to be continuously powered and have an automatic change-over to a standby power supply in the case of loss of normal power supply.

**6.2.6** At all times, including during blackout, the officer of the watch is to have access to facilities enabling two-way speech communication with another qualified officer.

The bridge is to have priority over the communication system.

Note 1: The automatic telephone network is acceptable for this purpose, provided that it is automatically supplied during blackouts and that it is available in the locations specified in [6.2.1].

**6.2.7** If, depending on the shipboard work organisation, the backup navigator may attend locations not connected to the fixed installation(s) described in [6.2.1], he is to be provided with a portable wireless device enabling both the alarm/warning transfer and the two-way speech communication with the officer of the watch.

**6.2.8** External sound signals from ships and fog signals that are audible on open deck are also to be audible inside the wheelhouse; a transmitting device is to be provided to reproduce such signals inside the wheelhouse (recommended frequency range: 70 to 700 Hertz).

### 6.3 Bridge layout

**6.3.1** The bridge configuration, the arrangement of consoles and equipment location are to enable the officer of the watch to maintain a proper lookout from a convenient workstation.

**6.3.2** A workstation for navigation and traffic surveillance/manoeuvring is to be arranged to enable efficient operation by one person under normal operating conditions.

## 7 Ergonomical recommendations

### 7.1 Lighting

**7.1.1** The lighting required on the bridge should be designed so as not to impair the night vision of the officer on watch. Lighting used in areas and at items of equipment requiring illumination whilst the ship is navigating is to be such that night vision adaptation is not impaired, e.g. red lighting. Such lighting is to be arranged so that it cannot be mistaken for a navigation light by another ship. It is to be noted that red lighting is not to be fitted over chart tables so that possible confusion in colour discrimination is avoided.

### 7.2 Noise level

**7.2.1** The noise level on the bridge should not interfere with verbal communication and mask audible alarms.

### 7.3 Vibration level

**7.3.1** The vibration level on the bridge should not be uncomfortable to the bridge personnel.

### 7.4 Wheelhouse space heating/cooling

**7.4.1** Unless otherwise justified, wheelhouse spaces are to be provided with heating and air cooling systems. System controls are to be readily available for the officer of the watch.

## 7.5 Navigator's safety

**7.5.1** There are to be no sharp edges or protuberances on the surfaces of the instruments and equipment installed on the bridge which could cause injury to the navigator.

**7.5.2** Sufficient handrails or the equivalent are to be fitted inside the wheelhouse or around instruments and equipment therein for safety in bad weather.

**7.5.3** Adequate means are to be made for anti-slip of the floor, whether it is dry or wet.

**7.5.4** All wheelhouse doors are to be operable with one hand. Bridge wing doors are not to be self closing and means are to be provided to hold the doors in open position.

**7.5.5** Where provision for seating is made in the wheelhouse, means for securing are to be provided, having regard to storm conditions.

## 8 Testing

### 8.1 Tests

**8.1.1** Documentary evidence in the form of certification and/or test results is to be submitted to the satisfaction of the Society. Where acceptable evidence is not available, the requirements of Pt C, Ch 3, Sec 6 are applicable.

**8.1.2** Shipboard tests and sea trials are to be carried out in accordance with the test procedures submitted for approval in advance to the Society. Tests and trials are to be performed under the supervision of the Surveyors.

**8.1.3** After fitting on board, the installations are to be submitted to tests deemed necessary to demonstrate correct operation. Some tests may be carried out at quay side, while others are to be effected at sea trials.

## SECTION 2

## INTEGRATED BRIDGE SYSTEMS (SYS-IBS)

### 1 General

#### 1.1 Application

**1.1.1** The additional class notation **SYS-IBS** is assigned, in accordance with Pt A, Ch 1, Sec 2, [6.5.3], to ships fitted with an integrated bridge system which allows simplified and centralised bridge operation of the main functions of navigation, manoeuvring and communication, as well as monitoring from the bridge of other functions, as specified in [1.1.3].

This notation is assigned when the requirements of this Section, and the one specified in Ch 4, Sec 1, [1] to Ch 4, Sec 1, [5], Ch 4, Sec 1, [7] and Ch 4, Sec 1, [8] (**SYSNEQ** notation) are complied with.

**1.1.2** The additional class notation **SYS-IBS-1** is assigned, in accordance with Pt A, Ch 1, Sec 2, [6.5.3], to ships fitted with an integrated bridge system which allows simplified and centralised bridge operation of the main functions of navigation, manoeuvring and communication, as well as monitoring from the bridge of other functions, as specified in [1.1.3].

This notation is assigned when the requirements of this Section, and the one specified in Ch 4, Sec 1 (**SYSNEQ-1** notation) are complied with.

**1.1.3** The following functions are to be part of the additional class notation **SYS-IBS** and **SYS-IBS-1**:

- passage execution (according to Tab 1)
- route control and monitoring (according to Tab 1)
- control and monitoring of the machinery installation (according to Part C, Chapter 3 for **SYS-IBS** and according to Ch 3, Sec 1 for **SYS-IBS-1**).

In addition the following functions may be part of the additional class notation **SYS-IBS-1**:

- control communication system:
  - external communication linked with the safety of the ship (distress equipment)
  - internal communication system
- monitoring of specific cargo operations (loading and discharging of cargo, logging of cargo data, loading calculation)
- pollution monitoring
- monitoring of heating, ventilation and air conditioning for passenger ships.

**1.1.4** This document specifies the minimum requirements for the design, manufacture, integration and testing of integrated bridge systems. The latter are to comply with IMO Resolution MSC 64.(67) Annex 1 of the International Maritime Organisation (IMO), and other relevant IMO perfor-

mance standards, in order to meet the functional requirements contained in applicable IMO instruments, not precluding multiple usage of equipment and modules or the need for duplication.

**1.1.5** The notation presumes efficient ship management by suitably qualified personnel providing for, inter alia, the uninterrupted functional availability of systems and for human factors.

**1.1.6** The notation **-HWIL** is added to the additional class notation **SYS-IBS** or **SYS-IBS-1** when the control system has been verified according to the requirements of NR632 Hardware-in-the-loop Testing.

#### 1.2 Reference Regulations

##### 1.2.1 The following regulations are applicable:

- IEC 60945: 2002, Maritime navigation and radiocommunication equipment and systems - General requirements - Methods of testing and required test results
- IEC 61162 (all parts), Maritime navigation and radiocommunication equipment and systems - Digital interfaces
- ISO 8468 ed.3, Ship's bridge layout and associated equipment - requirements and guidelines
- ISO 9001: 1991, Quality systems - Model for quality assurance in design, development, production, installation and servicing
- ISO 9002: 1991, Quality systems - Model for quality assurance in production, installation and servicing
- IMO International Convention for the Safety of Life at Sea (SOLAS): 1974, as amended (last amendment)
- IMO A.1021(26) : 2009, Code on alerts and indicators
- IMO A.694: 1991, General requirements for shipborne radio equipment forming part of the global maritime distress and safety system (GMDSS) and for electronic navigational aids
- IMO SN.1/Circ.288: 2010, Guidelines for bridge equipment and systems, their arrangement and integration (BES)
- IMO MSC.192(79) : performance standards for radar equipment
- IMO MSC/Circular 566: 1991, Provisional guidelines on the conduct of trials in which the officer of the navigational watch acts as the sole lookout in periods of darkness
- IMO MSC.191(79): performance standards for the presentation of navigation-related information on shipborne navigational displays
- IMO MSC.252 (83): performance standards for an integrated navigation system (INS)
- IMO MSC.74 (69) Annex 2: performance standards for track control systems



- IMO MSC.191 (79), MSC.232 (82): performance standards for electronic chart display and information systems
- IMO MSC/Circular 266: maintenance of electronic chart display and information system (ECDIS) software
- IMO MSC/Circular 265: guidelines on the application of SOLAS regulation V/15 to INS, IBS and bridge design.

### 1.3 Definitions

**1.3.1** Configuration of complete system: all operational functions of the integrated bridge system as installed.

**1.3.2** Configuration available: operation(s) allocated to and available at each workstation.

**1.3.3** Configuration in use: operation(s) and task(s) currently in use at each workstation.

**1.3.4** Connectivity: a complete data link and the presence of valid data.

**1.3.5** Essential functions: functions related to determination, execution and maintenance of safe course, speed and position of the ship in relation to the waters, traffic and weather conditions.

Such functions include but are not limited to:

- route planning
- navigation
- collision avoidance
- manoeuvring
- docking
- monitoring of internal safety systems
- external and internal communication related to safety in bridge operation and distress situations.

**1.3.6** Essential information: that information which is necessary for the monitoring of essential functions.

**Table 1 : List of mandatory equipment**

Equipment	Additional class notation	
	SYS-IBS	SYS-IBS-1
Integrated Navigation System (INS)	optional	INS
Multifunction displays - according to MSC .191(79)	yes	yes
Radar (1)	CAT 1(H)/2(H)/3(H)	CAT 1(H)C
Gyrocompass	two	two
Magnetic compass	yes	yes
Spare Magnetic compass or second gyrocompass fed by main and emergency power supply and in addition by a transitional power supply (e.g. battery)	yes	yes
Transmitting Heading Device (THD)	yes	yes
Track Control System (TCS), class C	yes	yes
ECDIS with backup	yes	yes
Position receiver (GNSS...)	two	two
Conning display (it must include alarms from navigation and engine automation)	yes	yes
Bridge navigation watch alarm system (BNWAS)	yes	yes
Alarm transfer system	yes, at least to master's cabin	yes, at least to master's cabin
Central alarm panel	yes	yes
Echo sounder	yes	yes
Speed and Distance Measuring Equipment (SDME) (2)	yes	yes
Sound reception (if totally enclosed bridge)	yes	yes
VHF at conning position	one	one
NAVTEX	yes	yes
Weather chart facsimile	yes	yes
Wind speed and direction	yes	yes
AIS	yes	yes
VDR	yes	yes
<p>(1) According to Ch 4, Sec 1, [4.2.1]  H: when approved for high speed applications  C: approved with a chart option</p> <p>(2) Speed of the ship through the water and over the ground</p>		

**1.3.7** Functionality: ability to perform an intended function. The performance of a function normally involves a system of displays and instrumentation.

**1.3.8** IMO requirements: IMO Conventions, Regulations, Resolutions, Codes, Recommendations, Guidelines, Circulars and related ISO and IEC standards.

**1.3.9** Integrated bridge system (SYS-IBS): any combination of systems which are interconnected in order to allow centralised access to sensor information from workstations to perform two or more of the following operations:

- passage execution
- communications
- machinery monitoring
- loading, discharging and cargo monitoring, including HVAC for passenger ships.

**1.3.10** Integrity: ability of a system to provide users with accurate, timely, complete and unambiguous information and warnings within a specified time when the system is not in use.

**1.3.11** Latency: time interval between an event and the resulting information, including time for processing, transmission and reception.

**1.3.12** Multi-function display: a single visual display unit which can present, either simultaneously or through a series of selectable pages, information from more than one operation of an integrated bridge system.

**1.3.13** Novel systems or equipment: systems or equipment which embody new features not fully covered by provisions of SOLAS V but which provide an at least equivalent standard of safety (draft revision IMO SOLAS V, NAV 43/J/1, Regulation 19.6).

**1.3.14** Part: individual subsystem, equipment or module.

**1.3.15** Performance check: a representative selection of short qualitative tests, to confirm correct operation or essential functions of the integrated bridge system.

**1.3.16** Sensor: a device which provides information to or is controlled or monitored by the integrated bridge system.

**1.3.17** Passage execution: the function of passage execution in an Integrated Bridge System (IBS), as defined by IEC 61209, may be performed by an INS.

**1.3.18** Tack Control System (TCS) of category C: full track control on straight legs and turns.

## 1.4 Abbreviations

**1.4.1** Abbreviations used in this standard and annexes:

- AIS : Automatic identification system
- DSC : Digital selective calling
- EGC : Enhanced group call
- EPIRB : Emergency position indicating radio beacon
- GMT : Greenwich Mean Time
- HF : High frequency

INMARSAT: International Mobile Satellite Organisation

ISO : International Standards Organisation

ITU-R : International Telecommunication Union - radio sector

ITU-T : International Telecommunication Union - telecommunication sector

MARPOL: IMO Convention for the prevention of pollution by ships

MEPC : IMO Marine Environmental Protection Committee

MF : Medium Frequency

MSC : IMO Maritime Safety Committee

NAV : IMO Subcommittee on Safety of Navigation

NAVTEX: System for broadcast and reception of maritime safety information

OOW : Officer of the watch

r.p.m. : Revolutions per minute

UTC : Universal coordinated time

VDU : Visual display unit

VHF : Visual high frequency.

## 2 Documentation

### 2.1 Documents to be submitted

**2.1.1** In addition to the documents mentioned in Pt C, Ch 3, Sec 1, Tab 1 and the requirement in Pt C, Ch 3, Sec 1, [2.1.1], documents according to Tab 2 are to be submitted.

## 3 General requirements

### 3.1 General

**3.1.1** The integrated bridge system is to comply with all applicable IMO requirements as contained in the reference regulations listed in [1.2] or other relevant IEC Standards. Parts executing multiple operations are to meet the requirements specified for each individual function they can control, monitor or perform. By complying with these requirements, all essential functions remain available in the event of a single failure. Therefore, means for operation independent of the integrated bridge system are not required.

**3.1.2** Each part of an integrated bridge system are to meet the relevant requirements of IMO Resolution A.694(17) as detailed in IEC 60495. As a consequence, the integrated bridge system is in compliance with these requirements without further environmental testing to IEC 60945.

Software is to be developed in accordance with Pt C, Ch 3, Sec 3

**3.1.3** Where implemented, passage execution is not to be interfered with by other operations.

**3.1.4** A failure of one part is not to affect the functionality of other parts except for those functions directly dependent upon the information from the defective part.

**Table 2 : Documentation to be submitted**

No.	I/A (1)	Documentation
1	A	General arrangement of the bridge showing the position of the control console and panels
2	A	Plans showing the field of vision from each workstation
3	A	List and specification of navigational equipment fitted on the bridge and references (Manufacturer, type...)
4	A	List of alarms and instrumentation fitted on the bridge
5	I	List and specification of automation equipment fitted on the bridge and references (Manufacturer, type...)
6	A	Functional block diagram indicating the relationship between the items of navigational equipment and between them and other equipment
7	A	Functional block diagram of automation equipment remote controlled from the bridge
8	A	Diagram of electrical supply to the navigational and automation equipment fitted on the bridge
9	A	Diagram of the system linking the bridge alarms with the other operational locations (2)
10	A	Diagram of the communication systems (2)
11	A	Diagram of the BNWAS (2)
12	A	Test program including test method
<p>(1) A: to be submitted for approval I: to be submitted for information.</p> <p>(2) Documents to be submitted only when a <b>SYS-IBS-1</b> notation is requested.</p>		

## 3.2 Integration

**3.2.1** The functionality of the integrated bridge system is to ensure that operations are at least as effective as with stand-alone equipment.

**3.2.2** Continuously displayed information is to be reduced to the minimum necessary for safe operation of the ship. Supplementary information is to be readily accessible.

**3.2.3** Integrated display and control functions are to adopt a consistent man-machine interface philosophy and implementation. Particular consideration is to be given to:

- symbols
- colours
- controls
- information priorities
- layout.

**3.2.4** Where multi-function displays and controls are used to perform functions necessary for safe operation of the ship, they are to be duplicated and interchangeable.

**3.2.5** It is to be possible to display the complete system configuration, the available configuration and the configuration in use.

**3.2.6** Any unintentional change of a configuration is to be brought to the immediate attention of the user. An unintentional change of the configuration in use is, in addition, to activate an audible and visual alarm.

**3.2.7** Each part to be integrated is to provide details of its operational status and the latency and validity of essential

information. Means is to be provided within the integrated bridge system to make use of this information.

**3.2.8** An alternative means of operation is to be provided for essential functions.

**3.2.9** For integrated machinery control, it is to be possible for all machinery essential for the safe operation of the ship to be controlled from a local position.

**3.2.10** An alternative source of essential information is to be provided. The integrated bridge system is to identify loss of either source.

**3.2.11** The source of information (sensor, result of calculation or manual input) is to be displayed continuously or on request.

## 3.3 Data exchange

**3.3.1** Interfacing within the integrated bridge system and to an integrated bridge system is to comply with IEC 61162, as applicable.

**3.3.2** Data exchange is to be consistent with safe operation of the ship. The Manufacturer is to specify in the System Specification Document (SSD) the maximum permissible latency for each function considering the use of fast control loop, normal control loop, essential information and other information.

**3.3.3** Corrupted data are not to be accepted by the integrated bridge system. Corrupted or missing data are not affect functions which are not dependent on this data.

**3.3.4** The integrity of data flowing on the network is to be ensured.

**3.3.5** The network is to be such that in the event of a single fault between nodes there an indication, the sensors and displays on the network continue to operate and data transmission between them is maintained.

**3.3.6** A failure in the connectivity is not to affect independent functionality.

### 3.4 Failure analysis

**3.4.1** A failure analysis is to be performed and documented.

**3.4.2** Parts, functions and connectivity are to be identified.

**3.4.3** Possible failures of parts and connectivity associated with essential functions and information are to be identified.

**3.4.4** Consequences of failures with respect to operation, function or status of the integrated bridge system are to be identified.

**3.4.5** Each failure is to be classified with respect to its impact on the integrated bridge system taking into account relevant characteristics, such as detectability, diagnosability, testability, replaceability and compensating and operating provisions.

**3.4.6** The results of the failure analysis are to confirm the possibility of continued safe operation of the ship.

### 3.5 Quality assurance

**3.5.1** The integrated bridge system is to be designed, developed, produced, installed, and serviced by companies certified to ISO 9001 or ISO 9002, as applicable.

## 4 Operational requirements

### 4.1 Human factors

**4.1.1** The integrated bridge system is to be capable of being operated by personnel holding appropriate certificates.

**4.1.2** The man-machine interface (MMI) is to be designed to be easily understood and in a consistent style for all integrated functions.

**4.1.3** Operational information is to be presented in a readily understandable format without the need to transpose, compute or translate.

**4.1.4** Indications, which may be accompanied by a short low intensity acoustic signal, are to occur when:

- an attempt is made to execute an invalid function
- an attempt is made to use invalid information.

**4.1.5** If an input error is detected by the system it is to require the operator to correct the error immediately. Messages actuated by an input error are to guide the correct responses, e.g.: not simply "Invalid entry", but "Invalid entry, re-enter set point between 0 and 10".

**4.1.6** Layered menus are to be presented in a way which minimises the added workload to find and return from the desired functions.

**4.1.7** An overview is to be easily available to assist the operator in the use of a multiple page system. Each page is to have a unique identifier.

**4.1.8** Where multi-function displays are used, they are to be in colour. Continuously displayed information and functional areas, e.g. menus, are to be presented in a consistent manner.

**4.1.9** For actions which may cause unintended results, the integrated bridge system is to request confirmation from the operator.

Note 1: Examples of such actions are:

- attempting to change position of next waypoint while in track mode steering
- attempting to switch on bow thruster when insufficient electrical power is available.

**4.1.10** Functions requested by the operator are to be acknowledged or clearly indicated by the integrated bridge system on completion.

**4.1.11** Default values, where applicable, are to be indicated by the integrated bridge system when requesting operator input.

**4.1.12** For bridge operation by one person, special consideration is to be given to the technical requirements in Ch 4, Sec 1, [1].

### 4.2 Functionality

**4.2.1** It is always to be clear from where essential functions may be performed.

**4.2.2** The system management is to ensure that one user only has the control of an input or function at the same time; all other users are to be informed of this by the integrated bridge system.

### 4.3 Training

**4.3.1** Manufacturers of integrated bridge systems are to provide training possibilities for the ship's crew. This training may take place ashore or on board and is to be carried out using suitable material and methods to cover the following topics:

- General understanding and operation of the system:
  - knowledge and understanding of the system's configuration and application
  - reading and understanding of the operating manual
  - usage and understanding of brief description and instructions provided on the bridge
  - usage and understanding of electronic "HELP"-functions, if provided in the system
  - familiarisation with the system using safe trial modes

- Mastering of uncommon conditions in the system:
  - detecting and locating of failures
  - resetting the system to safe default values and modes
  - operating safely without certain sensor data or parts
  - possibilities for repair on board
  - identifying the potential for unintended results
- Methods and support for providing the above-mentioned training may be, for example:
  - printed material
  - training courses
  - video films
  - computer based learning programmes
  - simulation of different situations or data
  - recorded speech.

## 5 Technical requirements

### 5.1 Sensors

**5.1.1** In order to ensure an adequate system functionality, the sensors employed are to be able to comply with the following, as applicable:

- a) ensure communication compatibility in accordance with the relevant international marine interface Standard IEC 61162; and provide information about their operational status and about the latency and validity of essential information
- b) respond to a command with minimal latency and indicate receipt of invalid commands, when remote control is employed
- c) have the capability to silence and re-establish the audible portion of the local alarm
- d) have information documented about deterministic and stochastic errors and how they are handled, insofar as signals are pre-processed locally, e.g. plausibility check.

### 5.2 Alarm management

**5.2.1** The integrated bridge system alarm management as a minimum is to comply with the requirements of the Code on Alerts and Indicators, (IMO Resolution A.1021(26)) and the alarms required for each navigational equipment by IMO standards.

**5.2.2** Appropriate alarm management on priority levels (see [5.2.5]) and grouping of alarms based on operations and tasks is to be provided within the integrated bridge system.

Note 1: The purpose of grouping of alarms is to achieve the following:

- to reduce the variety in type and number of audible and visual alarms and indicators so as to provide quick and unambiguous information to the personnel responsible for the safe operation of the ship
- to readily identify any abnormal situation requiring action to maintain the safe operation of the ship
- to avoid distraction by alarms which require attention but do not require immediate action to restore or maintain the safe operation of the ship.

**5.2.3** The number of alarms is to be kept as low as possible by providing indications for information of lesser importance.

**5.2.4** Alarms are to be displayed so that the reason for the alarm and the resulting functional restrictions can be easily understood. Indications are to be self-explanatory.

**5.2.5** Alarms are to be prioritised as follows:

- a) emergency alarms: alarms which indicate that immediate danger to human life or to the ship and its machinery exists and that immediate action is to be taken
- b) distress, urgency and safety alarms: alarms which indicate that a mobile unit or a person is in distress, or the calling station has a very urgent message concerning the safety of a mobile unit or a person, or has an important warning to transmit
- c) primary alarms: alarms which indicate a condition that requires prompt attention to prevent an emergency condition as specified in statutory and classification rules and regulations
- d) secondary alarms: alarms which are not included above.

### 5.3 Human factors

**5.3.1** A multi-function display, if used, is to be a colour display.

**5.3.2** The size, colour and density of text and graphic information presented on a display are to be such that it may be easily read from the normal operator position under all operational lighting conditions.

**5.3.3** Symbols used in mimic diagrams are to be standardised throughout the system's displays.

**5.3.4** All information is to be presented on a background providing high contrast and emitting as little light as possible at night.

### 5.4 Power interruptions and shutdown

**5.4.1** If subjected to an orderly shutdown, the integrated bridge system is, upon turn-on, to come to an initial default state.

**5.4.2** After a power interruption full functionality of the integrated bridge system is to be available following recovery of all subsystems. The integrated bridge system is not to increase the recovery time of individual subsystem functions after power restoration.

**5.4.3** If subjected to a power interruption, upon restoration of power the integrated bridge system is to maintain the configuration in use and continue automated operation as far as practicable. Safety related automatic functions, e.g. automated steering control, are only to be restored upon confirmation by the operator.

## 5.5 Power supply

**5.5.1** General power supply requirements are summarised in Tab 3.

**5.5.2** Power supply requirements applying to parts of the integrated bridge system as a result of other IMO requirements remain applicable.

**5.5.3** The integrated bridge system is to be supplied:

- from the main and emergency sources of power with automated change-over through a local distribution board with provision to preclude inadvertent shutdown,
- from a transitional source of power for a duration of not less than 1 min, and
- where required in Tab 3, parts of the integrated bridge system are also to be supplied from a reserve source of power.

**Table 3 : Power supply requirements in addition to the main source of energy**

	Reserve source of energy (2)	Transitional source (1)	Emergency source (1)
Integrated bridge system		X (3)	X
VHF voice and DSC	X (4)		X (5)
MF voice and DSC	X (6)		X (7)
MF/HF voice, DSC and telex	X (6)		X (7)
INMARSAT ship earth station	X (6)		X (7)
EGC receiver	X (6)		X (7)
EPIRB	X (8)		X (8)
SAR transponders			X (9)
Aeronautical VHF SAR voice transceiver	X		X (10)
Lighting for radio installation (11)	X (12)		X
Equipment providing inputs to the radio installation	X (13)		X
Internal communication equipment and signals required in an emergency		X (14)	X
Magnetic compass and repeaters			X (9)
ECDIS or automatic graphical position display			X (9)
Automatic identification system (AIS)		X	X (9)
Electronic position fixing system	X (13)		X (9)
Radar			X (9)
Gyrocompass and repeaters	X (18)		X (9)
Echo sounder			X (9)
Speed and distance log			X (9)
Rudder angle indicator			X (9)
Propeller rpm, thrust direction and pitch as applicable			X (9)
Heading control system			X (9)
Rate of turn indicator			X (9)
Voyage data recorder (VDR)			X (9)
Track control system (TCS)			X (9)
Integrated navigation system			X (9)
Bridge navigation watch alarm system (BNWAS)			X (9)
Weather chart facsimile			X (9)
NAVTEX receiver	X		X (9)
Transmitting heading device (THD)			X (9)
Fire detection and alarm system		X (14)	X
Fire door holding and release		X (15)	X
Daylight signalling lamp, ship's whistle and manually operated call points		X (14)	X
Emergency lighting and navigation lights		X (14)	X
Fire pump			X
Automatic sprinkler pump			X (15)

	Reserve source of energy (2)	Transitional source (1)	Emergency source (1)
Emergency bilge pump and remote controlled bilge valves			X (15)
Steering gear			X
Power-operated watertight doors and associated control, indication and alarm circuits		X (15)	X (15)
Lift cars			X (15)
Machinery alarm system (16)			X
Alarm transfer system for one person operated bridge (17)			X
Multifunction displays - according to MSC.191(79)			X (9)
Conning display			X (9)
Call system (back-up Officer)			X
<p>(1) Emergency and transitional sources are defined in SOLAS II-1/42 and /43. Where the emergency source is an accumulator battery, a transitional source of emergency electrical power is not required, unless otherwise stated.</p> <p>(2) Reserve source for radio installations is defined in SOLAS IV/13.</p> <p>(3) A transitional source is required for essential functions of the integrated bridge system.</p> <p>(4) Reserve source is required by SOLAS IV/13.2 for the installation to SOLAS IV/7.1.1.</p> <p>(5) Emergency source is required by SOLAS II-1/42.2.2.2 and 43.2.3.2 responsible for installations to SOLAS IV/7.1.1, 7.1.2 and 7.1.5.</p> <p>(6) Reserve source is required by SOLAS IV/13.2 for the installation to SOLAS IV/9.1.1, 10.1, 10.2.1 and 11.1 as appropriate for the sea area(s) for which the ship is equipped.</p> <p>(7) Emergency source is required by SOLAS II/1/42.2.2.2.1, 42.2.2.2.2 and 42.2.2.2.3 and 43.2.3.2.1, 43.2.3.2.2 and 43.2.3.2.3 responsible for installations to SOLAS IV/9.1.1, 9.1.2, 10.1.1, 10.1.2, 10.1.3, 10.2.1, 10.2.2 and 11.1 if applicable.</p> <p>(8) If position input provided from external equipment.</p> <p>(9) Local distribution panel(s) are to be arranged for all items of electrically operated navigational equipment. Each item is to be individually connected to its distribution panel. The power supplies to the distribution panel(s) are to be arranged with automatic change-over facilities between the main and the emergency source (IACS UR N1).</p> <p>(10) If not equipped with primary batteries.</p> <p>(11) Required by SOLAS IV/6.2.4.</p> <p>(12) Reserve source may be used (SOLAS IV/13.5) as supply independent from main and emergency sources.</p> <p>(13) Reserve source may be used (SOLAS IV/13.8) for ship's navigational or other equipment which needs to supply uninterrupted input of information to the radio installation to ensure its proper performance as required by SOLAS IV.</p> <p>(14) For cargo ships a transitional source is not required if the emergency source is a generator which can be automatically started and supply the required load within 45 s (see also (1)).</p> <p>(15) Required for passenger ships only (see also (1)).</p> <p>(16) A standby power supply with automatic change-over from normal power supply is required by SOLAS II-1/51.2.1.</p> <p>(17) A standby power supply with automatic change-over from normal power supply is required by IACS UR N1.</p> <p>(18) If forming part of GDMDSS installation.</p>			

## 6 Testing

### 6.1 Introduction

**6.1.1** The following tests to be carried out by the Shipyard and the Manufacturers are intended to supplement and not replace testing of parts that is required to meet the relevant IMO performance standards. They are intended to ensure that when parts are integrated there is no degradation of their individual functionality and the overall system meets the requirements contained in Ch 1, Sec 1, [4] and Ch 1, Sec 1, [5].

**6.1.2** In all instances the performance standards for parts will form the minimum test requirement for an integrated system. Parts previously type approved will not require re-testing. Bridge-mounted parts for which no IMO performance standard exists are to be tested to the requirements of IEC 60945. Integration aspects of the integrated bridge

system are to require testing to ensure compliance with requirements contained in Ch 1, Sec 1, [4] and Ch 1, Sec 1, [5].

**6.1.3** The tests and confirmation set forth in [6.2] to [6.4] are to be reported in writing by the Shipyard and Manufacturers. This report is to be submitted to the Society for information.

### 6.2 General requirements

**6.2.1** The Manufacturer is to state the operations intended to be performed by the integrated bridge system.

**6.2.2** Since each integrated bridge system may integrate an individual set of operations and parts, it is not possible to define in advance which IMO requirements apply. Therefore, the following steps are to be taken with each individual integrated bridge system considered:

- a) Produce a matrix of the applicable IMO requirements:
- collect IMO requirements referring generally to **SYS-IBS** (e.g. SOLAS Chapter V and Code on Alerts and Indicators (IMO A.1021 (26))
  - collect IMO requirements applicable to the operations stated in [6.2.1] (e.g. if a radar/ARPA is integrated, collect IMO MSC.192 (79))
  - identify the individual parts of the integrated bridge system and their interfaces
  - identify parts executing multiple operations
  - identify functions necessary to perform the operations stated in [6.2.1]
  - identify power supply requirements for the individual parts of the integrated bridge system from Tab 3.
- b) Verify the validity of the appropriate type approval certificates Ch 1, Sec 1, [4.1.1].
- c) Verify that all functions identified in a) are performed Ch 1, Sec 1, [4.1.1].

**6.2.3** In addition, the following is to be carried out:

- Confirm compliance with IEC 60945 by one of the following:
  - a valid type approval certificate
  - a test certificate issued by an appropriate body
  - successful completion of appropriate tests Ch 1, Sec 1, [4.1.2].
- Confirm by examination of the (SSD)(s) that operational functions in addition to passage execution are implemented on a non-interference basis [3.1.3].
- Independently disable each part identified in [6.2.2] a) and determine by a test that only those functions dependent on the disabled part are affected [3.1.4].
- Confirm by examination that only minimum information necessary for the safe operation of the ship and as applicable to the configuration in use is continuously displayed and that supplementary information is readily accessible [3.2.2].
- Where IMO requirements governing the symbols, colours, controls, information priorities and layout of the integrated display and control functions exist, confirm compliance by examination. Where no such requirements exist, confirm by examination that the use of symbols, colours, controls, information priorities and layout is consistent [3.2.3].
- Where used, confirm by examination that there are at least two identical and interchangeable multi-function displays and controls [3.2.4].
- Confirm by examination that it is possible to display the configuration of the complete system, the configuration available and the configuration in use [3.2.5].
- Disable a part of the configuration in use and confirm that an audible and visual alarm is activated [3.2.6].
- Confirm by examination of relevant certificates and documentation that each part integrated in the integrated bridge system provides details of its operational status and latency and validity of essential information. Confirm by a performance check that changes in status

of the parts and of the latency and validity of information are used by the integrated bridge system in a safe and unambiguous manner [3.2.7].

- Confirm by examination of the SSD that there is an alternative means of performing each applicable essential function [3.2.8].
- Confirm by examination of the SSD that for integrated machinery control, it is possible for all machinery essential for the safe operation of the ship to be controlled from a local position.
- Confirm by examination that there is an alternative source of essential information. Confirm by a performance check that loss of essential information is recognised by the integrated bridge system.
- Confirm by examination that the source of information is displayed continuously or on request [3.2.11].
- Confirm by examination of relevant certificates and documentation that interfacing complies with IEC 61162, as applicable [3.3.1].
- Confirm by examination of the SSD that the stated latencies are appropriate to all intended operations. Confirm by examination of the Manufacturer's SSD that the stated latencies are achieved while the network is loaded to its maximum expected loading [3.3.2].
- Confirm by a performance check that corrupted data is not accepted by the integrated bridge system and that corrupted and missing data does not affect functions which are not dependent on this data Ch 1, Sec 1, [4.3.3].
- Confirm by examination of the Manufacturer's SSD that, as a minimum, data includes a check-sum in accordance with IEC 61162-1 and that, in addition, limit checking is applied to essential data [3.3.4].
- Create a representative number of single faults between network nodes and confirm that there is an indication of the fault, the displays and sensors continue to operate and data transmission is maintained Ch 1, Sec 1, [4.3.4].
- Identify the system connectivity by examination of the SSD. Independently interrupt each connection and determine by a performance check that only those functions dependent on the connection are affected and that all essential functions can still be performed [3.3.6].
- Confirm by examination of the SSD that a failure analysis has been performed and documented. The results of the failure analysis and the possibility of continued safe operation of the ship are to be verified by testing a representative selection of failures Ch 1, Sec 1, [4.4.1].
- Confirm by examination of the relevant certificate(s) that the Manufacturer complies with ISO 9000 Series Standards Ch 1, Sec 1, [4.5.1].

## 6.3 Operational requirements

**6.3.1** The following tests are carried out:

- Confirm by examination that the integrated bridge system includes displays, controls and instrumentation necessary to perform the functions identified in [6.2.2] a).



- Confirm by a performance check, conducted by suitably qualified personnel, that information presented is understandable without the need to transpose, compute or translate and that operation of integrated functions of the integrated bridge system identified in [6.2.2] a) is as effective as for equivalent stand-alone equipment [3.2.1], [4.1.1] and [4.1.2].
  - Confirm by examination of the Manufacturer's SSD that the specific requirements in MSC/Circular 566, paragraphs 10 to 32, are met, if applicable (Ch 1, Sec 1, [5.1.2]).
  - Confirm by a performance check that normal execution of functions and use of information are not accompanied by acoustic signals. If provided, ensure that acoustic signals accompanying attempts to execute an invalid function or use invalid information are short, of low intensity and clearly distinguishable from alarms (Ch 1, Sec 1, [5.1.3]).
  - Create an input error and ensure that immediate correction is required and that relevant guidance is given [4.1.5].
  - Confirm by a performance check, conducted by suitably qualified personnel, that layered menus, if provided, are presented such as to minimise workload [4.1.6].
  - If provided, ensure that multiple pages are uniquely identified and that an overview is available [4.1.7].
  - Ensure that continuously displayed information and functional areas, e.g. menus, are presented in a consistent manner in multi-function displays [4.1.2], [4.1.8].
  - Initiate a situation causing a potentially unintended result and ensure that the result is identified and that confirmation of the action is requested from the operator [4.1.9].
  - Confirm by a performance check that completion of functions is acknowledged [4.1.10].
  - Confirm that there is an indication of configuration available at each workstation [4.2.1].
  - Confirm that essential functions cannot be performed simultaneously at more than one workstation and that there is an indication of the configuration in use at each workstation [4.2.2].
- respond to a command with minimal latency and indicate receipt of invalid commands, when remote control is employed
  - have the capability to silence and re-establish the audible portion of the local alarm
  - have information documented about deterministic and stochastic errors and how they are handled.
- Initiate a situation identified in the SSD as requiring immediate reaction by an operator and confirm that the resultant alarm complies with IMO A.1021 (26) (see [5.2.1]).
  - Create conditions necessary to generate all types of alarms and indications listed in the matrix prepared in [6.2.2] a).
  - Confirm that appropriate alarm management on priority levels and functional groups is provided and that the number of the alarm types and their release is kept as low as possible by providing indications for information of lesser importance [5.2.2], [5.2.3].
  - Confirm that alarms are displayed so that the reason for the alarm and the resulting functional restrictions can be easily understood and that indications are self-explanatory [5.2.4].
  - Confirm that alarms are prioritised as emergency alarms, distress, urgency and safety alarms, primary alarms and secondary alarms [5.2.5].
  - Confirm by examination, performed by suitably qualified personnel, that:
    - a multi-function display is a colour display [5.3.1]
    - the size, colour and density of text and graphic information displayed on a VDU are such that it can be easily read from the normal operator position under all operational lighting conditions [5.3.2]
    - symbols used in mimic diagrams are standardised throughout the system's displays [5.3.3]
    - all information is presented on a background providing high contrast and emitting as little light as possible at night [5.3.4].
  - Perform an orderly shutdown of the integrated bridge system and confirm that when power is turned on again, the default state specified in the SSD is reached [5.4.1].
  - Record the configuration in use and the recovery times of all subsystems. Disconnect all external sources of power and wait for expiration of the integrated bridge system transitional source of power. Restore power and wait for recovery of all subsystems. The recovery times of all subsystems are to be as recorded [5.4.2].
  - The IBS is to come to the configuration in use and continue automated operation as far as practicable. Verify that safety related automatic functions are continued only after confirmation [5.4.3].
  - Confirm by examination of the SSD that provision is made to comply with the power supply requirements listed in Tab 3 and in the matrix prepared in [6.2.2] a).

**6.3.2** The Manufacturer is to produce a written statement that training possibilities are provided and confirm by examination of the training material that it covers general understanding and operation and mastering of uncommon conditions (Ch 1, Sec 1, [5.3.1]).

## 6.4 Technical requirements

**6.4.1** The following tests are carried out:

- Confirm, as applicable, by examination of the SSD that sensors employed according to [5.1.1]:
  - communicate in accordance with IEC 61162
  - provide details of operational status, latency and validity of essential information

## SECTION 3

## COMMUNICATION SYSTEM (SYS-COM)

### 1 General

#### 1.1 Application

**1.1.1** The additional class notation **SYS-COM** may be assigned in accordance with Pt A, Ch 1, Sec 2, [6.5.4] to ships fitted with communication means between ship and shore in order to exchange data, and complying with the requirements of this Section.

The additional class notation **SYS-COM** is not applicable to ships fitted with remote control capabilities (autonomous level 2 or higher according to NI641 Autonomous Shipping).

Ships assigned with the additional class notation **SYS-COM** are to comply with:

- the requirements of [3] when the ship is granted with the additional class notation **CYBER SECURE**
- the requirements of [4], [5] and [6] otherwise.

Note 1: In general, the additional class notation **SYS-COM** may not be granted for ships assigned with the notation **CYBER SECURE**.

**1.1.2** The purpose of this Section is to enhance, by means of a risk based approach, the safety and security of technical solutions of communications onboard ship used for:

- data transfer from ship to shore (e.g. engine monitoring systems)
- remote monitoring and troubleshooting from shore
- onboard access to communication infrastructure located ashore
- data transfer from shore to ship, e.g. chart services or software updates.

The requirements of this Section apply to the network and related communication systems used for one or more of the functions listed above.

Typical SYS-COM architecture and its boundaries are illustrated in Fig 1.

**1.1.3** Shipborne communication equipment listed in IMO SOLAS Chapter IV are not to be used for [1.1.2] within the scope of this notation.

Communication systems and navigation equipment listed in IMO SOLAS Chapter V may be considered on a case by case basis.

**1.1.4** Wireless networks are not within the scope of this Section but can be connected to SYS-COM network through wireless gateway.

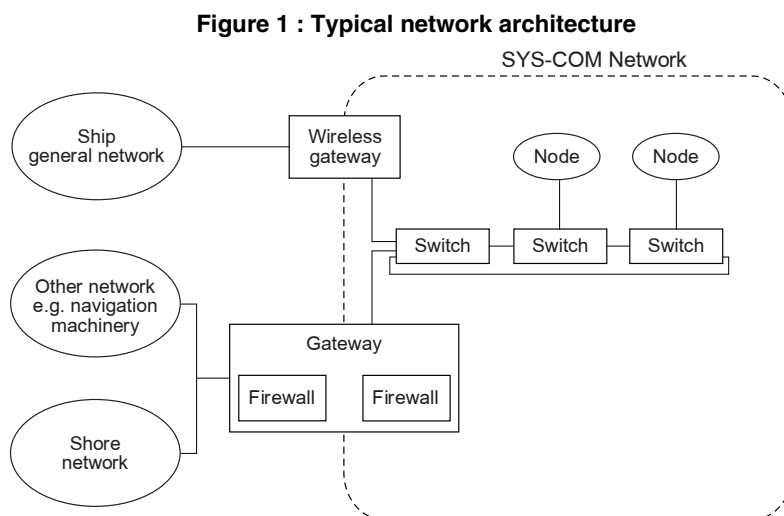
**1.1.5** The provisions of this Section apply without prejudice to Regulation EU 2016/679 "General Data Protection Regulation".

**1.1.6** Data transfer from shore to ship, for remote control of systems onboard ship is not permitted through SYS-COM network. Remote monitoring and maintenance is allowed and is to be secured according to the requirements of this Section.

#### 1.2 References

**1.2.1** The following standards are referred to in this Section:

- International Electrotechnical Commission (IEC):
  - IEC 61162 series – Maritime navigation and radio-communication equipment and systems - Digital interfaces
  - IEC 63154 ED1 - Maritime navigation and radio-communication equipment and systems – Cybersecurity – General requirements, methods of testing and required test results



- International Organization for Standardization (ISO):
  - ISO 9001 – Quality Management Systems - Requirements
  - ISO 27001:2013 – Information technology - Security techniques - Information security management systems - Requirements.
  - ISO/IEC 27005:2011 – Information technology - Security technique - Information security risk management.

**1.2.2** The following standards are listed for reference with regard to communication systems:

- IEC 60945 – Maritime navigation and radio communication equipment and systems - General requirements - Methods of testing and required test results
- IEC 61508 series – Functional safety of electrical / electronic / programmable electronic safety-related systems
- IEC 62443-3-3 – Industrial communication networks - Network and system security - Part 3-3: System security requirements and security levels

**1.2.3** The following industry guidelines may be referred to for guidance on cyber security on-board ships:

- ANSSI (Agence Nationale de la Sécurité des Systèmes d'Information) – Best practice for cyber security on-board Ships
- BIMCO (Baltic and International Maritime Council) – Guidelines on cyber security onboard ships.
- Bureau Veritas – BV SW100 Software development and assessment guidelines
- NIST (National Institute of Standards and Technology) – Cyber security framework
- Bureau Veritas - BV SW200 Cybersecurity guidelines for software development and assessment.

## 1.3 Definition

### 1.3.1 Communication system

Standalone or integrated computer-based information or operation technology, network, network nodes and network infrastructure.

### 1.3.2 Controlled network

A controlled network is any network that has been designed to operate such that it does not pose any security risks to any of its connected network nodes, as defined in IEC 61162-460. For the purpose of this Section, SYS-COM network is considered as the controlled network.

### 1.3.3 Ethernet

A carrier sense, multiple access collision detect (CSMA/CD) local area network protocol standard as defined in IEC 61162-450.

### 1.3.4 Functionality

Ability to perform an intended function. The performance of a function normally involves a system of displays and instrumentation.

### 1.3.5 Information technology

Automated system used for storing, retrieving, processing and transmitting data.

### 1.3.6 Network

One physical Ethernet network fitted onboard with one Internet address space, consisting only of the network node, switch, gateway, wireless gateway, cables and supporting equipment such as power supply units.

### 1.3.7 Network infrastructure

Part of a network that provides a transmission path between network nodes.

### 1.3.8 Network node

Physical device with embedded software that connect to the network and which have an Internet address e.g. switch, gateway, wireless gateway.

### 1.3.9 Operational technology

Automated systems, including hardware and software, that perform direct monitoring and/or control of physical devices, processes or events.

### 1.3.10 Other networks

The term “other networks” means networks not covered by the scope as defined in [1.1.2].

### 1.3.11 Quality of service (QoS)

A set of qualities related to the collective behaviour of one or more objects; as defined in ISO/IEC 13236:1998.

### 1.3.12 Remote Access

Ability to log onto a network from a distant location, such as personnel access to network resources through VPN (Virtual Private Network), or direct connection to control systems equipment by connection utilities by SSH (Secure Shell).

### 1.3.13 Safety

Protection of networks from un-intentional threats such as system mal-functioning, misconfiguration and misoperation; as defined in IEC 61162-460.

### 1.3.14 Security

Protection of networks from intentional threats such as virus, worm, denial-of-service attacks, illicit access, etc.; as defined in IEC 61162-460.

### 1.3.15 Threat

Potential cause of an incident in computer security that may result in harm to communication system; as defined in IEC 61162-460.

### 1.3.16 Traffic

Combination of all streams from a device; as defined in IEC 61162-460.

## 2 Documentation

### 2.1 Documents to be submitted

**2.1.1** In addition to the documents listed in Pt C, Ch 3, Sec 1, Tab 1, and the requirements in Pt C, Ch 3, Sec 1, [2.1.1], documents according to Tab 1 are to be submitted.

**Table 1 : Documentation to be submitted**

No.	I/A (1)	Documents
1	I	User manual, installation manual and maintenance manual of network and communication system
2	I	Functional description, Security functions description and Update policies report
3	I	Business continuity management report (include operational action plan on how to deal with a cyber-event to ensure the integrity of the ship)
4	A	Diagram of computer and network architecture, hardware and software list and characteristics
5	I	Specifications of "other networks" and communication system
6	I	List of data and description to be transmitted on the controlled network and their priority level, i.e. data classification list
7	I	List of data and description to be exchanged with the other external network and their priority levels
8	I	Communication software description of "other networks" (e.g. remote access) including software in receiving station ashore (e.g. protocol characteristics)
9	A	Appropriate method and test program on controlled network which demonstrates robustness and failure handling of the controlled network against malicious attack or fault. E.g. pen testing, screen testing, stress testing, fuzz testing, etc.
10	A	Software, firmware and application documents (2)
11	I	Safety risk analysis report
12	I	FMEA or FMECA report (3)
13	A	Security risk analysis report
14	I	Procedures for communication systems in accordance with Flag Administration requirements
<p>(1) A: to be submitted for approval; I: to be submitted for information.  (2) In accordance with Pt C, Ch 3, Sec 3.  (3) FMEA: Failure Mode and Effects Analysis; FMECA: Failure Mode, Effects and Criticality Analysis</p>		

### 3 Ships assigned with additional class notation **CYBER SECURE**

#### 3.1 General

**3.1.1** For ships assigned with the additional class notation **CYBER SECURE**, the communication system is to comply with the applicable requirements of NR659 "Rules on cyber security for the classification of marine units":

- Communication systems are to be designed in accordance with NR 659, Ch 3
- Communication systems which are remotely controlled are to be designed in accordance with NR 659, Ch2, Sec 3 [1] and NR 659, Ch 2, Sec 4, [2.2.9].

### 4 Design and operation of the communication system

#### 4.1 Communication

**4.1.1** The controlled network is to be hardwired using copper controlled network cables or optical fibre cables which are to be in compliance with Pt C, Ch 2, Sec 9.

**4.1.2** All connections with "other networks" are to use VPN through a gateway. All data exchanged with an uncontrolled network are to be encrypted to protect from security attacks, by using a strong encryption method.

**4.1.3** The controlled network nodes are to be able to detect corrupted data and manage it.

**4.1.4** All data are to be identified with a priority level in QoS to control transfer of traffic.

**4.1.5** The protocols used for data transfer are to be in accordance with IEC 61162 series.

**4.1.6** The communication systems are to comply with the requirements stated in Part C, Chapter 3.

**4.1.7** The communication system is to be designed and produced, in accordance with ISO 9001, a quality assurance scheme, to the satisfaction of the Society.

**4.1.8** In the controlled network, in order to maintain a high level of communication process availability in case of failure, fall-back arrangement is to be provided in order to enable transmission of critical data, defined by the Owner.

**4.1.9** The controlled network is to be segregated from administrative and internet access network by physical and virtual means.

#### 4.2 Quality assurance

**4.2.1** The controlled network equipment / systems listed in IEC 61162-450 and 460 are to be type approved. The type approval and tests procedure are to be carried out in accordance with Pt C, Ch 3, Sec 6 and IEC 61162 series.

**4.3.2** The controlled network is to be designed, developed, produced, installed, and serviced by companies certified in accordance with ISO 9001.

**4.3.3** The controlled network software, firmware and application are to be designed, developed, tested, installed and maintained in accordance with Pt C, Ch 3, Sec 3.

### 4.3 Safety

**4.3.1** The controlled network software is to be fault tolerant.

**4.3.2** Controlled network software registry and configuration management are to be in place.

**4.3.3** Controlled network software update is not to be performed while targeted system is on the operation mode.

**4.3.4** Notwithstanding [1.1.3], software and charts update of shipborne radio communication and navigation equipment listed in IMO SOLAS Chapter IV and Chapter V are not to be performed while navigating at sea.

In the scope of this notation, navigation and radiocommunication equipment are to be tested in accordance with IEC 63154 ED1.

**4.3.5** Failure of controlled network is not to endanger the reception and transmission of distress messages and other communications covered by the Rules and/or Statutory regulations (e.g. digital cordless telephone (DCT), public address).

**4.3.6** Failure of controlled network is not to lead to disruption of essential services on board.

**4.3.7** A safety risk analysis of controlled network and its immediate environment is to be performed and be used as the input of security risk analysis. The methodology given in NR 659, Ch 1, Sec 2 is to be applied for the safety risk analysis.

**4.3.8** A FMEA/ FMECA on the controlled network equipment availability and redundancy capability is to be performed and be used as the input of security risk analysis.

**4.3.9** Means and procedures are to be provided to immediately disconnect the controlled network communication system in case of attack or failure. The controlled network is to be regularly tested onboard by authorized people, the result is to be registered.

**4.3.10** In case of communication system failure, transition between main and back-up solution is to be automated and an alarm to be triggered.

**4.3.11** An alarm is to be triggered in case of a failure in automatic commutation. This alarm is to indicate which equipment is affected.

### 4.4 Security

**4.4.1** Software patch management of controlled network are to be put in place.

**4.4.2** The security risk analysis methodology is to comply with the applicable requirements of NR659, Ch 1, Sec 2

**4.4.3** Any exchange through the controlled network, regarding end-to-end industrial process safety, is to be protected with a malware protection solution. The malware protection solution is to be updated on a regular basis.

### 4.5 Operation

**4.5.1** All software and hardware components of information technology, operational technology and process control system that are remotely accessible through the communication system are to be protected by passwords and access control lists.

**4.5.2** Multi factor authentication (minimum two) for remote support is to be placed and demonstrated.

Remote session is to be activated by authorized personnel onboard only. The list of authorized personnel is to be integrated in the remote software and available onboard as onshore.

**4.5.3** For the remote support, access time is to be defined for a short period of time, is to be defined in the user manual, update policy or maintenance report and demonstrated.

**3.5.4** The communication endpoint onboard ship is to be authenticated by digital certificates, through a method compliant with the results of the security risk analysis.

**3.5.5** Factory default account and the passwords are not to be hard-coded and not left to their default value. If possible, unused default accounts and services are to be deleted. It has to be clearly defined in the operational manual, e.g. routers and switches.

**4.5.4** For communication system, the Owner is to implement procedures in accordance to Flag State legislation and submit it to the Society for information, e.g. navigation and radio communication.

## 5 Onboard testing

### 5.1

**5.1.1** The association and compatibility of approved product is to be demonstrated as it is described in the application limitation of their certificates.

**5.1.2** Correct installation of communication system such as hardware (cabling, location of aerials, and layout of consoles) and software (compatibility of assembled software, human / machine interface) are to be checked onboard.

**5.1.3** Correct functionality of communication system is to be verified onboard. Upon compliance of onboard tests, test reports are to be available to a Surveyor.

**5.1.4** Safety and Security requirements in [4.3] and [4.4] are to be correctly implemented and effective operation onboard ship is to be witnessed by a Surveyor.

## 6 Security recommendations

### 6.1

**6.1.1** In order to minimize the security risks and mitigate the threats for both onboard (technology, process and people) and also shore support center, the following good practices are recommended:

- a) If personnel onboard are allowed to bring their own devices (BYOD) on board to access the ships' system or network, policies and procedures should address their control, use, and how to protect vulnerable data, such as through network segregation.
- b) Physical security (physical access to critical systems) should be part of security policy onshore as well as on board and procedure be available onboard (see IMO ISPS code).
- c) The communication endpoint onshore should be secured to prevent malicious attacks on communication endpoints onboard ship.

- d) Critical software firmware and application of the controlled network and other network (including operational systems) can be developed and tested according to a recognised methodology.

Note 1: See BV SW-100 and BV SW-200 defined in [1.2.3].

- e) Testing of the controlled network and other network may be performed on regular basis in order to uncover new vulnerabilities.

Note 2: Example of testing methods are given in Tab 1, item 9.

- f) An emergency security plan is to be prepared and available in the bridge and machinery room.
- g) An internal training and quality procedure to be in place to insure that operators of the systems and crew are aware of their cyber security duties.
- h) The establishment of an information security management system (ISMS) according to the requirements of ISO/IEC 27001 is recommended.

Part F  
**Additional Class Notations**

Chapter 5

**MONITORING EQUIPMENT (MON)**

---

**SECTION 1 HULL STRESS AND MOTION MONITORING (MON-HULL)**

**SECTION 2 SHAFT MONITORING (MON-SHAFT)**

# SECTION 1 HULL STRESS AND MOTION MONITORING (MON-HULL)

## 1 General

### 1.1 Application

**1.1.1** The additional class notation **MON-HULL** is assigned in accordance with Pt A, Ch 1, Sec 2, [6.6.2] to ships equipped with a Hull Stress Monitoring System (hereafter referred to as Hull Monitoring System for easy reference), complying with the requirements of this Section.

The class notation **MON-HULL** is not applicable to High Speed Craft.

**1.1.2** A Hull Monitoring System is a system which:

- provides real-time data to the Master and officers of the ship on hull girder longitudinal stresses and vertical accelerations the ship experiences while navigating and during loading and unloading operations in harbour
- allows the real-time data to be condensed into a set of essential statistical results. The set is to be periodically updated, displayed and stored on a removable medium.

Extra information may be added in view of later exploitation by the Owner, for instance as an element in the exploitation of the ship or as an addition to its log-book.

Note 1: The information provided by the Hull Monitoring System is to be considered as an aid to the Master. It does not replace his own judgement or responsibility.

**1.1.3** The Hull Monitoring System is to be able to ensure the following main functions:

- acquisition of data: hull girder longitudinal strains and vertical accelerations at bow
- data processing: conversion in physical units, scaling, consistency checking, statistical processing and storage of results
- display management, handling of alarms and warnings
- detection of faults and malfunctions.

Note 1: The additional resources needed for the later onshore exploitation of the recorded results are not considered as part of the Hull Monitoring System.

### 1.2 Documentation

**1.2.1** The documents according to Tab 1 are to be submitted to the Society.

## 2 Sensors design

### 2.1 General

**2.1.1** The Hull Monitoring System is to be based on sensors designed to carry out the following measurements:

- measurements of the longitudinal strains in the main deck: the sensors will be located at one or several transversal sections where the maximum hull girder stress can be expected during navigation, loading or unloading. At least one transversal section will be equipped with two sensors located symmetrically at Port and Starboard
- measurements of the vertical acceleration at the bow.

**Table 1 : Documentation to be submitted**

No.	I/A (1)	Documentation
1	A	Description and metrological characteristics of the sensors and associated conditioning units
2	A	Diagram and functional scheme of the system
3	A	Sensors calibration procedures and certificates including calibration values and tolerances
4	A	Location of sensors
5	A	Detection of faults and malfunctions of the system
6	I	Principles and algorithm used for the data processing
7	I	User's manuals (installation and maintenance manual, using manual)
8	I	List of data to be transmitted to VDR, if any
(1) A: to be submitted for approval I: to be submitted for information		



## 2.2 Measurements ranges and tolerances

**2.2.1** Stress measurements of hull girder are related to the still water and wave and dynamic bending moments acting on the ship. For steel ships, a deformation range from  $-2000$  micro-strain to  $+2000$  micro-strain should be assumed.

The measurement uncertainty (including strain transducers parameters, calibration, resolution of acquisition system, etc.) is to be less than  $\pm 20$  micro-strain or  $\pm 5\%$  of the reading, whichever is the greater.

The typical bandwidth should be 0 Hz to 1,0 Hz.

**2.2.2** Acceleration measurements at the bow are related to the vertical motion (heave and pitch) of the ship and the first mode of the vertical vibration of the hull girder. Depending of the size of the ship, an acceleration range from  $-20$  m/s<sup>2</sup> to  $+20$  m/s<sup>2</sup> should be assumed.

The measurement uncertainty is to be less than  $\pm 0.2$  m/s<sup>2</sup> or  $\pm 5\%$  of the reading, whichever is the greater.

The typical bandwidth should be 0,02Hz to 1,0Hz.

## 2.3 On-site calibration of sensors

**2.3.1** The sensors are to be selected and installed in such a way that a periodical on-site recalibration can be carried out without extra equipment.

When this operation is impossible, the Manufacturer is to declare the period and procedure of calibration.

## 2.4 Environmental and EMC requirements

**2.4.1** The sensors and the associated conditioning units are to comply with the applicable requirements concerning electromagnetic compatibility and protection against environmental conditions. The installation is to be compliant with Pt C, Ch 3, Sec 5.

**2.4.2** The electrical equipment installed in hazardous areas are to be compliant to requirements of Pt C, Ch 2, Sec 2, [6] and Pt C, Ch 2, Sec 3, [10].

# 3 System design

## 3.1 General

**3.1.1** The Hull Monitoring system is to include at least:

- sensors and conditioning units
- a computer with the sufficient resources to perform the required tasks in real time (e.g. warnings and alarms are to be given out immediately)
- a display unit readable at a distance of at least 1 m
- a data storage unit with a removable medium, allowing for the statistical data to be exploited later
- as option, a data storage unit to record time data series from sensors (see [3.5.1])
- an UPS with 30 minutes autonomy (see [3.8.1]).

**3.1.2** The system is to be designed to detect, as far as possible the faults and the malfunctions of the system (e.g.):

- failure of main source of power
- data out of range
- data remaining strictly constant (failure of a transducer)
- system stops or hangs (the implementation of a Watch-dog is recommended).

Note 1: The detection of faults and malfunctions will trigger a visual and audible alarm.

## 3.2 Data processing

**3.2.1** The system is to be designed in order to measure and process the stresses induced by still water, wave and dynamic hull girder loads as defined in Pt B, Ch 5, Sec 1 and the accelerations which result from the ship motions as defined in Pt B, Ch 5, Sec 3.

**3.2.2** Data processing is to be carried with the provision of the following requirements:

- analogue low-pass filters are to be used in accordance with the required bandwidth
- the sampling frequency is to be at least 20 times the low-pass filtering frequency
- the processing ranges of stress and acceleration are to be fixed in accordance with the calculated stress and acceleration limits for the ship, and will allow possible overshooting
- the signals are to be processed through a cyclic statistical procedure. The procedure (e.g. peak value, N/10 and N/3 averages, RMS value, mean value, etc.) will allow to record a set of statistical data for an off-line exploitation and to display real time values for an on-line exploitation
- the recording duration per cycle is to be adapted to produce results that are not to deviate by more than 10% from one wave encounter to the next in steady navigation conditions. The recording duration per cycle is not to be less than 10 minutes.

**3.2.3** The information (still water bending moments or stresses) from loading calculator is to be exported to the Hull Monitoring System during loading and unloading.

The measured still water hull girder stresses is to be checked against the predicted values from the loading calculator.

**3.2.4** The system is to switch from port to sea conditions, and vice versa.

**3.2.5** Provision is to be made for a connection to a Voyage Data Recorder. The Manufacturer of the Hull Monitoring System is to declare which information would be forwarded to the Voyage Data Recorder.

The physical connection of the Hull Monitoring System to the Voyage Data Recorder is to be compliant with IEC 61162.

### 3.3 Data displaying

**3.3.1** The hull girder stresses and the vertical accelerations are to be displayed in real time (e.g. maximum values and current values). This information is to be declared as "default condition" and displayed at power up or reset.

In sea conditions, statistical data may be displayed on the same page without possibility of mix-up with the real time data.

**3.3.2** When a visual alarm/warning is emitted in accordance with [3.4], the corresponding information is superimposed on the above "default condition" displayed.

**3.3.3** When the system detects a fault or a malfunction, the corresponding status is to be displayed.

### 3.4 Alarms

**3.4.1** The alarms and warnings levels are to be settled in accordance with the following:

- the alarm levels are to be fixed to 80% of the maximum values obtained from the requirements on the basis of which the hull structure is approved
- the warning levels are always to be less than the alarm levels defined above.

**3.4.2** The alarms and warning associated with each limit defined in [3.4.1] are to be clearly distinguishable from those relevant to faults and malfunctions.

**3.4.3** When the system detects a fault or a malfunction, the alarms and warnings are to be inhibited and a visual and audible fault/malfunction alarm is to be emitted.

### 3.5 Data storage

**3.5.1** The time data series are to be stored either by the recording device which is part of the Hull Monitoring System, or by an integrated bridge system, if available.

The storage media used shall have a sufficient capacity to store at least 1 year of time data.

**3.5.2** The data storage recording device suitable for accumulating statistical information for feedback purposes is to be able to store at least 30 days of statistical data depending of ship's operation.

Statistical data are to be recorded in text format easily readable on a PC.

**3.5.3** The data storage recording devices are to be:

- entirely automatic, apart from the replacement of the removable storage support
- such that they do not interrupt or delay the processing of the data.

**3.5.4** The recorded data (time and statistical) must be time dated.

### 3.6 Exploitation of stored data

**3.6.1** The exploitation of the recorded statistical data according to [3.5.2] is let to the responsibility of the owner.

### 3.7 Checking facility

**3.7.1** The Hull Monitoring System is to include an auto-checking facility so that the verification of the System can be carried out without the need of external devices.

### 3.8 Power supply

**3.8.1** The Hull Monitoring System is to be supplied by the main source of power of the ship through an uninterruptible 30 minutes autonomy power source.

## 4 Installation and testing

### 4.1 General

**4.1.1** The components of the hull monitoring system including data processing, storage, display units and UPS are to be type approved in accordance with Pt C, Ch 3, Sec 6 (see also [2.4.1]).

The design of the display unit installed on the bridge is to be compliant to requirements of IEC 60945.

### 4.2 Installation of sensors

**4.2.1** Attention is drawn to the possible existence of local strains induced by temperature gradients in the hull structure.

The strain sensors are to be located in areas free from these temperature gradients.

If a temperature compensation device is implemented, the Manufacturer is to demonstrate its effectiveness on site. When measurement systems are based on strain gauges, temperature compensated strain gauges are to be used.

**4.2.2** Strain transducers are to be installed on the hull taking into account the influence of local stresses which may corrupt the global hull strain values.

### 4.3 Testing of Hull Monitoring System

**4.3.1** The first on-site calibration of the measuring system of hull stresses is to be based on an approved loading case in still water.

The differences between the readings obtained from the Hull Monitoring System and the approved values are to be less than 10 N/mm<sup>2</sup> or 10% of the reading, whichever is the greater.

**4.3.2** This first on-site calibration of the Hull Monitoring System is to be surveyed by the society.

## SECTION 2

## SHAFT MONITORING (MON-SHAFT)

### 1 General

#### 1.1 Applicability of MON-SHAFT notation

**1.1.1** The additional class notation **MON-SHAFT** is assigned, in accordance with Pt A, Ch 1, Sec 2, [6.6.3], to ships fitted with oil or water lubricated systems for tailshaft bearings complying with the requirements of this Section.

**1.1.2** The assignment of this notation allows a reduced scope for complete tailshaft surveys; see Pt A, Ch 2, Sec 2, [5.5.3].

**1.1.3** The requirements of this section apply in addition to those listed in Pt C, Ch 1, Sec 7, [2.4]

### 2 Requirements for oil lubricated tailshaft bearings

#### 2.1 Arrangement

**2.1.1** Oil sealing glands design is to be approved by the Society. Seals replacement is to be possible without shaft withdrawal.

**2.1.2** Aft most bearing is to be fitted with a temperature monitoring system.

**2.1.3** Aft most bearing is to be arranged with facilities for measurement of bearing wear down.

#### 2.2 Lubricating oil analysis

##### 2.2.1 Item to be monitored

In order for the notation **MON-SHAFT** to be granted, the lubricating oil of the stern bearing is to be analysed as indicated in this Section.

##### 2.2.2 Timing

Stern bearing lubricating oil is to be analysed regularly; in any event, the interval between two subsequent analyses is not to exceed six months.

##### 2.2.3 Records

The lubricating oil analysis documentation is to be available on board showing in particular the trend of the parameters measured according to [2.2.4].

##### 2.2.4 Content of analysis

Each analysis is to include the following parameters:

- water content
- chloride content
- bearing material and metal particle content
- oil ageing (resistance to oxidation).

The oil samples are to be taken under service conditions and are to be representative of the oil within the sterntube.

##### 2.2.5 Additional data to be recorded

In addition to the results of the oil sample analysis, the following data are to be regularly recorded:

- oil consumption
- bearing temperatures.

### 3 Requirements for water lubricated tailshaft bearings

#### 3.1 General requirements

**3.1.1** Bearing material is to be approved by the Society.

**3.1.2** The tailshaft is to be made of a corrosion-resistant material or protected against corrosion by a continuous liner or cladding

**3.1.3** The bearings are to be arranged with facilities for measuring the bearing wear down while the ship is afloat. The relevant procedure including the maximum permissible wear down will have to be submitted.

**3.1.4** Arrangements are to be made for endoscopic examination of the tailshaft surface in particular in way of the bearings with the shaft in place. The relevant procedure will have to be submitted to the Society.

**3.1.5** Where required by Pt C, Ch 1, Sec 7, [3.3], the shaft alignment calculations are to be performed for both initial conditions (new bearings) and conditions of maximum permissible wear down according to the bearing manufacturer's recommendations and deemed satisfactory by the Society.

**3.1.6** Sealing glands design is to be approved by the Society. Replacement of seals is to be possible without withdrawal of tailshaft.

#### 3.2 Additional requirements for forced water lubrication systems

**3.2.1** Water lubrication piping diagram is to be submitted for review.

**3.2.2** The water pumping system is to include:

- Two pumps
- A filtering system designed in accordance with bearing and pump manufacturer requirements
- Two independent flow sensors allowing permanent flow monitoring and activating an alarm in case of low flow.

**3.2.3** The operating restrictions of the propulsion installation in case of low flow alarm are to be stated.

**3.2.4** Filters are to be cleaned or replaced in accordance with manufacturer recommendations. Records of cleaning and replacement of filters are to be available onboard.

**3.2.5** Unless otherwise justified, an interlock arrangement is to be provided to prevent the propulsion starting if sufficient water flow is not established.

**3.2.6 Specific requirements for closed forced systems**

- a) Low and high level alarms to be fitted on water tank. Operating restrictions of the propulsion installation in case of low/high level alarms are to be stated
- b) Chloride content as well as presence of bearing material and other particles within fresh water piping system shall be analysed regularly. The interval between two subsequent analyses is not to exceed six months. The water analysis records are to be available onboard.

Part F  
**Additional Class Notations**

Chapter 6

**COMFORT ON BOARD (COMF)**

---

- SECTION 1      GENERAL REQUIREMENTS**
- SECTION 2      ADDITIONAL REQUIREMENTS FOR SHIPS OF LESS THAN  
1600 GT**
- SECTION 3      ADDITIONAL REQUIREMENTS FOR SHIPS GREATER THAN OR  
EQUAL TO 1600 GT - CREW AREAS**
- SECTION 4      ADDITIONAL REQUIREMENTS FOR SHIPS GREATER THAN OR  
EQUAL TO 1600 GT - PASSENGER AREAS**
- SECTION 5      ADDITIONAL REQUIREMENTS FOR YACHTS**

## Symbols used in this Chapter

MCR : Maximum continuous rating of the propulsion  
NCR : Nominal continuous rating of the propulsion  
dB : Decibel, unit of sound pressure level compared to the reference pressure level ( $2 \cdot 10^{-5}$  Pa)  
dB(A) : (A) weighted global value of the sound pressure level

octave band: Band of sound covering a range of frequencies such that the highest is twice the lowest

R.M.S. : Root Mean Square

Third (1/3) octave band: Band of sound covering a range of frequencies such that the highest is the cube root of two times the lowest.

# SECTION 1

# GENERAL REQUIREMENTS

## 1 General

### 1.1 Application

**1.1.1** The additional class notations **COMF-NOISE** and **COMF-VIB** are assigned, in accordance with Pt A, Ch 1, Sec 2, [6.7] to the following ships:

- Ships of less than 1600 GT (such as fishing ships, tugs, small passenger ships excluding yachts and pleasure crafts)
- Ships greater than or equal to 1600 GT (such as tankers, container ships, large fishing vessels, cruise ships, ferries, ...)
- Yachts.

The notations **COMF-NOISE** and **COMF-VIB** are to be completed as follows:

- **COMF-NOISE x**: Comfort with regard to noise criteria applicable to specified ship category  
with  $x = 1, 2$  or  $3$ , "1" corresponding to the most comfortable level for both passenger and crew spaces
- **COMF-VIB x**: Comfort with regard to vibration criteria applicable to specified ship category  
with  $x = 1, 2$  or  $3$ , the overall frequency weighted R.M.S. velocity criteria, "1" corresponding to the most comfortable level for both passenger and crew spaces, or  
with  $x = 1PK, 2PK$  or  $3PK$ , for the single amplitude peak velocity criteria, "1PK" corresponding to the most comfortable level for both passenger and crew spaces.

The requirements corresponding to those additional class notations are given in Ch 6, Sec 2 to Ch 6, Sec 5 for each concerned ship type.

The assignment of **COMF-NOISE** and **COMF-VIB** to passenger ships is to be done separately for passenger and crew spaces:

- **COMF Pax** deals with passenger comfort:  
**COMF-NOISE-Pax x** and **COMF-VIB-Pax x** may be granted accordingly with different grades
- **COMF Crew** deals with crew comfort:  
**COMF-NOISE-Crew x** and **COMF-VIB-Crew x** may be granted accordingly with different grades.

Note 1: For ships intended with in-service assessment, the notations **COMF** may be completed by **-SIS** as defined in Pt A, Ch 1, Sec 2, [6.7.1].

**1.1.2** High speed crafts which do not have the same kind of behaviour in the concerned fields (vibrations and noise) are not covered by these Rules.

### 1.2 Basic principles

#### 1.2.1 Measurement specialist

Granting of the comfort grade is made on the basis of measurements performed during sea trials or in service by an acoustic and vibration specialist, referred as the Measurement Specialist within this Chapter.

The Measurement Specialist is an acoustic and vibration specialist from an approved service supplier in accordance with NR533, or a qualified Surveyor from the Society.

**1.2.2** The granting of the comfort grade of a ship cannot be made on the basis of the measurements performed on any other ship of the considered series.

**1.2.3** These Rules take into account various International Standards, and are deemed to preserve their general principles.

### 1.3 Regulations, Standards

#### 1.3.1 Noise

The present Chapter refers to the following standards applicable to noise:

- IMO Resolution MSC.338(91), "Adoption of amendments to the international convention for the safety of life at sea, 1974"
- IMO Resolution MSC.337(91), "Adoption of the code on noise levels on board ships"
- ISO 2923, "Acoustics - Measurements of noise on board vessels"
- ISO 80000-8, "Quantities and Units - Part 8: Acoustics"
- IEC Publication 61672, "Electroacoustics-Sound level meters"
- IEC Publication 61260, "Octave, half-octave and third octave band filters"
- IEC Publication 60942, "Electroacoustics - Sound calibrators"
- ISO 16283-1, "Acoustics - Field measurement of sound insulation in buildings and of building elements - Part 1: Airborne sound insulation"
- ISO 16283-2, "Acoustics - Field measurement of sound insulation in buildings and of building elements - Part 2: impact sound insulation"
- ISO 717, "Acoustics - Rating of sound insulation in buildings and of building elements", namely:
  - Part 1, "Airborne sound insulation in buildings and interior elements"
  - Part 2, "Impact sound insulation"
- IEC Publication 60268-16, "Sound system equipment - Part 16: Objective rating of speech intelligibility by speech transmission index"

- ISO 1996, “Acoustics - Description, measurements and assessment of environmental noise”, namely:
  - Part 1, “Basic quantities and assessment procedure”
  - Part 2, “Determination of environmental noise levels”
- ISO 3382-1, “Acoustics - Measurement of room acoustic parameters”, namely:
  - Part 1, “Performance spaces”
  - Part 2, “Reverberation time in ordinary rooms”.

**1.3.2 Vibration**

The present Chapter refers to the following standards applicable to vibration:

- ISO 2041, “Vibration and shock - Vocabulary”
- ISO 6954:1984, “Mechanical vibration and shock - Guidelines for the overall evaluation of vibration in merchant ships”
- ISO 20283-5, “Mechanical vibration - Measurement of vibration on ships - Part 5: Guidelines for measurement, evaluation and reporting of vibration with regard to habitability on passenger and merchant ships”
- ISO 2631, “Mechanical vibration and shock- Evaluation of human exposure to whole-body vibration”
- ISO 8041, “Human response to vibration - Measuring instrumentation”.

**1.4 Definitions**

**1.4.1** In addition to the definitions given by IMO for crew spaces and SOLAS for passenger spaces, the following definitions are used in the present Chapter for the concerned ships:

- Passenger public spaces
  - Type A public space  
closed rooms normally manned at sea or recreational spaces where noise is generally high (discotheques)
  - Type B public space  
closed rooms permanently manned at sea where noise may be moderately high (restaurants, bars, cinemas, casinos, lounges, fitness rooms, gymnasiums and other closed sport areas).
  - Type C public space  
closed rooms permanently manned at sea requiring relatively low background noise (lecture rooms, libraries, theatres)
  - Type D public space  
closed rooms intermittently used at sea or passages which do not require very low background noise (halls, atriums, shops, corridors, staircases).
- Passenger cabins
  - Cabins are dealt with separately. Distinction between passenger cabins categories is to be made on the basis of Owner’s specifications.

**1.5 Document to be submitted**

**1.5.1** Prior to any sea trials, documents are to be submitted in relation with ship categories listed in Tab 1.

**Table 1 : Documents to be submitted**

No.	A/I (1)	Document
1	I	General arrangements
2	A	Measurement program: <ul style="list-style-type: none"> <li>• Measurement procedures</li> <li>• loading conditions</li> <li>• propulsion operating conditions</li> <li>• other equipment to be run</li> <li>• weather conditions</li> </ul>
(1) A = to be submitted for approval I = to be submitted for information		

**2 Conditions of attribution**

**2.1 Measurements**

**2.1.1** Measurements aiming at giving the comfort class notation have to be performed under the conditions specified in [3].

**2.1.2 Instrumentation**

a) General

Measurement and calibration equipment are to meet the requirements of:

- ISO 2923, IEC 61672-1, IEC 61260 and IEC 60942 for noise, and
- ISO 20283-5 or ISO 6954:1984 and ISO 8041 for vibration.

Sound insulation measurement is to be carried out according to ISO 16283-1.

Impact noise measurement is to be carried out according to ISO 16283-2.

Noise and vibration calibrators are to be verified at least every year by a national standard laboratory or a competent laboratory accredited according to ISO 17025 (2005) as corrected by (Cor 1:2006).

b) Noise measurements

Measuring equipment is to be verified at least every two years by a national standard laboratory or a competent laboratory accredited according to ISO 17025 (2005) as corrected by (Cor 1:2006).

The instrumentation has to be calibrated in situ before the tests and verified after. The deviation shall not exceed 0,5 dB.

c) Vibration measurements

The instrumentation has to include at least a transducer (accelerometer or velocity transducer) with an appropriate amplifier, and a FFT analyser. Measuring equipment is to be verified at least every two years. The instrumentation has to be calibrated in situ before the tests and verified after. The deviation shall not exceed 5%.

Should the vibration measurements be performed on a soft floor, the use of a transducer mounted on an appropriate three-spike plate is recommended. A rigid plate with the person standing on the plate and the accelerometer rigidly fixed on may be used.



### 2.1.3 Data processing and analysis

#### a) For noise level

The nominal noise level is evaluated with  $L_{Aeq,T}$  value.

$L_{Aeq,T}$  (dB (A) re.  $20\mu\text{Pa}$ ) is the equivalent continuous A weighted sound pressure level, T greater than 15 seconds.

Results are to be given in global values (dB (A)) calculated in octave bands from 31,5 Hz to 8 kHz.

#### b) For vibration level

The criterion of vibration is to be expressed either in terms of overall frequency-weighted R.M.S. velocity (mm/s) from 1 to 80Hz as defined by ISO 20283-5, or single frequency amplitude peak velocity from 1 Hz to 100 Hz as defined by ISO 6954:1984 with a conversion factor  $C_F = 1$ , which leads to:

$$\text{crest factor} = C_F \times \sqrt{2}$$

$$\text{Maximum repetitive value} = \sqrt{2} \times \text{R.M.S. value}$$

#### c) For sound insulation

The criterion of sound insulation is to be expressed in terms of apparent weighted sound reduction index ( $R'w$ ) in dB, measured in accordance with ISO 16283-1 and then calculated in accordance with the method specified in ISO 717-1.

#### d) For impact noise

The criterion of impact noise is to be expressed in terms of weighted normalized impact sound pressure level ( $L'_{n,w}$ ) in dB, measured in accordance with ISO 16283-2 and then calculated in accordance with the method specified in ISO 717-2.

**2.1.4** When it is not possible for the Measurement Specialist to follow or to carry out all the required measurements, the specialist designated by the shipyard carries out the full measurement and spot-check is to be performed by the Measurement Specialist.

This spot-check consists of a cross-comparison between:

- a sample of at least 10% of the measurements provided by the shipyard/external specialist (see Note 1),
- and the corresponding readings obtained during the spot-check measurements.

This procedure enables the validation by the Society of the entire set of measurements provided by the shipyard/external specialist.

Note 1: The maximum deviations allowed during the cross-comparison are 2 dB(A) for noise measurements and 0,5 mm/s for vibration measurements for both single amplitude peak velocity and overall frequency weighted rms readings.

### 2.1.5 Measurement report

When the measurements are carried out by an approved service supplier, the measurement report is to be submitted to the Society for approval.

## 2.2 Determination of comfort rating number

**2.2.1** The notation is completed by a grade **1**, **2** or **3** which represents the comfort level achieved for the assignment of the notation, the grade 1 corresponding to the most comfortable (highest) class notation.

Regarding vibration, the notation is completed either by a grade **1**, **2** or **3** or by a grade **1PK**, **2PK** or **3PK** according to the vibration criteria used for the assessment.

**2.2.2** Levels are measured in several locations of each space of the ship. The granted comfort class grade is given on condition that none of the measured levels exceeds the corresponding requested limits.

A tolerance on noise levels may be accepted but shall not exceed the following maximum values:

- 3 dB(A) for 18% of all measured cabins and 5 dB(A) for 2% of all measured cabins (with a minimum of 1 cabin)
- 3 dB(A) for 25% of measuring points and 5 dB(A) for 5% of measuring points, in other spaces
- 1 dB for 20% of apparent weighted sound reduction indexes  $R'w$  and weighted normalized impact sound pressure level  $L'_{n,w}$  and 2 dB for 10% of apparent weighted sound reduction indexes  $R'w$  and weighted normalized impact sound pressure level  $L'_{n,w}$  (with a minimum of 1 partition or floor).

A tolerance on vibration levels may be accepted but shall not exceed the following maximum values:

- 0,3 mm/s for 20% of measuring points in all passenger and crew spaces for overall frequency weighted R.M.S. velocity criteria
- 0,5 mm/s for 20% of measuring points in all passenger and crew spaces for single amplitude peak velocity criteria.

## 2.3 Measuring locations

**2.3.1** The list of measuring points is to be prepared prior to the tests and submitted to the Society. This list may be adjusted during the tests and covers:

- noise level at harbour conditions (yacht only)
- noise level at sea conditions
- vibration level at sea conditions
- sound insulation measurements
- impact noise measurements.

## 3 Testing conditions

### 3.1 General

**3.1.1** This Article gives the conditions to be fulfilled during measurements. Additional details of these conditions may be taken from International Standards, respectively:

- IMO Resolution MSC.337(91), ISO 2923 for noise
- ISO 20283-5 and ISO 6954:1984 for vibrations.

**3.1.2** Prior to the tests, possible divergence on the required conditions may be accepted by the Society. If any, it is to be clearly mentioned in the report.

**3.1.3** The measurement program is to be submitted before the trials (see [1.5.1]). During the tests, some additional measurements may be decided upon request of the Measurement Specialist.

**3.1.4** During measurements, rooms have to be fully completed (outfitting, furniture, covering...).

## **3.2 Harbour test conditions**

**3.2.1** Part of the noise measurement tests is to be conducted at quay or at anchorage (impact noises and sound insulation indexes between rooms). For these specific tests, no particular conditions concerning output, loading conditions, water depth, weather conditions are required.

## **3.3 Sea trial conditions**

**3.3.1** During the sea trials, propeller output is to correspond to the specified open sea steady heading NCR (if not specified, at least 80% of MCR will be considered).

In particular, ships which are frequently operated by means of a Dynamic Positioning system (DP system) shall require additional measurements to be performed in DP mode. The Owner, Shipyard and Society shall agree on a process to simulate the operation of the DP thruster system under conditions which would approximate station-holding at, or above, 40 per cent of maximum thruster power for design environmental conditions that the ship operates in.

The list of machine and equipment to be run during the tests is, at least, to include (if present) the following:

- generating sets
- air conditioning and machinery ventilation
- evaporators

- anti rolling devices
- compressors and chillers
- cold rooms
- waste treatment units
- swimming pool with pumps
- jacuzzi and thalasso therapy equipment
- laundry with the entire equipment running.

**3.3.2** Any other frequently used equipment (more than 1/3 of the time at sea) is to be run at its normal operating conditions (if practicable).

**3.3.3** Standard test conditions correspond to the loading condition defined for sea trials. Nevertheless, for cargo ships which are operated over a wide range of drafts, the readings may significantly differ from test condition to another loading condition. Should this particular case occur, additional measurements may be required.

**3.3.4** Tests have to be conducted within sea and weather condition 3 or less. Measurements carried out with worst weather conditions may be accepted at the sight of the results.

**3.3.5** The tests have to be performed in deep water, with a water depth greater than 5 times the mean draft. However, for ships usually operating in coastal waters, measurements may be taken with conditions corresponding to normal service conditions.

**3.3.6** Ship course has to be kept constant, with rudder angle less than 2 degrees portside or starboard, for the duration of the measurement. If ship manoeuvring is needed, measurements must be stopped until recovery of steady heading.

## SECTION 2

# ADDITIONAL REQUIREMENTS FOR SHIPS OF LESS THAN 1600 GT

### 1 General

#### 1.1 Application

**1.1.1** The requirements of this Section are applicable to ships of less than 1600 GT. They are additional to the applicable requirements of Ch 6, Sec 1.

### 2 COMF-NOISE

#### 2.1 Measurement procedure

##### 2.1.1 Measuring conditions

Tests have to be conducted in the conditions described in Ch 6, Sec 1, [3.3]. Air conditioning is to be in normal operation. Doors and windows have to be closed, unless they have to be kept open in normal use.

It may happen that the measurements in accommodation spaces cannot be performed with HVAC in normal operation (as defined in Ch 6, Sec 1, [3.3]).

In such case, additional measurements should be done at quay and taken into account in the final results as follows:

$$LA_{eq} = 10 \cdot \text{Log}_{10} \left( 10^{\frac{LA_{eq1}}{10}} + 10^{\frac{LA_{eq2}}{10}} \right)$$

where:

**LA<sub>eq1</sub>** : Equivalent continuous A weighted sound pressure level measured at quay with HVAC in normal operation.

**LA<sub>eq2</sub>** : Equivalent continuous A weighted sound pressure level measured in sailing conditions without HVAC in normal operation.

##### 2.1.2 Measuring positions

###### a) Noise measurements

Measurements are to be taken at a height between 1,2 and 1,6 m from the deck and at a distance above 1,0 m from any boundary surface of the room. In cabins and offices, one measurement will be performed in the middle of the space. Additional measurements should be performed in other locations if appreciable sound level differences inside the room occur.

On open deck, measurements are to be taken at 2 m at least from the existing noise sources (e.g. inlet/outlet of ventilation).

Noise is to be measured in all accommodation spaces (cabins, public spaces, mess rooms and offices) in the wheelhouse, in the engine control room and in all work-

spaces specified in Tab 1, if any. On passenger ships having relatively large public rooms (salons or restaurants), noise measurements are to be carried out in different locations (to get a representative description of the noise), each measuring points covering less than 20 m<sup>2</sup>.

###### b) Sound insulation measurements

The selection of insulation measuring locations is to be representative of the different types of insulation provided in Tab 2 and Tab 3 (a minimum of two measurements of each type is required).

#### 2.2 Noise levels

**2.2.1** Noise levels corresponding to the noise grade **x** are provided in Tab 1.

#### 2.3 Sound insulation measurements

**2.3.1** Between two adjacent accommodation spaces, apparent weighted sound reduction index is to be greater than the requirements given in Tab 2 and Tab 3. Measurements are to be performed in situ, ship at quay or at anchorage.

### 3 COMF-VIB

#### 3.1 Measurement procedure

##### 3.1.1 Measuring conditions

Tests are to be conducted under the conditions described in Ch 6, Sec 1, [3.3].

##### 3.1.2 Measuring positions

Measurements are to be taken in vertical direction. In cabins, offices or other small size rooms, measurements are to be taken on the floor in the centre of the room. For larger rooms, several measuring points may be required.

Vibrations are to be measured in all accommodation spaces (cabins, public spaces and mess rooms, offices), in the wheelhouse, in the engine control room and in all workspaces specified in Tab 4, Tab 5 and Tab 6, if any. On passenger ships having relatively large public rooms (salons or restaurants), vibration measurements are to be carried out in different locations (to get a representative description of the vibration), each measuring points covering less than 20 m<sup>2</sup>.

In addition to vertical direction, measurements in transverse and longitudinal directions are to be performed on one point of each deck.

### 3.2 Vibration levels

**3.2.1** Vibration levels corresponding to the grade **x** are provided in Tab 4 in accordance to ISO 20283-5 (the limits listed below are applicable for any directions).

**3.2.2** Vibration levels corresponding to the grade **x** are provided in Tab 5 and Tab 6 in accordance to ISO 6954:1984 (the limits listed below are applicable for any directions).

**Table 1 : Noise level requirements**

Locations	LAeq,T in dB (A)		
	grade = 1	grade = 2	grade = 3
Wheelhouse	63	64	65
Passenger cabins	50	54	58
Crew cabins	55	58	60
Offices	60	63	65
Galleys (1)	72	73	75
Public spaces (type B), mess rooms (2)	60	63	65
Passages and type D spaces (2)	65	68	70
Engine control room or switchboard room (if continuously manned at sea) (1)	75	75	75
Open public areas (3) (4)	70	73	75
Workshops other than those forming part of machinery spaces (1)	85	85	85

(1) Equipment switched on but not processing.  
(2) For the definition of type A to type D public spaces, refer to Ch 6, Sec 1, [1.4.1].  
(3) Measurement carried out with a windscreen microphone protection.  
(4) A tolerance of 5 dB (A) may be accepted for measurements at less than 3 m from ventilation inlet/outlet.

**Table 2 : Apparent weighted sound reduction indexes R'w in dB for passenger areas**

Locations	grade = 1	grade = 2	grade = 3
Cabin to cabin	40	38	36
Corridor to cabin	38	36	34
Stairs to cabin	50	50	50
Public spaces to cabin	53	50	48

**Note 1:** When the area of the tested partition is less than 10 m<sup>2</sup>, a minimum value of 10 m<sup>2</sup> is to be considered for the calculation of index R'w.

**Table 3 : Apparent weighted sound reduction indexes R'w in dB for crew areas**

Locations	grade = 1	grade = 2	grade = 3
Cabin to cabin	37	35	32
Corridor to cabin	35	32	30
Stairs to cabin	35	32	30
Public spaces to cabin	45	44	42

**Note 1:** When the area of the tested partition is less than 10 m<sup>2</sup>, a minimum value of 10 m<sup>2</sup> is to be considered for the calculation of index R'w.

**Table 4 : Overall frequency weighted R.M.S. vibration levels**

Locations	Vibration velocity (mm/s) values from 1 Hz to 80 Hz		
	grade = 1	grade = 2	grade = 3
Wheelhouse	3,5	4,0	4,5
Passenger cabins	3,0	3,2	3,5
Crew cabins			
Offices	3,5	4,0	4,5
Galleys	5,0	5,5	6,0
Public spaces (type B), mess rooms (1)	3,0	3,2	3,5
Passages and type D spaces (1)	3,0	4,0	5,0
Engine control room or switchboard room (if continuously manned at sea)	4,0	4,5	5,0
Open public areas	3,5	4,0	4,5
Other workspaces	4,0	5,0	6,0

(1) For the definition of type A to type D public spaces, refer to Ch 6, Sec 1, [1.4.1].

**Table 5 : Single amplitude peak vibration levels from 5 Hz to 100 Hz**

Locations	Vibration velocity (mm/s peak) values from 5 Hz to 100 Hz		
	grade = 1PK	grade = 2PK	grade = 3PK
Wheelhouse	3	4	5
Passenger cabins	2	2,5	3
Crew cabins			
Offices	3	3,5	4
Galleys	5	5,5	6
Public spaces (type B), mess rooms <b>(1)</b>	3	3,5	4
Passages and type D spaces <b>(1)</b>			
Engine control room or switchboard room (if continuously manned at sea)	4	5	6
Open public areas	4	5	6
Other workspaces	4	5	6
<b>(1)</b> For the definition of type A to type D public spaces, refer to Ch 6, Sec 1, [1.4.1].			

**Table 6 : Single amplitude peak vibration levels from 1 Hz to 5 Hz**

Locations	Acceleration (mm/s <sup>2</sup> peak) values from 1 Hz to 5 Hz		
	grade = 1PK	grade = 2PK	grade = 3PK
Wheelhouse	96	125	157
Passenger cabins	64	80	96
Crew cabins			
Offices	96	111	125
Galleys	157	172	188
Public spaces (type B), mess rooms <b>(1)</b>	96	111	125
Passages and type D spaces <b>(1)</b>			
Engine control room or switchboard room (if continuously manned at sea)	125	157	188
Open public areas	125	157	188
Other workspaces	125	157	188
<b>(1)</b> For the definition of type A to type D public spaces, refer to Ch 6, Sec 1, [1.4.1].			

## SECTION 3

# ADDITIONAL REQUIREMENTS FOR SHIPS GREATER THAN OR EQUAL TO 1600 GT - CREW AREAS

### 1 General

#### 1.1 Application

1.1.1 The requirements of this Section are applicable to crew areas of ships greater than or equal to 1600 GT. They are additional to the applicable requirements of Ch 6, Sec 1.

### 2 COMF-NOISE

#### 2.1 Measurement procedure

##### 2.1.1 Measuring conditions

Tests are to be conducted in the conditions described in Ch 6, Sec 1, [3.3]. Air conditioning is to be in normal operation. Doors and windows are to be closed, unless they are to be kept open in normal use.

It may happen that the measurements in accommodation spaces cannot be performed with HVAC in normal operation (as defined in Ch 6, Sec 1, [3.3]).

In such case, additional measurements should be done at quay and taken into account in the final results as follows:

$$LA_{eq} = 10 \cdot \text{Log}_{10} \left( 10^{\frac{LA_{eq1}}{10}} + 10^{\frac{LA_{eq2}}{10}} \right)$$

where:

LA<sub>eq1</sub> : Equivalent continuous A weighted sound pressure level measured at quay with HVAC in normal operation.

LA<sub>eq2</sub> : Equivalent continuous A weighted sound pressure level measured in sailing conditions without HVAC in normal operation.

##### 2.1.2 Measuring positions

###### a) Noise measurements

Measurements are to be taken at a height between 1,2 and 1,6 m from the deck and at a distance above 1,0 m from any boundary surface of the room. In cabins and offices, one measurement will be performed in the middle of the space. Additional measurements should be performed in other locations if appreciable sound level differences inside the room occur.

On open deck, measurements are to be taken at 2,0 m at least from the existing noise sources (e.g. inlet/outlet of ventilation).

Measurements are to be carried out in a minimum of 60% of the rooms on each cabins deck (including hospital). When the engine casing is integrated in the accommodation area, noise levels are to be measured in each adjacent room.

For the location and number of measuring points in crew cabins within passenger ships, refer to Ch 6, Sec 4.

In addition, noise is to be measured in all workspaces and public spaces specified in Tab 2 and Tab 3. In the wheelhouse, three points are to be measured (centre line and both sides).

For large rooms exceeding 20 m<sup>2</sup> (mess rooms, recreation rooms...), noise measurements are to be performed every 20 m<sup>2</sup>.

###### b) Sound insulation measurements

The selection of sound insulation measuring locations is to be representative of the different types of insulation provided in Tab 1 (a minimum of two measurements of each type is required).

#### 2.2 Noise levels

2.2.1 Noise levels corresponding to the noise grade **x** are provided in Tab 2 or Tab 3, as applicable.

#### 2.3 Sound insulation measurements

2.3.1 Between two adjacent accommodation spaces, apparent weighted sound reduction index R'<sub>w</sub> is to be greater than the requirements given in Tab 1. Measurements are to be performed in situ, ship at quay or at anchorage.

**Table 1 : Apparent weighted sound reduction indexes R'<sub>w</sub> in dB**

Locations	grade = 1	grade = 2	grade = 3
Cabin to cabin	37	35	32
Corridor to cabin	35	32	30
Stairs to cabin	35	32	30
Public spaces to cabin	45	44	42

**Note 1:** When the area of the tested partition is less than 10 m<sup>2</sup>, a minimum value of 10 m<sup>2</sup> is to be considered for the calculation of index R'<sub>w</sub>.

**Table 2 : Noise level requirements for ships from 1600 GT to 10000 GT**

Locations	LAeq,T in dB (A)		
	grade = 1	grade = 2	grade = 3
Wheelhouse	60	63	65
Radio room (1)	55	57	60
Cabins	52	55	60
Offices	57	60	65
Public spaces, mess rooms	57	60	65
Hospital	56	58	60
Engine control room or switchboard room (if continuously manned at sea) (2)	70	73	75
Open recreation areas (3) (4)	70	73	75
Galleys (2)	72	72	75
Workshops other than those forming part of machinery spaces (2)	85	85	85
Staircases and passages in crew areas	70	73	75
(1) Equipment switched on but not emitting. (2) Equipment switched on but not processing. (3) Measurement carried out with a windscreen microphone protection. (4) A tolerance of 5 dB (A) may be accepted for measurements at less than 3 m from ventilation inlet/outlet.			

**Table 3 : Noise level requirements for ships greater than 10000 GT**

Locations	LAeq,T in dB (A)		
	grade = 1	grade = 2	grade = 3
Wheelhouse	60	63	65
Radio room (1)	55	57	60
Cabins	50	52	55
Offices	55	57	60
Public spaces, mess rooms	55	57	60
Hospital	53	54	55
Engine control room or switchboard room (if continuously manned at sea) (2)	70	73	75
Open recreation areas (3) (4)	70	73	75
Galleys (2)	72	72	75
Workshops other than those forming part of machinery spaces (2)	85	85	85
Staircases and passages in crew areas	70	73	75
(1) Equipment switched on but not emitting. (2) Equipment switched on but not processing. (3) Measurement carried out with a windscreen microphone protection. (4) A tolerance of 5 dB (A) may be accepted for measurements at less than 3 m from ventilation inlet/outlet.			

### 3 COMF-VIB

#### 3.1 Measurement procedure

##### 3.1.1 Measuring conditions

Tests are to be conducted under the conditions described in Ch 6, Sec 1, [3.3].

##### 3.1.2 Measuring positions

Measurements are to be taken in vertical direction. In cabins, offices or other small size rooms, measurements are to be taken on the floor in the centre of the room. For larger rooms, several measuring points may be required.

Measurements are to be carried out in a minimum of 60% of the rooms on each cabins deck (including hospital).

For the location and number of measuring points in crew cabins within passenger ships, refer to Ch 6, Sec 4.

Vibrations are to be measured in all workspaces and public spaces specified in Tab 4, Tab 5 or Tab 6. In the wheelhouse, three points are to be measured (centre line and both sides).

In addition to vertical direction, measurements in transverse and longitudinal directions are to be performed on one point on each deck.

#### 3.2 Vibration levels

**3.2.1** Vibration levels corresponding to the vibration grade **x** are provided in Tab 4 in accordance to ISO 20283-5 (the limits listed below are applicable for any directions).

**3.2.2** Vibration levels corresponding to the vibration grade **x** are provided in Tab 5 and Tab 6 in accordance to ISO 6954:1984 (the limits listed below are applicable for any directions).

**Table 4 : Overall frequency weighted r.m.s vibration levels**

Locations	Vibration velocity (mm/s) values from 1 Hz to 80 Hz		
	grade = 1	grade = 2	grade = 3
Wheelhouse	2,8	3,0	3,2
Radio room			
Cabins	2,8	3,0	3,2
Offices	3,0	3,5	4,0
Public spaces, mess rooms	3,0	3,2	3,5
Hospital	2,8	3,0	3,2
Engine control room or switchboard room (if continuously manned at sea)	4,0	4,5	5,0
Open recreation areas	–	–	–
Galleys	5,0	5,5	6,0
Workspaces			
Staircases and passages in crew areas	5,0	5,5	6,0

**Table 5 : Single amplitude peak vibration levels from 5 Hz to 100 Hz**

Locations	Vibration velocity (mm/s peak) values from 5 Hz to 100 Hz		
	grade = 1PK	grade = 2PK	grade = 3PK
Wheelhouse	2,0	3,0	4,0
Radio room			
Cabins	3,0	3,5	4,0
Offices	3,0	4,0	5,0
Public spaces, mess rooms	3,0	3,5	4,0
Hospital	2,0	3,0	4,0
Engine control room or switchboard room (if continuously manned at sea)	4,0	4,5	5,0
Open recreation areas	–	–	–
Galleys	5,0	5,5	6,0
Workspaces			
Staircases and passages in crew areas	5,0	5,5	6,0

**Table 6 : Single amplitude peak vibration levels from 1 Hz to 5 Hz**

Locations	Acceleration (mm/s <sup>2</sup> peak) values from 1 Hz to 5 Hz		
	grade = 1PK	grade = 2PK	grade = 3PK
Wheelhouse	96	103	111
Radio room			
Cabins	89	96	100
Offices	96	111	125
Public spaces, mess rooms	96	111	125
Hospital	89	96	125
Engine control room or switchboard room (if continuously manned at sea)	125	141	157
Open recreation areas	–	–	–
Galleys	157	172	188
Workspaces			
Staircases and passages in crew areas	157	172	188



## SECTION 4

# ADDITIONAL REQUIREMENTS FOR SHIPS GREATER THAN OR EQUAL TO 1600 GT - PASSENGER AREAS

### 1 General

#### 1.1 Application

**1.1.1** The requirements of this Section are applicable to passenger areas of ships greater than or equal to 1600 GT. They are additional to the applicable requirements of Ch 6, Sec 1.

### 2 COMF-NOISE

#### 2.1 Measurement procedure

##### 2.1.1 Measuring conditions

Tests have to be conducted in the conditions described in Ch 6, Sec 1, [3.3]. Air conditioning is to be in normal operation. Doors and windows have to be closed, unless they have to be kept open in normal use.

It may happen that the measurements in accommodation spaces cannot be performed with HVAC in normal operation (as defined in Ch 6, Sec 1, [3.3]).

In such case, additional measurements should be done at quay and taken into account in the final results as follows:

$$LA_{eq} = 10 \cdot \text{Log}_{10} \left( 10^{\frac{LA_{eq1}}{10}} + 10^{\frac{LA_{eq2}}{10}} \right)$$

where:

**LA<sub>eq1</sub>** : Equivalent continuous A weighted sound pressure level measured at quay with HVAC in normal operation.

**LA<sub>eq2</sub>** : Equivalent continuous A weighted sound pressure level measured in sailing conditions without HVAC in normal operation.

##### 2.1.2 Measuring positions

###### a) Noise measurements

Measurements are to be taken at a height between 1,2 and 1,6 m from the deck and at a distance above 1,0 m from any boundary surface of the room. In cabins and offices, one measurement will be performed in the mid-

dle of the space. Additional measurements should be performed in other locations if appreciable sound level differences inside the room occur.

On open decks, measurements are to be taken at 2,0 m at least from the existing noise sources (e.g. inlet/outlet of ventilation).

In cabins, measurements are to be carried out at the centre of the cabin.

In order to define the location and number of measuring points, the length of the ship is divided in two parts:

- From the aft part of the ship to the front bulkhead of the casing:
  - minimum of 35% of cabins
  - all public spaces and open decks.

For large public rooms (lounges, restaurants...) measurements are to be carried out in different locations, each measuring point covering less than 50 m<sup>2</sup>.

- From the front bulkhead of the casing to the fore end of the ship:
  - minimum of 15% of cabins
  - all public spaces and open decks.

For large public rooms (lounges, restaurants...) measurements are to be carried out in different locations, each measuring point covering less than 100 m<sup>2</sup>.

Note 1: The Society may accept a lower number of measuring points or a modification of the points distribution for specific cases.

Note 2: The number of measuring points should not exceed 250.

###### b) Sound insulation measurements

The selection of insulation measuring locations is to be representative of the different types of insulation provided in Tab 1 (a minimum of two measurements of each type is required).

###### c) Impact measurements

The selection of impact measuring locations is to be representative of the different deck coverings implemented on the ship and as provided in Tab 2 (a minimum of two measurements of each deck covering is required). These measurements are dedicated to passenger cabins only.

## 2.2 Noise levels

**2.2.1** Noise levels corresponding to the noise grade **x** are provided in Tab 3.

## 2.3 Sound insulation measurements

**2.3.1** Between two adjacent accommodation spaces, acoustic insulation is to be greater than the requirements given in Tab 1. Measurements are to be performed in situ, ship at quay or at anchorage.

## 2.4 Impact measurements

**2.4.1** For cabins below public spaces, the weighted normalized impact sound pressure level is to be lower than the requirements given in Tab 2. Measurements are to be performed in situ, ship at quay or at anchorage.

**Table 1 : Apparent weighted sound reduction indexes R'w in dB**

Locations	grade = 1	grade = 2	grade = 3
Cabin to cabin (top level)	45	42	40
Cabin to cabin (standard)	41	38	36
Cabin to cabin with communication door (top level)	44	41	39
Cabin to cabin with communication door (standard)	40	37	35
Corridor to cabin (top level)	42	40	37
Corridor to cabin (standard)	38	36	34
Stairs to cabin	48	45	45
Public spaces to cabin	53	50	48
Discotheques and show rooms to cabin	64	62	60
<b>Note 1:</b> When the area of the tested partition is less than 10 m <sup>2</sup> , a minimum value of 10 m <sup>2</sup> is to be considered for the calculation of index R'w.			

**Table 2 : Weighted normalized impact sound pressure level L'n,w**

Locations	L'n,w in dB
Cabin below public spaces covered with soft materials	50
Cabin below public spaces covered with hard materials (wood, marble, tiles, etc)	60
Cabin below sport rooms or dance floors	45

## 3 COMF-VIB

### 3.1 Measurement procedure

#### 3.1.1 Measuring conditions

Tests are to be conducted under the conditions described in Ch 6, Sec 1, [3.3].

#### 3.1.2 Measuring positions

Measurements are to be taken in vertical direction. In cabins, offices or other small size rooms, measurements are to be taken on the floor in the centre of the room. For larger rooms, several measuring points may be required.

In order to define the location and number of measuring points, the length of the ship is divided in two parts:

- From the aft part of the ship to the front bulkhead of the casing:
  - minimum of 20% of cabins
  - all public spaces and open decks.

For large public rooms (lounges, restaurants, ...) measurements are to be carried out in different locations, each measuring point covering less than 80 m<sup>2</sup>.

- From the front bulkhead of the casing to the fore end of the ship:
  - minimum of 10% of cabins
  - all public spaces and open decks.

For large public rooms (lounges, restaurants, ...) measurements are to be carried out in different locations, each measuring point covering less than 150 m<sup>2</sup>.

Note 1: The Society may accept a lower number of measuring points or a modification of the points distribution for specific cases.

Note 2: The number of measuring points should not exceed 250.

In addition to vertical direction, measurements in transverse and longitudinal directions are to be performed every 3 decks, with one measuring point in the fore part of the ship, one in the middle part and one in the aft part.

### 3.2 Vibration levels

**3.2.1** Vibration levels corresponding to the vibration grade **x** are provided in Tab 5 in accordance to ISO 20283-5 (the limits listed below are applicable for any directions).

**3.2.2** Vibration levels corresponding to the vibration grade **x** are provided in Tab 6 and Tab 4 in accordance to ISO 6954:1984 (the limits listed below are applicable for any directions).

Table 3 : Noise level requirements

Locations	LAeq,T in dB (A)		
	grade = 1	grade = 2	grade = 3
Passenger top level cabins	45	47	50
Passenger standard cabins	49	52	55
Restaurants, cafeterias and type B spaces (1)	55	57	60
Public shop, passages (type D) (1)	60	63	65
Passenger spaces (type A) (1)	65	68	72
Passenger spaces (type C) (1)	53	56	59
Outside installations (swimming pools, sport decks...) (2) (3)	65	70	75
Beauty center and spas (massage parlor, rest room, hairdressing salon, ...) (4)	53	56	59

(1) For the definition of type A to type D public spaces, refer to Ch 6, Sec 1, [1.4.1].  
(2) A tolerance of 5 dB (A) may be accepted for measurements at less than 3 m from ventilation inlet/outlet.  
(3) Measurement carried out with a windscreen microphone protection.  
(4) Equipment not processing.

Table 4 : Single amplitude peak vibration levels from 1 Hz to 5 Hz

Locations	Acceleration (mm/s <sup>2</sup> peak) values from 1 Hz to 5 Hz		
	grade = 1PK	grade = 2PK	grade = 3PK
Passenger top level cabins	48	64	80
Passenger standard cabins	64	80	96
Restaurants, cafeterias and type B spaces (1)	80	96	111
Public shops, passages (type D) (1)	125	125	125
Passenger spaces (type A) (1)			
Passenger spaces (type C) (1)	64	80	96
Outside installations (swimming pools, sport decks, ...)	96	125	125
Beauty center and spas (massage parlor, rest room, hairdressing salon, ...) (2)	64	80	96

(1) For the definition of type A to type D public spaces, refer to Ch 6, Sec 1, [1.4.1].  
(2) Equipment not processing.

Table 5 : Overall frequency weighted R.M.S. vibration levels

Locations	Vibration velocity (mm/s) values from 1 Hz to 80 Hz		
	grade = 1	grade = 2	grade = 3
Passenger top level cabins	1,7	2	2,2
Passenger standard cabins	2,0	2,5	3,0
Restaurants, cafeterias and type B spaces (1)	2,2	2,5	3,0
Public shops, passages (type D) (1)	4,0	4,5	5,0
Passenger spaces (type A) (1)			
Passenger spaces (type C) (1)	2,0	2,5	3,0
Outside installations (swimming pools, sport decks, ...)	3,0	3,5	4,0
Beauty center and spas (massage parlor, rest room, hairdressing salon, ...) (2)	2,0	2,5	3,0

(1) For the definition of type A to type D public spaces, refer to Ch 6, Sec 1, [1.4.1].  
(2) Equipment not processing.

**Table 6 : Single amplitude peak vibration levels from 5 Hz to 100 Hz**

Locations	Vibration velocity (mm/s peak) values from 5 Hz to 100 Hz		
	grade = 1PK	grade = 2PK	grade = 3PK
Passenger top level cabins	1,5	2,0	2,5
Passenger standard cabins	2,0	2,5	3,0
Restaurants, cafeterias and type B spaces <b>(1)</b>	2,5	3,0	3,5
Public shops, passages (type D) <b>(1)</b>	4,0	4,0	4,0
Passenger spaces (type A) <b>(1)</b>			
Passenger spaces (type C) <b>(1)</b>	2,0	2,5	3,0
Outside installations (swimming pools, sport decks, ...)	3,0	4,0	4,0
Beauty center and spas (massage parlor, rest room, hairdressing salon, .) <b>(2)</b>	2,0	2,5	3,0
<b>(1)</b> For the definition of type A to type D public spaces, refer to Ch 6, Sec 1, [1.4.1].			
<b>(2)</b> Equipment not processing.			

## SECTION 5

## ADDITIONAL REQUIREMENTS FOR YACHTS

### 1 General

#### 1.1 Application

1.1.1 The requirements of this Section are applicable to yachts. They are additional to the applicable requirements of Ch 6, Sec 1.

### 2 COMF-NOISE

#### 2.1 Measurement procedure

##### 2.1.1 Measuring conditions

For noise level measurements in harbour conditions, machinery and chiller should be run under normal harbour conditions. HVAC and machinery ventilation must be in operation and at nominal rate all over the ship.

Tests in sea trial conditions are to be conducted in the conditions described in Ch 6, Sec 1, [3.3]. Air conditioning is to be in normal operation. Doors and windows are to be closed, unless they are to be kept open in normal use.

It may happen that the measurements in accommodation spaces cannot be performed with HVAC in normal operation (as defined in Ch 6, Sec 1, [3.3]).

In such case, additional measurements should be done at quay and taken into account in the final results as follows:

$$LA_{eq} = 10 \cdot \text{Log}_{10} \left( 10^{\frac{LA_{eq1}}{10}} + 10^{\frac{LA_{eq2}}{10}} \right)$$

where:

LA<sub>eq1</sub> : Equivalent continuous A weighted sound pressure level measured at quay with HVAC in normal operation.

LA<sub>eq2</sub> : Equivalent continuous A weighted sound pressure level measured in sailing conditions without HVAC in normal operation.

##### 2.1.2 Measuring positions

###### a) Noise measurements

Measurements are to be taken at a height between 1,2 and 1,6 m from the deck and at a distance above 1,0 m from any boundary surface of the room. In cabins and offices, one measurement will be performed in the middle of the space. Additional measurements should be performed in other locations if appreciable sound level differences inside the room occur.

On open deck, measurements are to be taken at 2,0 m at least from the existing noise sources (e.g. inlet/outlet of ventilation).

The noise measurements are to be performed in all crew and passenger spaces, each measuring point covering less than 15 m<sup>2</sup>.

###### b) Sound insulation measurements

The selection of insulation measuring locations is to be representative of the different types of insulation provided in Tab 1 and Tab 2 (a minimum of two measurements of each type is required).

###### c) Impact measurements

The selection of impact measuring locations is to be representative of the different deck coverings implemented on the ship (a minimum of two measurements of each deck covering is required).

These measurements are dedicated to passenger cabins only.

#### 2.2 Noise levels

2.2.1 Noise levels corresponding to the noise grade x are provided in Tab 3.

#### 2.3 Sound insulation measurements

2.3.1 Between two adjacent accommodation spaces, acoustic insulation is to be greater than the requirements given in Tab 1 and Tab 2. Measurements are to be performed in situ, ship at quay or at anchorage.

**Table 1 : Apparent weighted sound reduction indexes R<sup>1</sup>w in dB for passenger areas**

Locations	grade = 1	grade = 2	grade = 3
Cabin to cabin	45	42	40
Corridor to cabin	42	40	37
Stairs to cabin	48	45	45
Public spaces to cabin	55	53	50
Public spaces designed for loud music to cabin	64	62	60

**Note 1:** When the area of the tested partition is less than 10 m<sup>2</sup>, a minimum value of 10 m<sup>2</sup> is to be considered for the calculation of index R<sup>1</sup>w.

**Table 2 : Apparent weighted sound reduction indexes R<sup>1</sup>w in dB for crew areas**

Locations	grade = 1	grade = 2	grade = 3
Cabin to cabin	37	35	32
Corridor to cabin	35	32	30
Stairs to cabin	35	32	30
Public spaces to cabin	45	45	45

**Note 1:** When the area of the tested partition is less than 10 m<sup>2</sup>, a minimum value of 10 m<sup>2</sup> is to be considered for the calculation of index R<sup>1</sup>w.

**Table 3 : Noise level requirements**

Locations	L <sub>Aeq,T</sub> in dB (A)					
	Harbour			Sea		
	grade = 1	grade = 2	grade = 3	grade = 1	grade = 2	grade = 3
Wheelhouse	–	–	–	65	65	65
Passengers cabins	40	45	50	50	54	58
Lounges	45	50	55	55	58	62
Open recreation areas (1)	55	60	65	75	80	85
Crew cabins	45	50	55	55	58	60
Public spaces (type B), mess rooms (2)	55	58	60	60	63	65
Passages and type D spaces (2)	60	63	65	65	68	72

(1) Measurement carried out with a windscreen microphone protection.  
(2) For the definition of type A to type D public spaces, refer to Ch 6, Sec 1, [1.4.1].

## 2.4 Impact measurements

**2.4.1** For cabins below public spaces, impact noise index is to be lower than the requirements given in Tab 4. Measurements are to be performed in situ, ship at quay or at anchorage.

**Table 4 : Weighted normalized impact sound pressure level**

Locations	L' <sub>n,w</sub> in dB
Cabin below public spaces covered with soft materials	50
Cabin below public spaces covered with hard materials (wood, marble, tiles, etc)	60
Cabin below sport rooms or dance floors	45

## 3 COMF-VIB

### 3.1 Measurement procedure

#### 3.1.1 Measuring conditions

Tests are to be conducted under the conditions described in Ch 6, Sec 1, [3.3].

#### 3.1.2 Measuring positions

Measurements are to be taken in vertical direction. In cabins, offices or other small size rooms, measurements are to be taken on the floor in the centre of the room. For larger rooms, several measuring points may be required.

Measurements are to be performed in all crew and passenger spaces, each measuring point covering less than 15 m<sup>2</sup>.

In addition to vertical direction, measurements in transverse and longitudinal directions are to be performed on one point on each deck.

### 3.2 Vibration levels

**3.2.1** Vibration levels corresponding to the vibration grade x are provided in Tab 5 in accordance to ISO 20283-5 (the limits listed below are applicable for any directions).

**3.2.2** Vibration levels corresponding to the vibration grade x are provided in Tab 6 and Tab 7 in accordance to ISO 6954:1984 (the limits listed below are applicable for any directions).

**Table 5 : Overall frequency weighted r.m.s vibration levels**

Locations	Vibration velocity (mm/s) values from 1 Hz to 80 Hz					
	Harbour			Sea		
	grade = 1	grade = 2	grade = 3	grade = 1	grade = 2	grade = 3
Wheelhouse	–	–	–	2,5	3,5	4,5
Passengers cabins	1,0	1,5	2,0	2,0	2,5	3,0
Lounges	1,0	1,5	2,0	2,0	2,5	3,0
Open recreation areas	2,0	2,5	3,0	3,0	4,0	4,5
Crew cabins	2,0	2,5	3,0	2,5	3,0	3,5
Public spaces (type B), mess rooms (1)	2,0	2,5	3,0	2,5	3,0	3,5
Passages and type D spaces (1)	2,0	3,0	4,0	3,0	4,0	5,0

(1) For the definition of type A to type D public spaces, refer to Ch 6, Sec 1, [1.4.1].

**Table 6 : Single amplitude peak vibration levels from 5 Hz to 100 Hz**

Locations	Vibration velocity (mm/s peak) values from 5 Hz to 100 Hz					
	Harbour			Sea		
	grade = 1PK	grade = 2PK	grade = 3PK	grade = 1PK	grade = 2PK	grade = 3PK
Wheelhouse	–	–	–	2,5	3,5	5,0
Passengers cabins	1,0	1,5	2,5	2,0	2,5	3,0
Lounges	1,0	1,5	2,5	3,0	3,5	4,0
Open recreation areas	2,0	3,0	4,0	3,5	4,5	5,0
Crew cabins	1,5	2,0	2,5	2,0	2,5	3,0
Public spaces (type B), mess rooms (1)	2,0	2,5	3,0	3,0	3,5	4,0
Passages and type D spaces (1)	2,0	3,0	4,0	3,0	4,0	5,0

(1) For the definition of type A to type D public spaces, refer to Ch 6, Sec 1, [1.4.1].

**Table 7 : Single amplitude peak vibration levels from 1 Hz to 5 Hz**

Locations	Acceleration (mm/s <sup>2</sup> peak) values from 1 Hz to 5 Hz					
	Harbour			Sea		
	grade = 1PK	grade = 2PK	grade = 3PK	grade = 1PK	grade = 2PK	grade = 3PK
Wheelhouse	–	–	–	80	111	144
Passengers cabins	32	48	80	64	80	96
Lounges	32	48	80	96	111	125
Open recreation areas	64	96	125	111	144	157
Crew cabins	48	64	78	64	80	96
Public spaces (type B), mess rooms (1)	64	80	96	96	111	128
Passages and type D spaces (1)	64	96	125	96	125	157

(1) For the definition of type A to type D public spaces, refer to Ch 6, Sec 1, [1.4.1].

## 4 COMF +

### 4.1 Application

**4.1.1** Optional **COMF +** notation represents an advanced comfort rating with additional performance index requirements.

Note 1: The present Article may also be applied, after special study, to passenger ships.

**4.1.2** Prior to the **COMF+** notation assessment, **COMF-NOISE** notation is to be granted.

**4.1.3** The following **COMF+** performance indexes can be granted separately:

- **COMF+** Sound insulation index
- **COMF+** Impact index
- **COMF+** Emergence
- **COMF+** Intermittent noise
- **COMF+** Intelligibility.

### 4.2 Data processing and analysis

**4.2.1** Results are to be given on a table in global values (dB(A) or dB for insulation measurements).

## 4.3 Measurement procedure

### 4.3.1 Measuring conditions

Tests are to be conducted in the conditions described in Ch 6, Sec 1, [3.3] and [2.1.1].

Specific additional conditions are described in the relevant **COMF+** index requirements.

### 4.3.2 Measuring positions

The location of the measuring positions is selected in accordance with [2.1.2] for the following indexes:

- **COMF+** Sound insulation index
- **COMF+** Impact index
- **COMF+** Emergence.

## 4.4 COMF + Sound insulation index

### 4.4.1 Sound insulation between discotheques, show lounge and passenger cabins

Due to the potential low frequency noise, transmitted through floors or bulkheads, the sound insulation index requirement is to be considered as the sum of the R<sub>w</sub> index + the adaptation term C as described in ISO 717-1.

The adaptation term C added to the R<sub>w</sub> index is to be above the insulation level given in Tab 8.

**Table 8 : Sound insulation indexes R<sub>w</sub>+C**

Locations	grade = 1	grade = 2	grade = 3
Discotheques and show rooms to cabin	64	62	59

#### 4.5 COMF + Impact index

**4.5.1** Due to the potential low frequency noise, transmitted through the floor, the impact noise index requirement is to be considered as the sum of the L<sub>n,w</sub> index + the adaptation term C<sub>i</sub> as described in ISO 717-2.

The adaptation term C<sub>i</sub> added to the L<sub>n,w</sub> index is to be below any impact comfort class requirements listed in [2.4.1].

#### 4.6 COMF + Emergence

**4.6.1** When the noise level contains audible annoying tonal components, an objective assessment should be carried out as described in ISO 1996-2:2007 Annex D.

A prominent tone in one-third-octave band is established when its level exceeds the time-average sound pressure levels of both adjacent one-third-octave bands by some constant level difference.

The constant level difference varies with the frequency and shall not exceed:

- 15 dB in the low-frequency one-third-octave bands (25 Hz to 125 Hz)
- 8 dB in middle-frequency bands (160 Hz to 400 Hz)
- 5 dB in high-frequency bands (500 Hz to 10 000 Hz).

#### 4.7 COMF + intermittent noise

**4.7.1** Machinery and systems having an intermittent operation are not to increase the noise level in cabins, with regard to ambient noise, by more than 5 dB(A) during day-time (from 7 am to 10 pm) and 3 dB(A) during night time (from 10 pm to 7 am).

**4.7.2** The shipyard is to propose an intermittent noise measuring program including:

- the complete procedure of measurements
- the exhaustive list of system which includes, when applicable:
  - swimming pool/Jacuzzi equipment and piping during filling/emptying/re-circulating
  - dishwasher/pulper
  - high pressure deck washing piping systems
  - hydraulic power pack
  - evaporators
  - stabiliser systems
  - steam dump valve
  - laundry/garbage equipment
- the ambient noise considered for each system (i.e. noise at quay or at sea conditions).

Anchoring, mooring, thrusters, safety alarms, emergency equipment are excluded from the list of machinery systems concerned by this paragraph.

This program is to be submitted to the Society prior to the trials.

#### 4.8 COMF + intelligibility

**4.8.1** In spaces with audience expected, like theatres, conference rooms, etc..., the STIPA (Speech Transmission Index for Public Address system) is to be above 0,60 (for each public space, measurements are to be carried out in different locations, each measuring point covering less than 40 m<sup>2</sup>).

The Society may accept a lower number of measuring points or a modification of the point distribution for specific cases.

Note 1: The evaluation of the STIPA has been standardised in IEC 60268-16.

**4.8.2** For other specified spaces, the reverberation time (RT), in seconds, is to be lower than the requirements of:

- Tab 9 for restaurants, bars, lounges and casinos
- Tab 10 for cabins, lecture rooms and libraries.

**4.8.3** An Intelligibility noise measuring program is to be submitted to the Society, prior to measurement test.

**Table 9 : Reverberation time requirements for restaurants, bars, lounges and casinos**

Volume V, in m <sup>3</sup>	RT, in s
V ≤ 50	0,50
50 < V ≤ 100	0,60
100 < V ≤ 200	0,70
200 < V ≤ 500	0,80
500 < V ≤ 1000	0,90
1000 < V ≤ 2000	1,00
2000 < V ≤ 3000	1,10
V > 3000	1,20

**Table 10 : Reverberation time requirements for cabins, lecture rooms and libraries**

Volume V, in m <sup>3</sup>	RT, in s
V ≤ 50	0,45
50 < V ≤ 100	0,50
100 < V ≤ 200	0,55
200 < V ≤ 500	0,60
500 < V ≤ 1000	0,70
1000 < V ≤ 2000	0,80
V > 2000	0,90



Part F  
**Additional Class Notations**

Chapter 7

**REFRIGERATING INSTALLATIONS (REF)**

---

- SECTION 1      GENERAL REQUIREMENTS**
- SECTION 2      ADDITIONAL REQUIREMENTS FOR NOTATION REF-CARGO**
- SECTION 3      ADDITIONAL REQUIREMENTS FOR NOTATION REF-CONT**
- SECTION 4      ADDITIONAL REQUIREMENTS FOR NOTATION REF-STORE**



## SECTION 1

## GENERAL REQUIREMENTS

### 1 General

#### 1.1 Application

**1.1.1** The following additional class notations are assigned, in accordance with Pt A, Ch 1, Sec 2, [6.9], to ships with refrigerating installations complying with the applicable requirements of this Chapter:

- **REF-CARGO** for installations related to carriage of cargo
- **REF-CONT** for installations related to carriage of containers
- **REF-STORE** for installations related to preservation of ship's domestic supplies.

**1.1.2** The requirements of this Chapter apply to refrigerating installations on ships, and include the fixed plants for refrigerating holds of cargo ships, fishing and factory ships, fruit and juice carrier ships, etc., refrigerated containers, various ship's services, such as air conditioning, galleys, etc. These requirements are specific to permanently installed refrigerating installations and associated arrangements and are to be considered additional to those specified in Pt C, Ch 1, Sec 13, which are mandatory for all ships with refrigerating installations.

**1.1.3** The notations given in [1.1.1] may be completed by the following:

- **PRECOOLING** for refrigerating plants designed for ensuring within a suitable time interval the cooling down of a complete cargo of fruit or vegetables to the required temperature of transportation
- **QUICKFREEZE** for refrigerating plants of fishing vessels and fish factory ships where the design and equipment of such plants have been recognised as suitable to permit quick-freezing of fish in specified conditions.

The notations **REF-CARGO** and **REF-CONT** may be completed by **AIRCONT** for ships fitted with a controlled atmosphere plant on board.

**1.1.4** The notations **REF-CONT** may be completed by **(A)** or **(E)** as defined in Ch 7, Sec 3, [1.1.2].

#### 1.2 Temperature conditions

##### 1.2.1 Cargo space conditions

The minimum internal temperature or the temperature range for which the notation is granted is to be mentioned in the notation. For design temperatures to be considered for designing the plant, see [2.1.1] and [2.1.2].

This indication is to be completed by the mention of any operational restriction such as maximum sea water temperature, geographical or seasonal limitations, etc., as applicable.

##### 1.2.2 Container conditions

For refrigerating plants on board container ships complying with the provisions of Ch 7, Sec 3, in addition to the data listed in [1.2.1], the notation is to specify the maximum number of containers liable to be served, and the value of their heat transfer coefficient

$k$  : in  $W/(m^2 \text{ } ^\circ C)$ , or

$U$  :  $k S$ , in  $W/^\circ C$ ,

where  $S$  is the surface through which the heat is transferred, in  $m^2$ , as determined by type tests.

#### 1.3 Definitions

##### 1.3.1 Direct cooling system

Direct cooling system is the system by which the refrigeration is obtained by direct expansion of the refrigerant in coils fitted on the walls and ceilings of the refrigerated chambers.

##### 1.3.2 Indirect cooling system

Indirect cooling system is the system by which the refrigeration is obtained by brine or other secondary refrigerant, which is refrigerated by a primary refrigerant, circulated through pipe grids or coils fitted on the walls and ceilings of the refrigerated chambers.

##### 1.3.3 Air cooling system

Direct air cooling system is the system by which the refrigeration is obtained by circulation of air refrigerated by an air cooler.

##### 1.3.4 Refrigerant

Refrigerant is a cooling medium which is used to transmit and maintain the cool in the refrigerated chamber.

##### 1.3.5 Brine

Brine is a refrigerant constituted by a solution of industrial salts, which is normally used to cool the chambers in the indirect cooling systems, as secondary refrigerant. In general, in this Chapter, the word brine is also used to cover other types of secondary refrigerants, as for instance refrigerants based on glycol.

##### 1.3.6 Refrigerating unit

A refrigerating unit includes one or more compressors driven by one or more prime movers, one condenser and all the associated ancillary equipment necessary to form an independent gas-liquid system capable of cooling refrigerated chambers.

When the installation includes a secondary refrigerant (brine), the refrigerating unit is also to include a brine cooler (evaporator) and a pump.

### 1.3.7 Refrigerated chamber

A chamber is any space which is refrigerated by a refrigerating unit. A chamber may be a cargo space or any other ship service space, such as for instance the galley.

## 2 Design criteria

### 2.1 Reference conditions

#### 2.1.1 Design temperature

Unless otherwise indicated in the specification, refrigerating plants are to be designed for the following design temperatures:

- Frozen cargo: minus 20°C
- Fish: minus 20°C
- Fruit: 0°C
- Bananas: 12°C.

#### 2.1.2 Environmental conditions

Unless otherwise indicated in the ship specification, the following environmental conditions are to be considered for the heat transfer and balance calculations and for the running rate of the refrigerating machinery:

- Sea water temperature: 32°C
- Outside air temperature: 35°C
- Relative humidity of air at 35°C: 80%.

For the determination of heat transfer through outside walls liable to be exposed to sun radiation, the outside air temperature is to be taken as equal to 45°C.

#### 2.1.3 Operating conditions

The refrigerating plant inclusive of all machinery, equipment and accessories is to operate satisfactorily under the conditions indicated in Tab 1.

**Table 1 : Operating conditions**

Length of ship (m)		< 100	< 200	≤ 300	> 300
<b>Permanent list</b>		15°	15°	15°	15°
Roll		± 22,5°	± 22,5°	± 22,5°	± 22,5°
Pitch		± 10°	± 7,5°	± 5°	± 3°
Trim	Aft	5°	2,5°	1,5°	1°
	Forward	2°	1°	0,5°	0,3°

## 3 Documentation

### 3.1 Refrigerating installations

#### 3.1.1 Plans to be submitted

The plans listed in Tab 2 are to be submitted as applicable.

The listed plans are to be constructional plans complete with all dimensions and are to contain full indication of types of materials employed.

Plans of equipment which are type approved by the Society need not be submitted, provided the types and model numbers are made available.

#### 3.1.2 Calculations to be submitted

The calculations listed in Tab 3 are to be carried out in accordance with criteria agreed with the Society and are to be submitted.

### 3.2 Controlled atmosphere installations

**3.2.1** The plans listed in Tab 4 are to be submitted.

## 4 General technical requirements

### 4.1 Refrigeration of chambers

#### 4.1.1 Refrigerating systems

Refrigeration of the chambers may be achieved by one of the following systems:

- direct cooling system
- indirect cooling system
- air cooling system.

#### 4.1.2 Cold distribution

- The chambers may be refrigerated either by means of grids distributed on their walls or by means of air circulation on air coolers.
- Grids and/or air coolers may be supplied either by brine or by a direct expansion system depending on the type of refrigerating system.

### 4.2 Defrosting

#### 4.2.1 Availability

- Means are to be provided for defrosting air cooler coils, even when the refrigerated chambers are loaded to their maximum. Air coolers are to be fitted with trays and gutters for gathering condensed water.
- The defrosting system is to be designed so that defrosting remains possible even in the case of failure of an essential component such as a compressor, a circulation pump, a brine heater or a heating resistance.

#### 4.2.2 Draining

Arrangements are to be made to drain away the condensate even when the refrigerated chambers are loaded to their maximum. See [5.8] for specific requirements.

**Table 2 : Documents to be submitted**

No.	A/I (1)	Document
1	I	Detailed specification of the plant (refrigerating machinery and insulation) including the reference design and ambient conditions
2	I	General arrangement of refrigerated spaces including: <ul style="list-style-type: none"> <li>• the intended purpose of spaces adjacent to refrigerated spaces</li> <li>• the arrangement of air ducts passing through refrigerated spaces</li> <li>• the arrangement of steelwork located in refrigerated spaces or in insulated walls</li> <li>• the arrangement of the draining system</li> <li>• the individual volume and the total volume of the refrigerated spaces</li> </ul>
3	A	Drawings showing the thickness and methods of fastening of insulation on all surfaces in refrigerated spaces, including: <ul style="list-style-type: none"> <li>• insulation material specification</li> <li>• hatch covers</li> <li>• doors</li> <li>• steel framing (pillars, girders, deck beams)</li> <li>• bulkhead penetrations</li> <li>• etc.</li> </ul>
4	A	Cooling appliances in refrigerated spaces (coil grids, air coolers with air ducts and fans, etc.)
5	I	Characteristic curves of fans (capacity, pressure, power consumption)
6	A	Distribution of the thermometers and description of remote thermometer installation, if any, including: <ul style="list-style-type: none"> <li>• detailed description of the apparatus with indication of the method and instruments adopted, measuring range, degree of accuracy and data regarding the influence of temperature variations on connection cables</li> <li>• electrical diagram of apparatus, with indication of power sources installed, characteristics of connection cables and all data concerning circuit resistance</li> <li>• drawings of sensing elements and their protective coverings and indicators, with specification of type of connections used</li> </ul>
7	A	General arrangement and functional drawings of piping (refrigerant system, brine system if any, sea water system, defrosting system, etc.)
8	I	Characteristic curves of circulating pumps for refrigerant or brine (capacity, pressure, power consumption, etc.)
9	I	General arrangement of refrigerating machinery spaces (main data regarding prime movers for compressors and pumps, including source of power, are to be included in this drawing)
10	A	Electrical wiring diagram
11	A	Compressor main drawings (sections and crankshaft or rotors) with characteristic curves giving the refrigerating capacity
12	A	Drawings of main items of refrigerant system and pressure vessels, such as condensers, receivers, oil separators, evaporators, gas containers, etc.
13	A	Remote control, monitoring and alarm system (if any)
14	A	Air refreshing and heating arrangement for fruit cargo
15	I	Number of insulated cargo containers to be individually cooled by the shipboard plant and their heat transfer rates
16	I	Operation manual for the refrigerating plant and for refrigerated containers, as applicable
(1)	A = for approval; I = for information.	

**Table 3 : Calculations to be submitted**

No	A/I (1)	Item
1	A	Detailed calculation of the heat balance of the plant. The calculation is to take into account the minimum internal temperatures for which the classification is requested and the most unfavourable foreseen ambient conditions.
2	A	Capacity calculations for pressure relief valves and/or bursting disc
3	A	Duct air flow calculations
(1)	A = for approval; I = for information.	

### 4.3 Prime movers and sources of power

#### 4.3.1 Number of power sources

- The motive power for each refrigerating unit is to be provided by at least two distinct sources. Each source is to be capable of ensuring the service of the plant under the conditions stated in [2.1.1], [2.1.2] and [2.1.3], without interfering with other essential services of the ship. For small plants, see also [4.7].
- Where the refrigerating units are driven by internal combustion engines, one power source for each refrigerating unit may be accepted.

#### 4.3.2 Electric motors

Where the prime movers of refrigerating units are electric motors, the electrical power is to be provided by at least two distinct generating sets.

**Table 4 : Documents to be submitted**

No	A/I (1)	Item
1	I	Description of the installation
2	I	Location of spaces covered and gas-tight subdivisions
3	I	Design overpressure
4	A	Details and arrangement of inert gas generating equipment
5	A	Piping diagrams, including installation details
6	A	Ventilation and gas-freeing system
7	A	Instrumentation and automation plans
8	I	Instruction manual
9	I	Cargo space sealing arrangement
(1) A = for approval; I = for information.		

#### 4.3.3 Steam prime movers

Where steam prime movers are used in refrigerating units they are to be connected to at least two different boilers.

Furthermore, the exhaust steam is to be led to the main and auxiliary condensers.

#### 4.4 Pumps

##### 4.4.1 Minimum number of condenser pumps

- At least one standby condenser circulating pump is to be provided; this pump is to be ready for use and its capacity is not to be less than that of the largest pump that it may be necessary to replace.
- One of the condenser circulating pumps may be one of the ship's auxiliary pumps, provided its capacity is sufficient to serve the refrigerating plant working at maximum power without interfering with essential services of the ship.

##### 4.4.2 Plants with intermediate cooling media

- Where an intermediate cooling medium is used, at least one standby brine circulating pump is to be provided; this pump is to be ready for use and its capacity is not to be less than that of the largest pump that it may be necessary to replace.
- The same provision applies to any other type of plants in which the circulation of refrigerant is ensured by pumps.

#### 4.5 Sea connections

##### 4.5.1 Number and location of sea connections

- The cooling water is normally to be taken from the sea by means of at least two separate sea connections.
- The sea connections for the refrigerating plant are to be distributed, as far as practicable, on both sides of the ship.

##### 4.5.2 Connections to other plants

Where the circulating pump(s) of the refrigerating plant is/are connected to the same circuit as other pumps, pre-

cautions are to be taken in the design and arrangement of piping so that the working of one pump does not interfere with another.

##### 4.5.3 Dry dock conditions

In order to keep the refrigerating plant running when the ship is in dry dock, means are to be provided to supply cooling water either from a tank or from a shore connection.

#### 4.6 Refrigerating machinery spaces

##### 4.6.1 Arrangement

Refrigerating machinery spaces are to be provided with efficient means of ventilation and drainage and, unless otherwise allowed by the Society, are to be separated from the refrigerated spaces by means of gas-tight bulkheads.

Ample space is to be provided around the refrigerating machinery to permit easy access for routine maintenance and to facilitate overhauls, particularly in the case of condensers and evaporators.

##### 4.6.2 Dangerous refrigerants in machinery spaces

Use of dangerous refrigerants in machinery spaces may be permitted in accordance with Pt C, Ch 1, Sec 13, [2.2.3].

#### 4.7 Exemptions for small plants

4.7.1 Consideration may be given to waiving the requirements in [4.3.1], [4.3.2] and [4.3.3] above on power source duplication for refrigerating plants serving spaces having a volume below 400 m<sup>3</sup>.

#### 4.8 Personnel safety

4.8.1 Means are to be provided to monitor the presence of personnel in refrigerated cargo spaces and to promptly detect any possible need for help from outside the space.

### 5 Refrigerated chambers

#### 5.1 Construction of refrigerated chambers

##### 5.1.1 Bulkheads surrounding refrigerated chambers

- Generally, the bulkheads of refrigerated chambers are to be of metallic construction; however, the bulkheads between two refrigerated spaces intended to contain cargoes of the same nature or having no contaminating effect need not be metallic.
- The bulkheads are to be gas-tight.
- Steels intended to be used for the construction of refrigerated chambers are to comply with the applicable provisions of Pt B, Ch 4, Sec 1 for low temperature steels.

##### 5.1.2 Closing devices

- The closing devices of the accesses to refrigerated chambers, such as doors, hatch covers and plugs for loading or surveying are to be as far as possible gas-tight.
- The ventilators of refrigerated chambers, if any, are to be fitted with gas-tight closing devices.

## 5.2 Penetrations

### 5.2.1 Penetration of pipes and ducts

Penetrations of pipes through watertight, gas-tight or fire-resistant decks and bulkheads are to be achieved by fitting glands suitable for maintaining the tightness and fire-resisting characteristics of the pierced structures.

### 5.2.2 Penetration of electrical cables

Where electrical wiring passes through refrigerated chambers, the relevant requirements of Part C, Chapter 2 are to be complied with.

## 5.3 Access to refrigerated spaces

### 5.3.1 Doors and hatches

- a) Refrigerated chambers are to be provided with emergency escape ways enabling the evacuation of stretcher-borne personnel. The escape ways are to be provided with emergency lights.
- b) Access doors and hatches to refrigerated chambers are to be provided with means of opening from inside even where they have been shut from outside.

### 5.3.2 Manholes

Manholes on the tank top of refrigerated chambers are to be surrounded by an oil-tight steel coaming of at least 100 mm height.

## 5.4 Insulation of refrigerated chambers

### 5.4.1

- a) The insulating material is to be non-hygroscopic. The insulating boards are to have satisfactory mechanical strength. Insulating materials and binders, if any, are to be odourless and so selected as not to absorb any of the odours of the goods contained in refrigerated chambers. The materials used for linings are to comply with the same provisions.
- b) Polyurethane and other plastic foams used for insulation are to be of a self-extinguishing type according to a standard acceptable by the Society. In general, these foams are not to be used without a suitable protective coating.
- c) The insulation together with its coating is normally to have low flame spread properties according to an accepted standard.
- d) Plastic foams of a self-extinguishing type, suitably lined, may also be used for insulation of piping and air ducts.
- e) When it is proposed to use foam prepared in situ, the detail of the process is to be submitted for examination before the beginning of the work.

## 5.5 Protection of insulation

### 5.5.1 Insulation extension

The insulation and the lining are to be carefully protected from all damage likely to be caused by the goods contained in the chamber or by their handling.

### 5.5.2 Insulation strength

The insulation lining and the air screens with their supports are to be of sufficient strength to withstand the loads due to the goods liable to be carried in the refrigerated chambers.

### 5.5.3 Removable panels

- a) A sufficient number of removable panels are to be provided in the insulation, where necessary, to allow inspection of the bilges, bilge suctions, bases of pillars, vent and sounding pipes of tanks, tops of shaft tunnels and other structures and arrangements covered by the insulation.
- b) Where the insulation is covered with a protective lining, certain panels of this lining are to be provided with a suitable number of inspection openings fitted with watertight means of closing.

## 5.6 Miscellaneous requirements

### 5.6.1 Refrigerated chambers adjacent to oil or fuel tanks

- a) An air space of at least 50 mm is to be provided between the top of fuel and lubricating oil tanks and the insulation, so designed as to allow leaks to drain to the bilges. Such air space may be omitted provided multiple sheaths of an odourless oil-resisting material are applied to the upper surface of tank tops. The total required thickness of sheathing depends on the tank construction, on the composition used and on the method of application.
- b) In general, the sides of fuel and lubricating oil tanks are to be separated from refrigerated spaces by means of cofferdams. The cofferdams are to be vented, the air vents fitted for this purpose are to be led to the open and their outlets are to be fitted with wire gauze which is easily removable for cleaning or renewal. The cofferdams may be omitted provided that multiple sheaths of an odourless oil-resisting material are applied on the tank side surface facing the refrigerated chambers. The total required thickness of this sheathing depends on the composition used and on the method of application.

### 5.6.2 Refrigerated chambers adjacent to high temperature spaces

The insulation of the walls adjacent to coalbunkers or to any space where an excessive temperature may arise, by accident or otherwise, is to be made of mineral wool or any equivalent material; wood chips, if any, are to be fireproof and separated from the plates on which they are fitted by means of insulating sheets.

### 5.6.3 Wooden structures

Wooden beams and stiffeners are to be insulated and strips of suitable insulating material are to be fitted between them and the metallic structures.

### 5.6.4 Metal fittings

All metal fittings (bolts, nuts, hooks, hangers, etc.) necessary for fitting of the insulation are to be galvanised or made in a corrosion-resistant material.

### 5.6.5 Equipment below the insulation

Arrangements are to be made whilst building in order to facilitate the examination in service of parts such as bilge suction, scuppers, air and sounding pipes and electrical wiring which are within or hidden by the insulation.

## 5.7 Installation of the insulation

### 5.7.1

- Before laying the insulation, steel surfaces are to be suitably cleaned and covered with a protective coating of appropriate composition and thickness.
- The thickness of the insulation on all surfaces together with the laying process are to be in accordance with the approved drawings.
- The insulating materials are to be carefully and permanently installed; where they are of slab form, the joints are to be as tight as possible and the unavoidable crevices between slabs are to be filled with insulating material. Bitumen is not to be used for this purpose.
- Joints of multiple layer insulations are to be staggered.
- In applying the insulation to the metallic structures, any paths of heat leakage are to be carefully avoided.

## 5.8 Drainage of refrigerated spaces

### 5.8.1 General

All refrigerated cargo spaces and trays under air coolers are to be fitted with means suitable for their continuous and efficient drainage.

### 5.8.2 Drain pipes

- Drain pipes from refrigerating space cooler trays are to be fitted with liquid sealed traps provided with non-return valves which are easily accessible, even when the chamber is fully loaded.
- Threaded plugs, blank flanges and similar means of closing of drain pipes from refrigerated spaces and trays of air coolers are not permitted.
- Where means of closing of drain pipes are required by the Owner, these are to be easily checked and the controls are to be located in an accessible position on a deck above the full load waterline.

### 5.8.3 Drain tanks

- Where the draining from cargo spaces is led to a closed drain tank, the size of the tank is to be such as to be able to collect all the waters produced during defrosting operations.
- Drain tanks are to be provided with appropriate venting and sounding arrangements.
- When two or more refrigerated spaces are connected to the same drain tank, the common lines are to be fitted with check valves to prevent the possibility of passage of water from one refrigerated space to another.

### 5.8.4 Scuppers

- Scuppers from the lower holds and from trays of air coolers installed on the inner bottom are to be fitted with liquid seals and non-return devices.
- Scuppers from 'tweendeck refrigerated spaces and from trays of air coolers installed above the inner bottom are to be fitted with liquid seals, but not necessarily with non-return devices.
- Where scuppers from more than one refrigerated space or tray are led to a common header or common tank, in addition to the liquid seal on each pipe, a sufficient number of non-return devices are to be provided, so arranged as to prevent lower compartments from being flooded by drains from higher compartments.
- Water seals are to be of sufficient height and readily accessible for maintenance and filling with anti-freezing liquid.
- Valves, scuppers and drain pipes from other non-refrigerated compartments are not to be led to the bilges of refrigerated spaces.

## 6 Refrigerants

### 6.1 General

#### 6.1.1 Refrigerants used in direct refrigerating systems

Some commonly employed refrigerants considered acceptable for use with primary (direct expansion) systems are listed in Tab 5.

#### 6.1.2 Refrigerants used in indirect refrigerating systems

Ammonia (R717) may be used only in indirect system refrigerating plants.

**Table 5 : Refrigerants for use in direct refrigerating systems**

Refrigerant Number	Refrigerant commercial name	Chemical Formula
R12	Dichlorodifluoromethane	C Cl <sub>2</sub> F <sub>2</sub>
R21	Dichlorofluoromethane	CH Cl <sub>2</sub> F
R22	Chlorodifluoromethane	CH Cl F <sub>2</sub>
R113	Trichlorotrifluoroethane	C Cl <sub>2</sub> F C Cl F <sub>2</sub>
R114	Dichlorotetrafluoroethane	C Cl F <sub>2</sub> C Cl F <sub>2</sub>
R134a	Tetrafluoroethane	CH <sub>2</sub> F C F <sub>3</sub>
R500	Refrigerant 12/152a 73.8/26.2 wt%	C Cl <sub>2</sub> F <sub>2</sub> / CH <sub>3</sub> CH F <sub>2</sub>
R502	Refrigerant 12/115 48.8/51.2 wt%	CH Cl F <sub>2</sub> / C Cl F <sub>2</sub> C F <sub>3</sub>



### 6.1.3 Other permissible refrigerants

The use of refrigerants other than those listed in Tab 5 may be authorised by the Society on a case-by-case basis, provided that the physical properties and chemical analysis are clearly stated and the appropriate safety measures are foreseen in the installation design.

### 6.1.4 Prohibited refrigerants

For restrictions on the selection of refrigerants, see Pt C, Ch 1, Sec 13, [2.2.1] and Pt C, Ch 1, Sec 13, [2.2.2].

### 6.1.5 Use of ammonia as refrigerant

For specific requirements relative to the use of ammonia as refrigerant, see Pt C, Ch 1, Sec 13, [2.3].

## 6.2 Rated working pressures

### 6.2.1 Pressure parts design pressure

- The refrigerant design pressure is not to be less than the maximum working pressure of the installation or its parts, either in operation or at rest, whichever is the greater. No safety valve is to be set at a pressure higher than the maximum working pressure.
- In general, the design pressure of the low pressure side of the system is to be at least the saturated vapour pressure of the refrigerants at 40°C. Due regard is to be paid to the defrosting arrangement which may increase the pressure on the low pressure system.
- The design pressure of the high pressure side of the installation is to be based on the condenser working pressure while it operates with water cooling in tropical zones. In general, the rated working pressure is to be taken not less than the effective saturated vapour pressure at 50°C.

### 6.2.2 Refrigerants listed in Table 5

In general, the design pressure for high and low pressure parts of systems using refrigerants listed in Tab 5 is to be taken not less than the values indicated in Tab 6.

## 7 Refrigerating machinery and equipment

### 7.1 General requirements for prime movers

#### 7.1.1

- The diesel engines driving the compressors are to satisfy the relevant requirements of Pt C, Ch 1, Sec 2.
- The electric motors driving the compressors, pumps or fans are to satisfy the relevant requirements of Pt C, Ch 1, Sec 4.

### 7.2 Common requirements for compressors

#### 7.2.1 Casings

The casings of rotary compressors are to be designed for the design pressure of the high pressure side of the system indicated in Tab 6.

Table 6 : Design working pressure

Refrigerant number	High pressure side	Low pressure side
R12	1,6 MPa	1,0 MPa
R21	0,3 MPa	0,2 MPa
R22	2,2 MPa	1,3 MPa
R113	0,2 MPa	0,2 MPa
R114	0,4 MPa	0,4 MPa
R134a	1,3 MPa	1,1 MPa
R500	2,0 MPa	1,2 MPa
R502	2,3 MPa	1,6 MPa
R717	2,2 MPa	1,5 MPa
R744	1,1 MPa	0,7 MPa

### 7.2.2 Cooling

- Air-cooled compressors are to be designed for an air temperature of 45°C.
- For sea water cooling, a minimum inlet temperature of 32°C is to be applied. Unless provided with a free outlet, the cooling water spaces are to be protected against excessive overpressure by safety valves or rupture safety devices.

### 7.2.3 Safety devices

- Stop valves are to be provided on the compressor suction and discharge sides.
- A safety valve or rupture disc is to be arranged between the compressor and the delivery stop valve.
- When the power exceeds 10 kW, the protection may consist of a pressure control device which automatically stops the machine in the event of overpressure. Details of the design of this device are to be submitted to the Society.
- Compressors arranged in parallel are to be provided with check valves in the discharge line of each compressor.
- Means are to be provided to indicate the correct direction of rotation.

### 7.3 Reciprocating compressors

#### 7.3.1 Crankcase

- When subjected to refrigerant pressure, compressor crankcases are to be either:
  - designed to withstand the rated working pressure of the LP side; or
  - fitted with safety valves designed to lift at a pressure not exceeding 0,8 times the crankcase test pressure; in this case, arrangements are to be made for the refrigerant to discharge to a safe place; or
  - protected against overpressures by means of devices likely to ensure a similar protection.
- An oil level sight glass is to be fitted in the crankcase.
- Means are to be provided to heat the crankcase when the compressor is stopped.

### 7.3.2 Hydraulic lock

Reciprocating compressors having cylinder bores of 50 mm and above are to be provided with means to relieve high pressure due to hydraulic lock. Alternatively means to prevent the possibility of refrigerants entering the cylinders may be considered.

## 7.4 Screw compressor bearings

**7.4.1** Whenever the bearing surfaces are locally hardened, details of the process are to be submitted to the Society. In any case, the process is to be limited to the bearing area and is not to be extended to the fillets.

## 7.5 Pressure vessels

### 7.5.1 General

The general requirements of Pt C, Ch 1, Sec 13, [2.1.2] are applicable.

### 7.5.2 Refrigerant receivers

- The receivers are to have sufficient capacity to accumulate liquid refrigerant during changes in working conditions, maintenance and repairing.
- Each receiver is to be fitted with suitable level indicators. Glass gauges, if any, are to be of the flat plate type and are to be heat resistant. All level indicators are to be provided with shut-off devices.
- Each receiver that may be isolated from the system is to be provided with an adequate overpressure safety device.

### 7.5.3 Evaporators and condensers

- All parts of evaporators and condensers are to be accessible for routine maintenance; where deemed necessary, efficient means of corrosion control are to be provided.
- When condensers and evaporators of the "coil-in-casing" type cannot be readily dismantled owing to their dimensions, a suitable number of inspection openings not smaller than 230x150 mm<sup>2</sup> are to be provided on their shells.
- Safety valves are to be fitted on the shells of evaporators and condensers when the pressure from any connected pump may exceed their anticipated working pressure.

### 7.5.4 Brine tanks

- Brine tanks which can be shut off are to be protected against excessive pressure due to thermal expansion of the brine by safety valves or by an interlocking device blocking the shut-off valves in open position.
- In general, brine tanks are not to be galvanised at their side in contact with brine. Where they are galvanised and are of a closed type, they are to be provided with a suitable vent arrangement led to the open for toxic gases. The vents are to be fitted with easily removable wire gauze diaphragms and their outlets are to be located in positions where no hazard for the personnel may arise from the gases. Where brine tanks are not of a closed type, the compartments in which they are located are to be provided with efficient ventilation arrangements.

### 7.5.5 Air coolers

- Where finned-tube or multi-plate type air coolers are used, the distance between the fins or plates is not to be less than 10 mm, at least on the air inlet side. For the purpose of this requirement, the air inlet side means 1/4 of the length of the cooler measured in the direction of the air flow.
- Air coolers are to be made of corrosion-resistant material or protected against corrosion by galvanising.
- Air coolers are to be provided with drip trays and adequate drains.

### 7.5.6 Insulation

Pressure vessels are to be thermally insulated to minimise the condensation of moisture from the ambient atmosphere. The insulation is to be provided with an efficient vapour barrier and is to be protected from mechanical damage.

## 7.6 General requirements for piping

### 7.6.1 General

The general requirements of Pt C, Ch 1, Sec 13, [2.1.3] are applicable.

### 7.6.2 Piping arrangement

- Pipelines are to be adequately supported and secured so as to prevent vibrations. Approved type flexible hoses may be used where necessary to prevent vibrations.
- Provision is to be made for allowing thermal expansion and contraction of the piping system under all operating conditions. Approved type flexible hoses may be used where necessary for this purpose.
- Pipe insulation is to be protected from mechanical damage and is to be provided with an efficient vapour barrier which is not to be interrupted in way of supports, valves, fittings, etc.

## 7.7 Accessories

### 7.7.1 Oil separators

Oil separators with drains are to be fitted on the refrigerant lines. When a wire gauze is fitted, this is to be of material which cannot be corroded by the refrigerant.

### 7.7.2 Filters

- Efficient filters are to be fitted at the suction of compressors and on the high pressure side of reducing valves. The filters of compressors may be incorporated in the crankcases, provided their filtering area is sufficient.
- Filters are to be fitted with a wire gauze strainer which cannot be corroded by the refrigerant and allowing a sufficient flow area for the fluid. Small filters such as those of reducing valves are to be such that they can be easily removed without any disassembling of the pipes.

### 7.7.3 Dehydrators

An efficient dehydrator is to be fitted on systems using refrigerant types R12, R21, R22 or R502. The dehydrator is to be so designed and arranged that the drying product can be replaced without any disassembling of the pipes.

## 7.8 Refrigerating plant overpressure protection

### 7.8.1 General

- a) The refrigerant circuits and associated pressure vessels are to be protected against overpressure by safety valves, rupture discs or equivalent arrangement. However, inadvertent discharge of refrigerant to the atmosphere is to be prevented.
- b) The safety devices are to be in such number and so located that there is no possibility that any part of the system may be isolated from a safety device. Where it is necessary to be able to isolate one of these devices from the system for maintenance purposes, the valves may be duplicated provided a change-over valve is arranged in such a way that when one device is isolated it is not possible to shut off the other.
- c) Pressure vessels connected by pieces of pipe without valves may be considered as a single pressure vessel from the point of view of overpressure protection, provided that the interconnecting pipe does not prevent effective venting of the vessels.

### 7.8.2 Safety valves

- a) Safety valve discharges are to be led to a safe place above the deck. Discharge pipes are to be designed in such a way that the ingress of water, snow, dirt or debris affecting the operation of the system can be prevented. In the case of the refrigerant R717 (ammonia), the discharge pipe outlet is to be as high as possible on the ship.
- b) Refrigerant pumps are to be fitted with safety valves at the discharge side. The valves may discharge at the pump suction side or at another suitable location.
- c) After setting, safety valves are to be suitably protected against the possibility of inadvertent change of setting.
- d) Safety valves are to lift at a pressure not more than 0,80 times the test pressure of the parts concerned.

## 8 Specific requirements for direct and indirect refrigerating systems

### 8.1 Specific requirements for refrigerating systems

#### 8.1.1 Direct expansion system

- a) Refrigerating systems where the refrigerant expands directly in the coils within the refrigerated chambers may be considered by the Society only for application in chambers of small capacity and at the specific request of the Owner.
- b) For the acceptance of such a system by the Society, special consideration is to be given to the following:
  - the proposed refrigerant
  - the use of coil pipes having butts welded circumferentially within refrigerated chambers, to prevent leakages of gas within the chambers themselves

- the effective protection of chamber cooling coils within the chambers from shocks and external mechanical damage.
- c) Coils within each refrigerated space are to be arranged in at least two sections, and the number of sections in each refrigerated space is to be clearly indicated on the plan to be submitted for approval. Each section is to be fitted with valves or cocks so that it can be shut off.

#### 8.1.2 Brine systems

- a) Each brine pump is to be connected to the brine tanks and to the valve manifolds controlling the brine pipes. Each brine pipe is to be fitted with a stop valve on the delivery, and a regulating valve is to be fitted on the return pipe.
- b) All regulating valves are to be located in positions accessible at any time.
- c) Brine pipes are not to be galvanised on the inside.
- d) The thickness of the brine pipes is to be not less than 2,5 mm; in the case of pipes with threaded joints, the thickness at the bottom of the thread is not to be less than the above value.
- e) Steel pipe cooling coils and their associated fittings are to be externally protected against corrosion by galvanising or other equivalent method.
- f) For brine tanks, see [7.5.4].

## 8.2 Specific requirements for air cooling systems and distribution and renewal of air in cargo spaces

### 8.2.1 Rated circulation

The air circulation system is to be so designed as to ensure as uniform as possible a distribution of air in refrigerated spaces.

### 8.2.2 Refrigerated air circulation systems

- a) For air coolers, see [7.5.5].
- b) Air coolers are to be designed for a maximum temperature difference between cooling medium and cooling air at the air cooler inlet of about 5°C for fruit cargoes and about 10°C for deep frozen cargoes.
- c) Air coolers may be operated either by brine circulation or by direct expansion of the refrigerant.
- d) The coils are to be divided into two sections, each capable of being easily shut off (see Ch 7, Sec 2, [1.2.1]).
- e) Means for defrosting the coils of the air coolers are to be provided. Defrosting by means of spraying with water is to be avoided.
- f) Provision is to be made for heating the drains. In automated plants, the heating equipment is to be controlled by the defrosting program.
- g) Fans and their motors are to be arranged so as to allow easy access for inspection and repair and/or removal of the fans and motors themselves when the chambers are loaded with refrigerated cargo. Where duplicate fans and motors are fitted and each fan is capable of supplying the quantity of air required, it is sufficient that easy access for inspection is provided.

- h) The air circulation is to be such that delivery and suction of air from all parts of the refrigerated chambers are ensured.
- i) The air capacity and the power of the fans are to be in proportion to the total heat to be extracted from the refrigerated chambers, due regard being given to the nature of the service.
- j) When excess cooling capacity is required in order to cool or freeze all or part of the cargo from the ambient temperature to the minimum anticipated temperature, the air capacity is to be in proportion to the increased heat to be extracted, in accordance with the specifications approved by the Owner.

**8.2.3 Air refreshing**

- a) When refrigerated cargoes include goods which, under certain conditions, emit gases, odours or humidity, an efficient system is to be provided for air refreshing in the space concerned. Air inlets and outlets in such systems are to be provided with closing devices.
- b) The position of air inlets is to be such as to reduce to a minimum the possibility of contaminated air entering the refrigerated spaces.

**9 Instrumentation, alarm, monitoring**

**9.1 General**

**9.1.1 Automation safety equipment**

The automation safety equipment is to be of the fail-safe type and is to be so designed and installed as to permit manual operation. In particular, manual operation of the compressors is to be ensured in the event that any of the equipment is inoperable.

**9.1.2 Regulation devices**

Regulation devices such as motor-operated valves or thermostatic expansion valves are to be such that they can be isolated, thus allowing the plant to be manually operated should the need arise.

**9.2 Instrumentation, alarm and monitoring arrangement**

**9.2.1 Compressors**

Tab 7 summarises the minimum control and monitoring requirements for refrigerating compressors.

**9.2.2 Refrigerating systems**

Tab 8 summarises the minimum control and monitoring requirements for refrigerating systems.

**Table 7 : Refrigerating compressors**

Item	Indicator	Function			Comments
			Alarm	Automatic shutdown	
Refrigerant suction	pressure	low		X	At saturated temperature and including intermediate stages
Refrigerant discharge	pressure	high		X	
Refrigerant suction	temperature				For installations over 25 kW only
Refrigerant discharge	temperature				
Lubricating oil	pressure	low		X	
Lubricating oil	temperature				For installations over 25 kW only
Cooling water	temperature				For installations over 25 kW only
Cumulative running hours	hours				All screw compressors and installations over 25 kW only

**Note 1:** Shut-off is also to activate an audible and visual alarm.

**Table 8 : Refrigerating systems**

Item	Indicator	Function			Comments
			Alarm	Automatic shutdown	
Air in refrigerated space	temperature	high	X		
Air fan		failure	X		
Chamber temperature	temperature		X		
Secondary refrigerant suction	pressure	low		X	
Secondary refrigerant discharge	pressure	high		X	
Lubricating oil	pressure	low		X	
Bilge level in refrigerated space		high	X		

**Note 1:** Shut-off is also to activate an audible and visual alarm.

## 10 Material tests, inspection and testing, certification

### 10.1 Material testing

**10.1.1** The materials for the construction of the parts listed below are to be tested in compliance with the requirements of NR216 Materials and Welding:

- compressor crankshafts, couplings, connecting rods and piston rods
- compressor liners, cylinder heads and other parts subjected to pressure
- steel and copper tubing for evaporator and condenser coils and for pressure piping in general
- oil separators, intermediate receivers and other pressure vessels included in the gas circuit
- condensers and evaporators of shell type (tube or welded plate).

### 10.2 Shop tests

#### 10.2.1 Individual pieces of equipment

Shop tests are to be carried out on pumps, fans, electric motors and internal combustion engines forming parts of refrigerating installations, following procedures in accordance with the requirements applicable to each type of machinery. The relevant running data (capacity, pressure head, power and rotational speed, etc.) are to be recorded for each item.

#### 10.2.2 Refrigerating unit

- a) At least one refrigerating unit of each type installed on board is to be subjected to shop tests in order to ascertain its refrigerating capacity in the most unfavourable temperature conditions expected, or in other temperature conditions established by the Society.
- b) Where the complete unit cannot be shop tested (for instance, in the case of direct expansion installations), only the compressors are to be tested according to procedures approved by the Society.

### 10.3 Pressure tests at the workshop

#### 10.3.1 Strength and leak tests

Upon completion, all parts included in the suction and delivery branches of the refrigerant circuit are to be subjected to a strength and leak test.

The strength test is a hydraulic test carried out with water or other suitable liquid. The leak test is a test carried out with air or other suitable gas while the component is submerged in water at a temperature of approximately 30°C.

The components to be tested and the test pressure are indicated in Tab 9.

#### 10.3.2 Condensers

Circulating water sides of condensers are to be subjected to a hydrostatic test at a pressure equal to 1,5 times the design pressure, but in no case less than 0,1 N/mm<sup>2</sup>.

Table 9 :

Component	Test pressure	
	Strength test	Leak test
Compressor cylinder blocks, cylinder covers, stop valves, pipes and other components (condensers, receivers, etc.) of the high pressure part of the circuit.	1,5 p <sub>1</sub>	p <sub>1</sub>
Compressor crankcases subjected to refrigerant pressure, stop valves, pipes and other components of the low pressure part of the circuit.	1,5 p <sub>2</sub>	p <sub>2</sub>
Where p <sub>1</sub> and p <sub>2</sub> are the design pressures indicated in [6.2] for high pressure and low pressure parts.		

#### 10.3.3 Brine system

- a) Brine coils of air coolers are to be subjected to a hydrostatic test at a pressure equal to 1,5 times the design pressure, but in no case less than 0,7 N/mm<sup>2</sup>.
- b) Cast iron casings for brine evaporators are to be subjected to a hydrostatic test at a pressure equal to 1,5 times the design pressure, but in no case less than 0,1 N/mm<sup>2</sup>.
- c) Steel casings for brine evaporators fitted on the suction side of the pumps are to be subjected to a hydrostatic test at a pressure not less than 0,2 N/mm<sup>2</sup>.
- d) Steel casings for brine evaporators fitted on the delivery side of the pumps are to be subjected to a hydrostatic test at a pressure equal to 1,5 times the design pressure, but in no case less than 0,35 N/mm<sup>2</sup>.
- e) Open brine tanks are to be tested by filling them completely with water.

### 10.4 Thermometers and manometers

#### 10.4.1

- a) All thermometers recording the temperature of refrigerated spaces, the air temperature at the inlet and outlet of air coolers and the temperature at various points in the refrigerant circuit or in the brine circuit are to be carefully calibrated by the Manufacturer. The Society reserves the right to require random checks of the calibration.
- b) The accuracy of manometers and other measuring instruments is also to be checked before the commencement of the tests required in [10.5].

### 10.5 Shipboard tests

#### 10.5.1 Pressure tests

After installation on board, and before operating, the plant is to be subjected to a test at the maximum working pressure determined as indicated in [6.2.1].

However, all pressure piping portions which have welded joints made on board are to be subjected to a strength test at a pressure equal to 1,5 times the rated working pressure before being insulated.

### 10.5.2 Tests of the ventilation system

- a) After installation, the ventilation system is to be tested and the pressure, air capacity in cubic metres per minute, maximum rotational speed and power absorbed by the fans are to be recorded.
- b) The distribution of air in the various refrigerated spaces is to be checked.

### 10.5.3 Operational tests

- a) Upon completion of the installation, each refrigerating plant is to be subjected to an operational test on board in order to check the proper operation of the machinery and the refrigerating capacity of the plant by means of a heat balance test.
- b) Before starting the actual test, the Surveyor will check at random that thermometers, pressure gauges and other instruments are in working order, calibrated and arranged as directed in each case by the Society.
- c) All the refrigerating machinery is to be put into service and all chambers, closed and empty, are to be simultaneously cooled to the minimum expected temperature, i.e. the temperature required to be entered in the notation, or a lower temperature determined so that a difference of at least 20°C can be maintained between the average external temperature and the temperature in the refrigerated spaces. The expected temperature is to be maintained for a period of time sufficient to remove all the heat from the insulation.
- d) Following this, the heat balance test may be commenced. The duration of the test may be 6 hours or, where necessary, even longer. Air cooler fans are to run at their normal output throughout the test.
- e) The regulation of the refrigerating capacity of the plant may be effected by reducing the number of running compressors, by varying their rotational speed or even by running them intermittently.
- f) Means of control where the load in the cylinders is varied or the gas is returned from the delivery side to the suction side are not permitted.
- g) The following data are to be recorded in the course of the test:
  - Temperatures in the refrigerated spaces, external air temperature and sea water temperature (in particular, at the outlet and inlet of the condensers). The external surfaces  $S$  of the walls corresponding to the temperature differences  $DT$  measured between the inside and outside of the refrigerated spaces are to be detailed as well as the products  $S^2DT$ .

- Absorbed power and speed of the compressors and the temperatures and pressures which determine the running of the refrigerating machinery. The recorded data, through comparison with the thermodynamic cycle considered for the preparation of the cold production curves of the compressors, are to enable the corrections (superheating, undercooling) necessary for determination of the actual refrigerating capacity  $F$ .

- Absorbed power of the motors driving the fans  $F_V$  and brine pumps  $F_P$
- The overall heat transfer coefficient  $k$  for the extreme climatic conditions considered may be obtained by the following formula:

$$F = k \Sigma(S \cdot \Delta T) + F_V + F_P + F_C$$

where  $F_C$  is a correcting term (normally small) which is to be introduced for other heat exchanges between the tested plant and the environment. The calculation of the coefficient  $k$  is required when the total volume of the holds exceeds 400 m<sup>3</sup>.

- h) Temperatures and pressures at various locations along the refrigerant and brine circuits.
  - i) Air temperatures at the inlet and outlet of air coolers.
  - j) In the course of the heat balance test, the above data is to be recorded at one-hour intervals. Prior to this test, the data may be recorded at 4-hour intervals, except for the external air and sea water temperatures, which are to be recorded at one-hour intervals at least for the last twelve hours of the test.
- k) Special cases, e.g. when the test is carried out with very low external atmospheric temperatures which would require the temperature within the refrigerated cargo spaces to be brought down below the above specified values, or where the compressors are driven by constant speed prime movers, or where refrigerating plants of banana and fruit carriers are tested in winter time, or the minimum temperature required for classification is not the same for all the spaces will be specially considered by the Society.

## 10.6 Defrosting system

- 10.6.1** The defrosting arrangements are also to be subjected to an operational test.

Instructions regarding the procedure to be followed for the operational test of the refrigerating plant on board will be given by the Society in each case.

## SECTION 2

## ADDITIONAL REQUIREMENTS FOR NOTATION REF-CARGO

### 1 General

#### 1.1 Application

**1.1.1** The requirements of this Section are applicable for the assignment of the additional class notation **REF-CARGO**. They are additional to the applicable requirements of Ch 7, Sec 1.

**1.1.2** These requirements are applicable independently of the number of refrigerated holds. Where only certain holds are fitted with a refrigerating plant for which the notation is requested, the number and the location of these holds will be indicated in an annex to the Certificate of Classification.

#### 1.2 Refrigeration of cargo spaces

**1.2.1** Cooling appliances, including brine coils, if any, are to be divided into two distinct systems capable of working separately in each refrigerated space; each of them is to be able to keep the cargo in a satisfactory cold condition. Each section is to be fitted with valves or cocks or similar devices so that it can be shut off.

**1.2.2** Consideration may be given to waiving the requirements in [1.2.1] on cooling system duplication for refrigerating plants serving spaces having volume below 200 m<sup>3</sup>.

#### 1.3 Heating

**1.3.1** Where it is intended to carry cargoes which may be adversely affected by low temperatures during cold seasons or in certain geographical areas, efficient means are to be provided for heating the spaces concerned.

### 2 Refrigerated cargo spaces

#### 2.1 Insulation

##### 2.1.1 Protection of insulation

In addition to the requirement in Ch 7, Sec 1, [5.5.1], the floors of refrigerated spaces to about 600 mm beyond the projection of the hatchway outline are to be covered with a hard wood sheathing about 50 mm thick, or with a protection of similar efficiency.

##### 2.1.2 Insulation strength

In addition to the requirement in Ch 7, Sec 1, [5.5.2], where insulations are to support fork-lift trucks, they are to be submitted to a strength test performed on a sample in conditions representative of the service conditions.

##### 2.1.3 Cargo battens

- a) Cargo battens of 50x50 mm, spaced at approximately 400 mm, are to be fitted to the vertical boundaries of refrigerated cargo spaces.
- b) Floors of refrigerated cargo spaces are to be similarly fitted with battens of 75x75 mm spaced at approximately 400 mm; over the insulation of the top of shaft tunnels, cargo battens are to be of hard wood.
- c) The arrangement of the cargo battens is to be such that free circulation of air is not impaired and cargo cannot come in contact with the insulation or with the brine coils, if any.
- d) Battens on the floors of refrigerated spaces may be omitted in the case of hanging cargoes.

### 3 Instrumentation

#### 3.1 Thermometers in cargo spaces

##### 3.1.1 Number of thermometers

Each refrigerated space with a volume not exceeding 400 m<sup>3</sup> is to be fitted with at least 2 thermometers or temperature sensors. Where the volume exceeds 400 m<sup>3</sup>, this number is to be increased by one for each additional 400 m<sup>3</sup>.

##### 3.1.2 Direct reading thermometers

The tubes intended to contain thermometers are to have a diameter not less than 50 mm and are to be carefully isolated from the ship's structure. If they pass through spaces other than those they serve, they are to be insulated when passing through those spaces. Joints and covers of such tubes are to be insulated from the plating to which they are attached and installed on open decks so that water will not collect and freeze in them when measuring temperatures.

##### 3.1.3 Electric thermometer apparatus for remote reading

The apparatus is to provide the temperature indications with the accuracy required in [3.1.5] in conditions of vibrations and inclinations expected on board and for all ambient temperatures, up to 50°C, to which indicating instruments and connection cables may be exposed.

##### 3.1.4 Distant electric thermometer sensors

- a) Sensing elements are to be placed in refrigerated spaces where they are not liable to be exposed to damage during loading and unloading operations and well clear of heat sources such as, for instance, electric lamps, etc.

- b) Sensing elements in air coolers are to be placed at a distance of at least 900 mm from coils or fan motors.
- c) When arranged in ducts, they are to be placed at the centre of the air duct section, as far as possible.
- d) Sensing elements are to be protected by a corrosion-resistant impervious covering. Conductors are to be permanently secured to sensing elements and to indicating instruments and connected accessories. Plug-and-socket connections are allowed only if they are of a type deemed suitable by the Society.
- e) All sensing elements are to be easily accessible.

### 3.1.5 Accuracy

- a) Direct reading thermometers are to permit reading with an accuracy of 0,1°C for temperatures between 0°C and 15°C. Temperatures given by remote reading are to have an accuracy of:
  - $\pm 0,3^\circ\text{C}$  (at 0°C) for the carriage of fruit and vegetables, and
  - $\pm 0,5^\circ\text{C}$  (at 0°C) for the carriage of frozen products.
- b) The instrumental error, to be ascertained by means of calibration by comparison with a master-thermometer with officially certified calibration, is not to exceed the following values:
  - $\pm 0,15^\circ\text{C}$ , in the range - 3°C to + 3°C
  - $\pm 0,25^\circ\text{C}$ , in all other ranges of the scale.
- c) In general, the scale range is to be within -30°C and +20°C; in any case it is to be  $\pm 5^\circ\text{C}$  greater than the range of application of the instrument.
- d) In the graduated scale, the space between each degree centigrade is not to be less than 5 mm.

### 3.1.6 Data-logger

- a) When a data-logger is installed, at least one sensing element for each refrigerated space, both in the space itself and in its air circulating system, is to be connected to another independent indicating instrument, approved by the Society. The data-logger is to register to 0,1 of a degree. Indicating instruments are to be fed by two independent power sources. If they are fed by the network on board through a transformer and rectifier unit, a spare unit is also to be provided and is to be easily replaceable aboard. If they are fed by storage batteries, it will be sufficient to arrange easily changeable batteries.
- b) A prototype apparatus is to be checked and tested by a Surveyors at an independent recognised laboratory, or at the Manufacturer's facilities, to verify by means of suitable tests that the degree of accuracy corresponds to the above provisions.
- c) The capacity of the apparatus to withstand stipulated vibrations, impacts and temperature variations and its non-liability to alterations due to the salt mist atmosphere, typical of conditions on board, are to be verified.

## 4 Additional requirements for AIR-CONT notation

### 4.1 General

#### 4.1.1 Applicability

- a) The following requirements apply to ships with permanently installed equipment capable of generating and controlling an oxygen poor atmosphere in cargo holds in order to slow down the ripening process of fruit or other cargo, for which the notation **AIRCONT** is requested.
- b) The following requirements are additional to those of Ch 7, Sec 1.
- c) The **AIRCONT** notation will be not granted to ships using portable apparatus for the generation of the controlled atmosphere or to ships with permanently installed apparatus serving less than 50% of the allowable cargo space.

#### 4.1.2 Operational performance

- a) Normally, the displacement of the oxygen from the spaces which are intended to operate under controlled atmosphere is obtained by an inert gas. The most commonly used inert gases are:
  - carbon dioxide (CO<sub>2</sub>)
  - nitrogen (N<sub>2</sub>)
- b) The oxygen content in air controlled spaces is to be maintained between 10% and 2% of the volume, with an accuracy of at least 0,2%.
- c) Where carbon dioxide is used for controlling the atmosphere, the plant is to be capable of controlling and maintaining a concentration of CO<sub>2</sub> in all or in any of the controlled spaces between 10% and 0,2% in volume. The selected CO<sub>2</sub> content is to be maintained with an accuracy of at least 0,2%.
- d) Where nitrogen (N<sub>2</sub>) is used to control the atmosphere, the generating plant is to be capable of supplying at least:
  - 0,05 m<sup>3</sup>/h of nitrogen with 4% oxygen content for each cubic meter of the total cargo space which is intended for controlled atmosphere, at normal operating temperature
  - 0,025 m<sup>3</sup>/h of nitrogen with 2% oxygen content for each cubic meter of the total cargo space which is intended for controlled atmosphere, at normal operating temperature
  - For different oxygen content, intermediate values may be interpolated.

#### 4.1.3 Operating and safety manual

An operating and safety manual covering at least the items listed below is to be provided on board:

- principal information on the use of controlled atmosphere



- complete description of the controlled atmosphere installation on board
- hazards of low oxygen atmospheres and consequential effects on human life
- countermeasures when exposed to low oxygen atmospheres
- instructions for operation, maintenance and calibration of all gas detectors
- instructions for use of portable oxygen analysers with alarm for personal protection
- prohibition of entry to spaces under controlled atmospheres
- loading instructions prior to injection of gas
- procedure for checking security of controlled atmosphere zones, doors and access hatches prior to injection of gas
- gas-freeing procedure for all controlled atmosphere zones
- procedure for checking atmosphere of controlled atmosphere zones before entry.

## 4.2 Controlled atmosphere cargo spaces and adjacent spaces

### 4.2.1 Air-tightness of controlled atmosphere

- a) The controlled atmosphere zones are to be made air-tight. Particular attention is to be paid to sealing of hatches, plugs and access doors in each controlled atmosphere zone. Double seals are to be fitted to each opening.
- b) Openings for pipes, ducts, cables, sensors, sampling lines and other fittings passing through the decks and bulkheads are to be suitably sealed and made air-tight.
- c) The liquid sealed traps from bilges and drains from the cooler trays are to be deep enough, when filled with liquid which will not evaporate or freeze, to withstand the design pressure in each controlled atmosphere zone taking account of the ship motion.
- d) Air refreshing inlets and outlets are to be provided with isolating arrangements.

### 4.2.2 Controlled atmosphere zone protection

- a) Means are to be provided to protect controlled atmosphere zones against the effect of overpressure or vacuum.
- b) One pressure/vacuum valve is to be fitted in each controlled atmosphere zone, set for the design conditions of the zone.
- c) The proposed pressure/vacuum valves for the various zones are to be of adequate size to release any excess pressure when the gas generating unit is delivering at its maximum capacity to a single cargo space or compartment and to relieve the vacuum at maximum cooling rate.

- d) Pressure/vacuum valve discharges are to be located at least 2 m above the open deck and 10 m away from any ventilation inlets and openings to accommodation spaces, service spaces, machinery spaces and other similar manned spaces. Discharge piping is to be arranged to preclude ingress of water, dirt or debris which may cause the equipment to malfunction.
- e) Arrangements for the protection of cargo spaces or compartments against over or under pressure other than those referred to above will be the subject of special consideration.

### 4.2.3 Gas freeing

- a) The arrangements for gas freeing of controlled atmosphere zones are to be capable of purging all parts of the zone to ensure a safe atmosphere.
- b) Cargo air cooling fans and the air refreshing arrangements may be used for gas freeing operations.
- c) Gas freeing outlets are to be led to a safe place in the atmosphere 2 m above the open deck and 10 m away from air inlets and openings to accommodation spaces, service spaces, machinery spaces and similar manned spaces.

### 4.2.4 Ventilation of adjacent zones

- a) Deckhouses and other adjacent spaces, or other spaces containing gas piping where gas leakage may create an oxygen deficient atmosphere, which need to be entered regularly, are to be fitted with a positive pressure type mechanical ventilation system with a capacity of at least 10 air changes per hour capable of being controlled from outside these spaces.
- b) Adjacent spaces not normally entered are to be provided with a mechanical ventilation system which can be permanent or portable to free the gas space prior to entry. Where portable ventilators are used, at least two units capable of ensuring at least 2 air changes per hour in the largest of such spaces are to be kept on board.
- c) Ventilation inlets are to be arranged so as to avoid recycling any gas.
- d) For container carriers with containers under controlled atmosphere which have arrangements to vent low oxygen air from each container under controlled atmosphere into the cargo space, venting arrangements are to be in accordance with the applicable requirements of these Rules.

## 4.3 Gas systems

### 4.3.1 General requirements

- a) Means are to be provided to reach and maintain the required oxygen and/or carbon dioxide levels in the controlled atmosphere zones. This may be accomplished by use of stored gas, portable or fixed gas generating equipment or other equivalent arrangements.
- b) The gas system is to have sufficient capacity to compensate for any gas loss from the controlled atmosphere zones and to maintain a positive pressure in all such zones.

- c) Gas systems utilising compressors are to be provided with two or more compressors and prime movers which together are capable of delivering the rated capacity. Each compressor is to be sized so that, with one compressor out of operation, the system is able to maintain the O<sub>2</sub> content in all designated cargo spaces within the specified range. Alternatively, one compressor and prime mover may be accepted if the compressor is capable of delivering the rated capacity and provided that spares for the compressor and prime mover are carried to enable any failure of the compressor and prime mover to be rectified on board.
- d) Air inlets are to be located such as to ensure that contaminated air is not drawn into the compressors.
- e) Where it is intended to supply gas by means of stored gas bottles, the arrangements are to be such that depleted bottles may be readily and safely disconnected and charged bottles readily connected.

#### 4.3.2 Carbon dioxide generation

Carbon dioxide generating equipment is the subject of special consideration by the Society.

#### 4.3.3 Passive type nitrogen generation

Passive type nitrogen generators such as gas separators and absorption units need not be duplicated.

#### 4.3.4 Gas supply

- a) Gas systems are to be designed so that the pressure which they can exert on any controlled atmosphere zone will not exceed the design pressure of the zone.
- b) During initial operation, arrangements are to be made to vent the gas outlets from each generator to the atmosphere. All vents from gas generators are to be led to a safe location on the open deck.
- c) Where gas generators use positive displacement compressors, a pressure relief device is to be provided to prevent excess pressure being developed on the discharge side of the compressor.
- d) Suitable arrangements are to be provided to enable the supply mains to be connected to an external supply
- e) Where nitrogen (N<sub>2</sub>) is used:
  - means of controlling inadvertent release of nitrogen into controlled atmosphere zones, such as lockable non-return valves, are to be provided.
  - the nitrogen delivery line is to be fitted with a safety valve capable of discharging the maximum nitrogen delivery.
  - filters are to be fitted in the delivery line.
  - oxygen and nitrogen exhaust lines are to be led to discharge in safe locations on open deck.

#### 4.3.5 Segregation

- a) Fixed gas generating equipment, gas bottles or portable gas generators are to be located in a compartment reserved solely for their use. Such compartments are to be separated by a gas-tight bulkhead and/or deck from

accommodation, machinery, service and control spaces. Access to such compartments is only to be from the open deck.

- b) Gas piping systems are not to be led through accommodation, service and machinery spaces or control stations.

#### 4.3.6 Protection of cargo spaces

- a) Means to protect the cargo spaces from overpressure are to be provided. These means may be:
  - in the case of external gas supply, a shut-off valve automatically operated in the event of overpressure fitted at the connection with the external supply
  - a vent valve, connected to the inlet valve, ensuring that the inlet of nitrogen is allowed when the vent valve is open.
- b) Nitrogen outlets to the atmosphere are to be directed vertically upward and are to be located in segregated positions which are not likely to discharge into manned areas.

#### 4.3.7 Ventilation

- a) The gas supply compartment is to be fitted with an independent mechanical extraction ventilation system providing a rate of at least 20 air changes per hour based on the total empty volume of the compartment.
- b) Ventilation ducts from the gas generator/supply compartment are not to be led through accommodation, service and machinery spaces or control stations.
- c) The air exhaust ducts are to be led to a safe location on the open deck.

### 4.4 Miscellaneous equipment

#### 4.4.1 Humidification equipment

Where a humidification system is fitted, the following requirements are to be complied with:

- a) the supply of fresh water for humidification is to be such as to minimise the risk of corrosion and contamination of the cargo
- b) in order to prevent damage or blockage in the humidification system caused by water freezing, the air, steam or water pipelines in the cargo chambers are to be installed so as to facilitate drainage and to be provided with suitable heating arrangements.

#### 4.4.2 Electrical equipment

In addition to the applicable requirements of Part C, Chapter 2 of the Rules, the following are to be complied with:

- a) the electrical power for the controlled atmosphere plant is to be provided from a separate feeder circuit from the main switchboard
- b) under seagoing conditions, the number and rating of service generators are to be sufficient to supply the cargo refrigeration machinery and controlled atmosphere equipment in addition to the ship's essential services, when any one generating set is out of action.

## 4.5 Gas detection and monitoring equipment

### 4.5.1 General

- The indicators and alarms required in this Section are all to be given at a suitable refrigerated cargo control station.
- The pressure in each controlled atmosphere zone is to be monitored and an alarm initiated when the pressure is too high or too low.
- Direct read-out of the gas quality within any controlled atmosphere zone is to be available to the operating staff on demand.

### 4.5.2 Oxygen and carbon dioxide detection

- All cargo spaces intended for controlled atmosphere are to be fitted with means for measuring the oxygen and carbon dioxide content.

The values are to be automatically logged at regular intervals (generally every hour) for the entire period in which the cargo space is kept under controlled atmosphere.

- Gas analysers are to be calibrated automatically once every 24 hours. An alarm is to be initiated if accuracy is outside tolerance limits.
- Each normally manned space adjacent to cargo spaces, intended to be operated under controlled atmosphere, is to be fitted with at least one means to measure the oxygen content.
- When humidification equipment is installed in each of the controlled atmosphere zones, an alarm is to be initiated when the relative humidity falls below or exceeds the predetermined set values.

### 4.5.3 Sampling and analysing system

- At least two analysers for oxygen and carbon dioxide having a tolerance of  $\pm 0,1$  per cent by volume are to be

provided to determine the content of the circulated gas within the controlled atmosphere zones.

- When a sampling system with sequential analysing is fitted, the sampling lines are to be able to operate at any value of pressure or vacuum at which the controlled air system may operate in the cargo space. Common sampling lines for different media (oxygen, carbon dioxide, etc.) are allowed.
- Two separate sampling points are to be located in each controlled atmosphere zone and one sampling point in each of the adjacent spaces. The arrangements are to be such as to prevent water condensing and freezing in the sampling lines under normal operating conditions. Filters are to be provided at the inlet to sampling point lines.
- Arrangements of the gas sampling points are to be such as to facilitate representative sampling of the gas in the space.
- Where gas is extracted from the controlled atmosphere zones via a sampling tube to analysers outside the space, the sample gas is to be discharged safely to the open deck.
- Sampling by means of portable equipment will be the subject of special consideration.
- The sampling frequency is to be at least once per hour.

### 4.5.4 Alarm for gas release

An audible and visual alarm is to be automatically operated for at least 60 seconds before the gas release in the cargo spaces is initiated. The alarm is to be interlocked with the gas inlet valve, in such a way that the valve cannot be opened until the alarm has been given.

## 4.6 Instrumentation, alarm and monitoring arrangement

4.6.1 Tab 1 summarises the minimum control and monitoring requirements for controlled atmosphere plants.

Table 1 :

Item	Indicator	Function			Comments
			Alarm	Automatic shut-down	
Oxygen content	percentage	low	X		Cargo spaces
		high	X		
		< 21%	X		Manned spaces adjacent to cargo spaces
Carbon dioxide content	percentage		X		Cargo spaces
Atmospheric pressure	pressure	high	X	X (1)	
Gas generation		failure	X		Failure of any one of the generating equipment
Gas release		release	X		To be operated for at least 60 seconds before release
Liquid seal level		low	X		Where installed
Ventilation		failure	X		
Sampling line flow		failure	X		
Logging		failure	X		

(1) Automatic closing of inlet valve of externally supplied gas.

## 4.7 Safety

### 4.7.1 Access to controlled atmosphere zones

- a) Controlled atmosphere zones are to be clearly labelled with "Caution" and "Danger" signs to alert personnel.
- b) Entry hatch and manhole covers and doors leading to controlled atmosphere zones and adjacent spaces are to be fitted with acceptable security type locks and warning notices informing about the low oxygen atmosphere. Warning notices are to be posted at all openings to spaces under controlled atmosphere to prevent inadvertent opening while the space is under the controlled atmosphere.
- c) All doors and access hatches to controlled atmosphere zones which may be under pressure are to open outwards and are to be fitted with means to prevent injury or damage during opening.

### 4.7.2 Safety equipment

- a) At least 10 portable oxygen monitors with alarms are to be provided on board.
- b) At least two portable oxygen sensors are to be provided to sample the oxygen level in all controlled atmosphere zones and adjacent spaces for use prior to entry into such zones or spaces.
- c) A means of two-way communication is to be provided between the cargo spaces under controlled atmosphere and the gas release control station. If portable radiotelephone apparatus is adopted to comply with this requirement, at least three sets are to be provided on board. This equipment is to be in addition to that required by SOLAS Chapter III, Regulation 6.
- d) Two self-contained breathing apparatuses equipped with built-in radio communication and a lifeline with a belt are to be provided on board together with fully charged spare air bottles with a total free air capacity of 3600 litres for each breathing apparatus. This equipment is to be in addition to that required by SOLAS Chapter II-2, Regulation 17.

## 4.8 Tests and trials

### 4.8.1 General

Controlled atmosphere system trials are to be carried out on board before the system is put into service, as indicated below.

### 4.8.2 Tightness tests

- a) Piping
  - 1) The gas supply mains and branches are to be pressure and leak tested. The test pressures are to be 1,5 and 1,0 times the design pressure, respectively.
  - 2) All gas sampling lines are to be leak tested using a vacuum or overpressure method.

### b) Air-tightness in controlled atmosphere

- 1) Air-tightness of each controlled atmosphere zone is to be tested and the results entered on the certificate. The measured leakage rate of each zone is to be compared with the specified value.
- 2) Either a constant pressure method or a pressure decay method is to be used to determine the degree of air-tightness.
- 3) If the constant pressure method is used, the test is to be carried out at the design pressure of the controlled atmosphere zones.
- 4) If the pressure decay method is used, the time for the pressure to drop from 350 Pa to 150 Pa is to be measured and the leakage is to be calculated using the following formula:

$$Q = 7,095 \cdot \frac{V}{t}$$

where:

Q : Air leakage, in m<sup>3</sup>/h

V : Volume of zone, in m<sup>3</sup>

t : Time, in seconds

7,095 : Constant for 200 Pa pressure decay.

- 5) During this test, the adjacent zones are to be kept at atmospheric pressure.

### 4.8.3 Gas system performance

The capability of the gas system to supply gas according to the specified flow rate and conditions is to be verified by tests.

### 4.8.4 Gas freeing

The gas freeing arrangements are to be tested to demonstrate that they are effective.

### 4.8.5 Safety, alarms and instrumentation

- a) The control, alarm and safety systems are to be tested to demonstrate overall satisfactory performance of the control engineering installation. Testing is also to take account of the electrical power supply arrangements.
- b) Locking arrangements of all controlled atmosphere zones and adjacent spaces where gas may accumulate, provision of warning notices at all entrances to such spaces, communication arrangements and operation of alarms, controls, etc. are to be examined.
- c) The provision of portable gas detectors and personnel oxygen monitors is to be verified. Suitable calibrated instruments to measure the levels of O<sub>2</sub>, CO<sub>2</sub> and humidity, gas pressure and gas flow to the controlled atmosphere zones are to be provided for testing. Their accuracy is to be verified.

## 5 Additional requirements for notations PRECOOLING and QUICKFREEZE

### 5.1 General

#### 5.1.1 Applicability

The following requirements apply to ships for which either the **PRECOOLING** or **QUICKFREEZE** notation is requested. The requirements of this Section are additional to those in Ch 7, Sec 1.

#### 5.1.2 Conditions of assignment

The notations **PRECOOLING** and **QUICKFREEZE** are assigned in connection with the maximum time necessary to cool the cells from the ambient temperature to the service temperature with the cargo loaded at the ambient temperature. This time is to be indicated in the contract specification together with the specified temperatures and, upon verification, to be entered in the notation.

#### 5.1.3 Additional requirements for PRECOOLING notation

- a) Unless otherwise specified for special cargoes, the rate of cold air circulation within each space is not normally to be less than 70 changes per hour. Lower values may

be accepted locally for zones with lesser ventilation. However, for any zone, in any right parallelepiped having 1 m<sup>2</sup> of ceiling surface as a base and the height of the space, the rate of circulation is not to be less than 40 changes per hour; moreover, the average rate of circulation is not to be less than 60 changes per hour in any parallelepiped with the same height and based on 50 m<sup>2</sup> of ceiling surface.

- b) For a system with horizontal air circulation, the average and local rates of circulation are not to be less than those mentioned above for vertical circulation.
- c) Unless duly justified, the local and average rates of circulation of refrigerated air are to be checked for the empty spaces.

### 5.2 Shipboard tests

#### 5.2.1 Additional requirement for PRECOOLING notation

For the notation **PRECOOLING**, during the ventilation system tests the conditions stated in [5.1.3] are to be verified. The detailed procedure of the test is to be previously submitted to the Society.

## SECTION 3

# ADDITIONAL REQUIREMENTS FOR NOTATION REF-CONT

### 1 General

#### 1.1 Application

**1.1.1** The requirements of this Section are applicable for the assignment of the additional class notation **REF-CONT**. They are additional to the applicable requirements of Ch 7, Sec 1.

**1.1.2** Where the containers are cooled by a permanently installed refrigerating plant designed to supply refrigerated air to insulated containers carried in holds of container ships, the suffix **(A)** will be added to the notation **REF-CONT**.

Where the ship is intended only to supply electrical power to self-refrigerated containers, the suffix **(E)** will be added to the notation **REF-CONT**.

**1.1.3** Where air conditioning or insulation of the holds is necessary for the carriage of refrigerated containers, the corresponding items are also to be considered for granting the appropriate class notation.

#### 1.1.4 Containers

Refrigerated containers are not covered by the class notation and accordingly no specific requirements for the containers are contained in these Rules.

However, the heat transfer coefficient of the containers is to comply with the value appearing in the notation; see also Ch 7, Sec 1, [1.2.2].

## 2 Refrigerating plants supplying refrigerated air to containers

### 2.1 Definitions

#### 2.1.1 Batch of containers

A batch of containers or simply a batch is a set of containers served by the same duct and the same air cooler.

#### 2.1.2 Decentralised refrigerating plant

A decentralised refrigerating plant is a plant in which each container is connected on board to a separate unit for cold production and distribution.

### 2.2 Cold distribution

#### 2.2.1 Systems serving batches of containers

The system of cold distribution of each air cooler serving a batch of containers is to be divided into two distinct parts capable of working separately, each of them being able to ensure the requested cold supply. This requirement need

not be complied with where the air cooler serves no more than 7 standard 40 ft containers (or 14 standard 20 ft containers).

#### 2.2.2 Decentralised refrigerating plants

Fully decentralised fixed refrigerating plants are normally to comply with the same provisions as foreseen for centralised plants. However, while a standby refrigerating unit is not required in this case, at least two compressors, each one able to supply two thirds of the necessary refrigerating capacity (or an equivalent arrangement), are to be provided.

#### 2.2.3 Regulation valves

The regulation valves for supply of brine to air coolers are to be so arranged that they can be isolated, unless it is possible to operate them manually in the case of damage to their automatic control device. However, the manual operation of these valves is not required where it is possible to arrange for their quick replacement while the containers are on board. In such case, the proposed list of spare valves is to be submitted to the Society.

#### 2.2.4 Air cooler fans

Where a single fan is provided for each air cooler, the arrangement is to be such that it is possible to proceed with the disassembling of the fan and/or the associated motor of each air cooler while the containers are on board. In this case, at least one spare fan and one motor of each type are to be available on board.

### 2.3 Equipment and systems

#### 2.3.1 Couplings

The couplings for connection to containers are to be of an approved type.

#### 2.3.2 Compressors

In addition to the compressors which are necessary for the compressed air production system used for the operation of couplings, at least one standby air compressor or equivalent is to be provided. This compressor is to be arranged to be immediately available and its capacity is to be at least equal to that of the largest compressor it is to replace.

#### 2.3.3 Air ducts

- a) Ducts for discharge and suction of refrigerated air are to be suitably insulated; they are to be air-tight in order to avoid an abnormal increase in the cold demand and an abnormal decrease in the temperature of air in the holds.
- b) The insulating materials and linings used for the ducts are to comply with the provisions of Ch 7, Sec 1, [7.4].

### 2.3.4 Other ducts and piping

- a) Ducts for entry of fresh air and exhaust of stale air which serve a batch of containers are to be arranged so that they can be segregated from the ducts serving other batches in order to avoid contamination by odour of the remains of the cargo in case of damage.
- b) Similar provision is to be made in respect of the piping for drainage of defrosting water and condensation products from air coolers. Each drainage pipe is to be fitted with a hydraulic scupper or equivalent.
- c) Ducts for exhaust of stale air are to be led to the open. However, where the holds are sufficiently ventilated (rate of air renewal per hour not normally less than 4), these ducts may be led to the holds.

### 2.3.5 Containers with controlled atmosphere

For containers with controlled atmosphere, see Ch 7, Sec 2, [4.2.4] d).

## 2.4 Thermometers

### 2.4.1 Temperature sensors

- a) At least two temperature sensors are to be provided for each container. One is to be arranged at the air suction, the other at the air supply. The latter may, however, be common to several containers if the arrangements are such that the same air temperature is ensured at all the air supply outlets. In this case, the sensor is to be located at the air cooler exhaust in the air stream common to all these outlets.
- b) The sensors and thermometers are to be of an approved type.

### 2.4.2 Temperature recording

- a) The system for recording the temperature measurements is to be completely duplicated. Where this is not feasible, it is to be possible, in case of failure of the main system or of a main cable, to intervene with the necessary instrument in way of each hold in order to record the temperatures of supply and suction air for each container. In this case, arrangements are to be such that the staff in charge of these measurements can operate from an easily accessible location.
- b) For fully decentralised plants, the duplication is not required provided that a temperature regulator-indicator is provided for the air supply to each container. These devices are to be located together in one or several easily accessible positions.
- c) For plants with more than 200 containers, the temperature monitoring system is to be automated and is to include alarms for low and high temperatures. Proposed arrangements are to be submitted to the Society.
- d) At least 2% of the number of temperature sensors of each type (with a minimum of 5 per type) are to be provided as spares.

## 2.5 Workshop and shipboard inspections and tests

### 2.5.1 Circulating pumps

The characteristics (capacity, pressure and absorbed power) of circulating pumps for cooling media (sea water, brine, refrigerant) are to be checked at the works where the prime movers have an output exceeding 50 kW. The test is to be performed for each type of pump and attended by a Surveyor; at least 3 points suitably distributed over each curve are to be considered.

### 2.5.2 Motors of air cooler fans

Where the Manufacturer cannot indicate the efficiency for each type of motor and for a resisting torque varying from 20% to 100% of the rated couple of this motor, the corresponding measurement may be required during inspection at the works of the motors.

### 2.5.3 Compressors

- a) A check of the refrigerating power of each type of compressor is to be performed for various running conditions. The latter are to correspond, at least, to those foreseen in the heat balance for the extreme operating conditions.
- b) Tests are normally to be performed at the works of the makers. When tests are carried out on board, the proposed procedure is to be approved by the Society.
- c) For identical plants made by the same maker and intended for ships of the same series, tests are only required for the first ship provided that their results are satisfactory.
- d) Direct checking of the refrigerating power is not required where it is intended to perform a test, with all the containers on board, at the lowest temperature and in the extreme operating conditions specified.

### 2.5.4 Air coolers

Where considered necessary taking into account the characteristics of the plant, the Society may require that the distribution of the brine flow to the various air coolers is checked on board.

### 2.5.5 Air ducts

- a) Air-tightness of ducts together with their connections and couplings is to be achieved to the Surveyor's satisfaction. Each duct is to be tested for air-tightness.
- b) Air-tightness of each duct is to be checked after closing of all pipes such as drains and stale air exhausts which are not a source of leakage in normal operation. Two tests are to be performed, the first with all the couplings sealed by tight plugs, the second without such plugs.
- c) The leakage rate  $Q_0$  is to be measured with an overpressure not appreciably less than 25 mm of water; for a different overpressure  $\Delta P$  (mm water), the measured leakage rate  $Q$  is to be corrected to obtain  $Q_0$  by the formula:

$$Q_0 = Q \left( \frac{25}{\Delta P} \right)^{1/2}$$

The leakage rate  $Q_0$  is not to exceed by more than 5% the values given in Tab 1 multiplied by the number of containers served by the tested duct.

- d) One duct of each type is to be submitted to a test for air distribution to containers. This test includes measurement of the air flow at the various couplings; during the test, the fans run at full speed and at the rated pressure. The air flow at each coupling is not normally to be lower than the specified value, with a minus tolerance of 5%.
- e) The overall heat exchange coefficient is to be determined for at least two different types of ducts; the result is not to exceed by more than 10% the value considered in the heat balance. For large series (at least 50), 2% of the ducts are to be subjected to this test.
- f) In the case of ducts fabricated on board, tests for air-tightness, air distribution, and heat leakage as defined above are to be performed on board after assembly. In this case, after special examination and where there is a large excess of refrigerating capacity, the Society may agree to waive the test mentioned in e).
- g) Testing procedure is to be submitted for approval.

**Table 1 :**

Type of container	40'	30'	20'	10'
$Q_0$ in m <sup>3</sup> /h (at 15°C, 760 mm Hg)	30 (60)	23 (46)	16 (32)	9 (18)
<b>Note 1:</b> The lower value corresponds to the first test, the larger one to the second test performed without the plugs.				

## 2.6 Temperature measuring and recording devices

### 2.6.1 Temperature sensors

- a) For plants comprising more than 200 temperature sensors for air supply and suction, including those used for regulation of the supply air temperature, the following checks are to be performed:
  - checking of the tightness of the sealings after immersion during 30 minutes under 1 m of water or after an equivalent test
  - checking of the calibration for at least 3 temperatures suitably distributed over the measuring range; to be done immediately after completion of the previous test.
- b) These checks are to be carried out from 2 batches of sensors chosen at different periods (the middle and end of fabrication). At least 1% (with a minimum of 10) of the number of sensors are chosen by the Surveyor to be checked.

### 2.6.2 Temperature monitoring system

A test of the complete temperature monitoring system is to be performed at the Manufacturer's workshop (for each ship, even in the case of identical plants installed in sister

ships) and is to be attended by the Surveyor. However, for small plants equivalent tests may be performed on board.

## 2.7 Shipboard tests

### 2.7.1 Temperature sensors

- a) The correct operation of all temperature sensors for the whole plant is to be checked on board. Installation of sensors, together with their connecting cables, is to be checked for accuracy.
- b) The zero of the sensors located on the air supplies and suctions in the ducts is to be randomly checked. The checking is to be effected by comparison with pure water ice (0°C). At least one sensor for supply and one sensor at the air flow suction side are to be checked.
- c) It is also to be checked that the regulation sensor for supply air gives the same value as the reading sensor, and that there are no abnormal differences for the reading sensors that have not been checked in accordance with this requirement.

### 2.7.2 Ducts

- a) Before checking the correct operation of the ducts and their fittings, it is to be verified that their air-tightness has not been impaired during their handling or their installation on board. The Surveyor may require that tests (smoke tests or equivalent) are performed at random.
- b) The two leakage tests defined in [2.5.5] are to be performed for ducts which have been dismantled in more than two parts for transportation or which have been assembled on board from prefabricated parts. In this case, and except for one duct of each type, these tests need not be carried out at the works. Where, however, they have been already performed at the works, one is to be repeated on board.
- c) The Surveyor may require that the air-tightness is checked at the junction between the couplings and the containers installed on board for the test. This may be done with soapy water or by a similar procedure.
- d) Where fitted in the ducts at the works, electric motors of duct fans are subjected to insulation measurements; this is to be done at random and as agreed with the Surveyor.

### 2.7.3 Running tests

- a) The running of the major components of the fluid systems (refrigerant, cold and hot brine, sea water, air for couplings) and of the regulation, monitoring and alarm systems is to be checked.
- b) The correct running of the plant in automatic operation is to be checked for the specified conditions. Tests are to be performed for the various operating conditions and for at least three ducts of different types which are to be fully fitted up with containers. The satisfactory operation of the whole plant is also to be verified by means of a suitable test.
- c) When there is a plant for air conditioning of the holds, it is to be tested in accordance with Ch 7, Sec 2.



### **3 Ships supplying electrical power to self-refrigerated containers**

#### **3.1 Electrical equipment**

**3.1.1** In addition to the applicable requirements of Part C, Chapter 2 of the Rules, the following are to be complied with:

- a) the electrical power for the controlled atmosphere plant is to be provided from a separate feeder circuit from the main switchboard

- b) under seagoing conditions, the number and rating of service generators are to be sufficient to supply the cargo refrigeration machinery and controlled atmosphere equipment in addition to the ship's essential services, when any one generating set is out of action.

#### **3.2 Installation of containers**

**3.2.1** The loading of refrigerated containers is to be restricted to locations where proper ventilation and cooling of the refrigerating equipment may be ensured.

## SECTION 4

## ADDITIONAL REQUIREMENTS FOR NOTATION REF-STORE

### 1 General

#### 1.1 Application

**1.1.1** For the assignment of the additional class notation **REF-STORE**, and in addition to the applicable requirements of Ch 7, Sec 1, the additional requirements of Ch 7, Sec 2 are to be complied with, with the exception of those of Ch 7, Sec 2, [1.3] and Ch 7, Sec 2, [2.1].

Part F  
**Additional Class Notations**

Chapter 8  
**ICE CLASS (ICE)**

---

- SECTION 1      GENERAL**
- SECTION 2      HULL AND STABILITY**
- SECTION 3      MACHINERY**



# SECTION 1

# GENERAL

## 1 General

### 1.1 Application

**1.1.1** The following additional class notations are assigned in accordance with Pt A, Ch 1, Sec 2, [6.10] to ships strengthened for navigation in ice and complying with the relevant requirements of this Chapter:

- ICE CLASS IA SUPER
- ICE CLASS IA
- ICE CLASS IB
- ICE CLASS IC
- ICE CLASS ID
- YOUNG ICE 1
- YOUNG ICE 2

**1.1.2** The ice strengthening requirements in this Chapter, excepting those for ships with the additional class notation **ICE CLASS ID**, **YOUNG ICE 1** or **YOUNG ICE 2**, are equivalent to those stated in the Finnish-Swedish Ice Class Rules 2010, as amended, applicable to ships trading in the Baltic Sea in winter or equivalent ice conditions.

**1.1.3** As a guidance, Tab 1 provides relation between the additional class notations **YOUNG ICE 1** and **YOUNG ICE 2** and the associated ice conditions compatible with the strengthening requirements in Ch 8, Sec 2, [7].

**Table 1 : Ice conditions  
for YOUNG ICE 1 and YOUNG ICE 2**

Notation	Ice forming stage	Ice concentration
<b>YOUNG ICE 1</b>	Young ice (gray or whitish) having a maximum thickness of 30 cm	Open ice (concentration between 6 and 3/10th)
<b>YOUNG ICE 2</b>		Very open ice (concentration less than 3/10th)

### 1.2 Owner's responsibility

**1.2.1** It is the responsibility of the Owner to decide which ice class notation is the most suitable in relation to the expected service conditions of the ship.

Nevertheless, it is to be noted that a ship assigned with **ICE CLASS IA SUPER** is not to be considered as a ship suitable for navigation in ice in any environmental condition, such as an icebreaker.

### 1.3 Documents to be submitted

**1.3.1** The plans relevant to shell expansion and fore and aft part structures are to define (see [2.2]) the maximum draught LWL, the minimum draught BWL (both draughts at midship, fore and aft ends), and the borderlines of fore, midship and aft regions defined in Ch 8, Sec 2, [1.2].

## 2 Ice class draughts and ice thickness

### 2.1 Definitions

#### 2.1.1 Upper ice waterline

The Upper Ice Waterline (UIWL) is the envelop of highest points of the waterlines at which the ship is intended to operate in ice. The line may be a broken line.

#### 2.1.2 Lower ice waterline

The Lower Ice Waterline (LIWL) is the envelop of lowest points of the waterlines at which the ship is intended to operate in ice. The line may be a broken line.

#### 2.1.3 Ice belt

The ice belt is that portion of the side shell which is to be strengthened. Its vertical extension is defined in Ch 8, Sec 2, Tab 1.

### 2.2 Draught limitations in ice

#### 2.2.1 Maximum draught

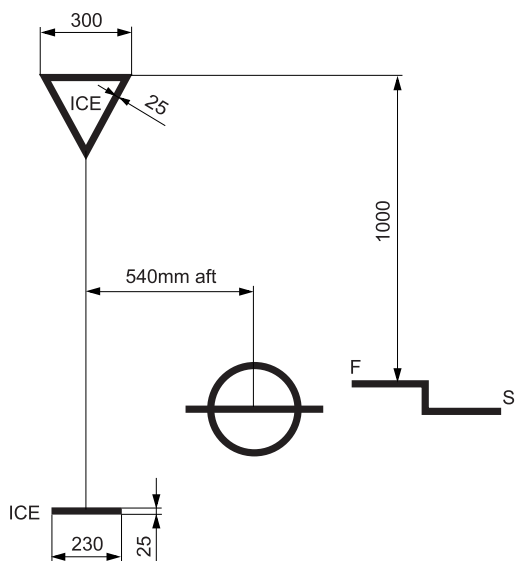
The draught and trim limited by the UIWL are not to be exceeded when the ship is navigating in ice.

The salinity of the sea water along the intended route is to be taken into account when loading the ship.

#### 2.2.2 Minimum draught

The ship is always to be loaded down at least to the draught of LIWL amidships when navigating in ice. Any ballast tank situated above the LIWL and needed to load down the ship to this waterline is to be equipped with devices to prevent the water from freezing.

**Figure 1 : Ice class draught marking**



Note 1: The upper edge of the warning triangle is to be located vertically above the "ICE" mark, 1000 mm higher than the summer load line in fresh water but in no case higher than the deck line. The sides of the triangle are to be 300 mm in length.

Note 2: The ice class draught mark is to be located 540 mm abaft the centre of the load line ring or 540 mm abaft the vertical line of the timber load line mark, if applicable.

Note 3: The marks and figures are to be cut out of 5 - 8 mm plate and then welded to the ship's side. The marks and figures are to be painted in a red or yellow reflecting colour in order to make the marks and figures plainly visible even in ice conditions.

Note 4: The dimensions of all figures are to be the same as those used in the load line mark.

Note 5: The upper horizontal line above the triangle represents the ship deck line.

The lower horizontal line below the triangle represents the UIWL.

### 2.2.3 Minimum forward draught

In determining the LIWL, due regard is to be paid to the need to ensure a reasonable degree of ice going capability in ballast. The highest point of the propeller is to be submerged and if possible at a depth of at least  $h_i$  below the water surface in all loading conditions. The minimum forward draught is to be at least equal to the value  $T_{AV}$ , in m, given by the following formula:

$$T_{AV} = (2 + 0,00025\Delta_1)h_i$$

where:

$\Delta_1$  : Displacement of the ship, in t, determined from the waterline on the UIWL, as defined in [2.2.1]. Where multiple waterlines are used for determining the UIWL, the displacement must be determined from the waterline corresponding to the greatest displacement.

$h_i$  : Ice thickness, in m, as defined in [2.3].

The draught  $T_{AV}$  need not, however, exceed  $4 h_i$ .

### 2.2.4 Indication of maximum and minimum draughts in ice

Restrictions on draughts when operating in ice are to be documented and kept on board readily available to the master.

The maximum and minimum ice class draughts fore, amidships and aft are to be specified in the documents submitted for approval to the Society and stated on the Certificate of Classification.

If the summer load line in fresh water is anywhere located at a higher level than the UIWL, the ship's sides are to be provided with a warning triangle and with a draught mark at the maximum permissible ice class draught amidships, according to Fig 1.

The purpose of the warning triangle is to provide information on the draught limitation of the ship when it is sailing in ice for masters of icebreakers and for inspection personnel in ports.

## 2.3 Ice thickness

### 2.3.1 Height of the ice load area

- An ice strengthened ship is assumed to operate in open sea conditions corresponding to an ice level with a thickness not exceeding the value  $h_i$ .
- The design ice load height  $h$  of the area under ice pressure at any time is assumed to be only a fraction of the ice thickness.
- The values for  $h_i$  and  $h$ , in m, are given in Tab 2.

**Table 2 : Ice load height**

Notation	$h_i$ (m)	$h$ (m)
<b>ICE CLASS IA SUPER</b>	1,0	0,35
<b>ICE CLASS IA</b>	0,8	0,30
<b>ICE CLASS IB</b>	0,6	0,25
<b>ICE CLASS IC</b> <b>ICE CLASS ID</b>	0,4	0,22
<b>YOUNG ICE 1</b> <b>YOUNG ICE 2</b>	0,3	0,19

## 3 Output of propulsion machinery

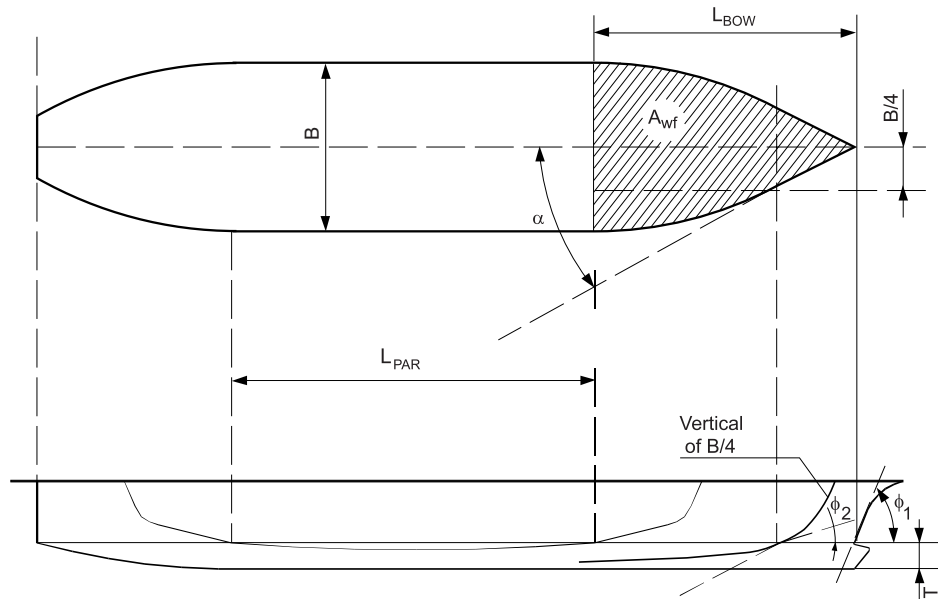
### 3.1 Required engine output for ICE CLASS IA SUPER, ICE CLASS IA, ICE CLASS IB and ICE CLASS IC

**3.1.1** The engine output,  $P$ , is the total maximum output the propulsion machinery can continuously deliver to the propeller(s). If the output of the machinery is restricted by technical means or by any regulations applicable to the ship,  $P$  is to be taken as the restricted output. If additional power sources are available for propulsion power (e.g. shaft motors), in addition to the power of the main engine(s), they are also to be included in the total engine output.

The engine output is to be not less than that determined according to [3.1.3] and in no case less than 1000 kW for ice class **ICE CLASS IA**, **ICE CLASS IB** and **ICE CLASS IC**, and not less than 2800kW for **ICE CLASS IA SUPER**.

No minimum engine output is required for notations **ICE CLASS ID**, **YOUNG ICE 1** and **YOUNG ICE 2**.

Figure 2 : Determination of the geometric quantities of the hull



### 3.1.2 Definitions

The dimensions of the ship, defined below, are measured on the maximum ice class draught of the ship as defined in [2.2.1]. For the symbol definitions, see also Fig 2.

- L : Length of the ship between the perpendiculars, in m
- $L_{BOW}$  : Length of the bow, in m
- $L_{PAR}$  : Length of the parallel midship body, in m
- B : Maximum breadth of the ship, in m
- T : Actual ice class draught of the ship, in m, according to [3.1.3]
- $A_{wf}$  : Area of the waterline of the bow, in  $m^2$
- $\alpha$  : Angle of the waterline at B/4, in deg
- $\phi_1$  : Rake of the stem at the centreline, in deg, taken equal to 90 if the ship has a bulbous bow
- $\phi_2$  : Rake of the bow at B/4, in deg
- $\psi$  : Flare angle, in deg, taken equal to  $\arctan(\tan \phi_2 / \sin \alpha)$
- $D_p$  : Diameter of the propeller, in m
- $H_M$  : Thickness of the brash ice in mid-channel, in m
- $H_F$  : Thickness of the brash ice layer displaced by the bow, in m.

### 3.1.3 Minimum required power

The engine output requirement P is to be calculated for two draughts. Draughts to be used are the maximum draught amidship referred to as UIWL and the minimum draught amidship referred to as LIWL, as defined in [2.2]. In the calculation the ship's parameters which depend on the draught are to be determined at the appropriate draught, but L and B are to be determined only at the UIWL. The engine output is to be not less than the greater of these two outputs. These two outputs, in kW, are to be determined by the following formula:

$$P = K_C \frac{\left(\frac{R_{CH}}{1000}\right)^{3/2}}{D_p}$$

where:

$K_C$  : Defined in Tab 3

**Table 3 : Values of  $K_C$  for conventional propulsion systems**

Number of propellers	Controllable pitch propellers or electric or hydraulic propulsion machinery	Fixed pitch propellers
1 propeller	2,03	2,26
2 propellers	1,44	1,60
3 propellers	1,18	1,31

**Note 1:** These  $K_C$  values apply for conventional propulsion systems. Other methods may be used for determining the required power for advanced propulsion systems (see [3.1.4]).

$R_{CH}$  : Ice resistance of the ship in a channel with brash ice and a consolidated layer, in N, taken equal to:

$$R_{CH} = C_1 + C_2 + C_3(H_F + H_M)^2(B + C_\psi H_F)C_\mu + C_4 L_{PAR} H_F^2 + C_5 \left(\frac{LT}{B^2}\right)^3 \frac{A_{wf}}{L}$$

with

$$20 \geq \left(\frac{LT}{B^2}\right)^3 \geq 5$$

$C_1$  : Coefficient taking into account a consolidated upper layer of the brash ice and to be taken:

- for **ICE CLASS IA SUPER**:

$$C_1 = \frac{f_1 B L_{PAR}}{2T} + (1 + 0,021 \phi_1)(f_2 B + f_3 L_{BOW} + f_4 B L_{BOW})$$

- for **ICE CLASS IA, ICE CLASS IB and ICE CLASS IC**:

$$C_1 = 0$$

$C_2$  : Coefficient taking into account a consolidated upper layer of the brash ice and to be taken:

- for **ICE CLASS IA SUPER**:

$$C_2 = (1 + 0,063 \phi_1)(g_1 + g_2 B) + g_3 \left(1 + 1,2 \frac{T}{B}\right) \frac{B^2}{L^{0,5}}$$

- for **ICE CLASS IA**, **ICE CLASS IB** and **ICE CLASS IC**:

$$C_2 = 0$$

$C_\psi$  : Coefficient equal to:

- if  $\psi \leq 45^\circ$ ,  $C_\psi = 0$
- otherwise,  $C_\psi = 0,047 \psi - 2,115$

$C_\mu$  : Coefficient equal to:

$$C_\mu = 0,15 \cos \phi_2 + \sin \psi \sin \alpha$$

without being less than 0,45

$H_F$  :  $0,26 + (H_M B)^{0,5}$

$H_M$  : Coefficient defined in Tab 4

$$C_3 = 845 \text{ kg/m}^2\text{s}^2$$

$$C_4 = 42 \text{ kg/m}^2\text{s}^2$$

$$C_5 = 825 \text{ kg/s}^2$$

$$f_1 = 23 \text{ N/m}^2$$

$$f_2 = 45,8 \text{ N/m}$$

$$f_3 = 14,7 \text{ N/m}$$

$$f_4 = 29 \text{ N/m}^2$$

$$g_1 = 1530 \text{ N}$$

$$g_2 = 170 \text{ N/m}$$

$$g_3 = 400 \text{ N/m}^{1,5}$$

### 3.1.4 Other methods of determining $K_C$ or $R_{CH}$

The Society may for an individual ship, in lieu of the  $K_C$  or  $R_{CH}$  values defined above, approve the use of  $K_C$  values based on more exact calculations or  $R_{CH}$  values based on model tests. Such approval will be given on the understanding that it can be revoked if experience of the ship's performance in practice warrants this.

The design requirement for ice classes is a minimum speed of 5 knots in the following brash ice channels.

The values of  $H_M$  are those defined in Tab 4. A 0,1 m thick consolidated layer of ice for ice class **ICE CLASS IA SUPER** is to be considered.

**Table 4 : Values of  $H_M$**

Notation	$H_M$
<b>ICE CLASS IA SUPER</b> <b>ICE CLASS IA</b>	1,0
<b>ICE CLASS IB</b>	0,8
<b>ICE CLASS IC</b>	0,6



## SECTION 2

## HULL AND STABILITY

### Symbols

UIWL	: Upper ice waterline, defined in Ch 8, Sec 1, [2.1]
LIWL	: Lower ice waterline, defined in Ch 8, Sec 1, [2.1]
s	: Spacing, in m, of ordinary stiffeners or primary supporting members, as applicable
$\ell$	: Span, in m, of ordinary stiffeners or primary supporting members, as applicable
$R_{eH}$	: Minimum yield stress, in N/mm <sup>2</sup> , of the material as defined in Pt B, Ch 4, Sec 1, [2].
p	: Design ice pressure, in N/mm <sup>2</sup> , defined in [3.2.2]
h	: Height, in m, of load area defined in [3.2.1]
$t_c$	: Abrasion and corrosion addition, in mm, to be taken equal to 2 mm; where a special surface coating, shown by experience to be capable of withstanding the abrasion of ice, is applied, a lower value may be accepted by the Society on a case-by-case basis.
$\psi$	: Flare angle, in deg, taken equal to $\arctan(\tan \phi / \sin \alpha)$
$\alpha$	: Angle of the waterline at B/4, in deg
$\phi_1$	: Rake of the stem at the centreline, in deg, taken equal to 90 if the ship has a bulbous bow
$\phi_2$	: Rake of the bow at B/4, in deg

### 1 General

#### 1.1 Application

**1.1.1** For the purpose of the assignment of the notations **ICE CLASS IA SUPER**, **ICE CLASS IA**, **ICE CLASS IB**, **ICE CLASS IC** and **ICE CLASS ID**, the ship is divided into three regions defined in [1.2].

**1.1.2** The area to be strengthened are defined in [1.3] depending on the ice notation.

#### 1.1.3 Additional class notation ICE CLASS ID

Strengthening of ships with additional class notation **ICE CLASS ID** is that of bow region, rudder and steering arrangements of additional class notation **ICE CLASS IC**.

#### 1.1.4 Additional class notations YOUNG ICE 1 and YOUNG ICE 2

Ships with the additional class notation **YOUNG ICE 1** or **YOUNG ICE 2** are to comply with the requirements defined in [7].

The other articles of this Section are not applicable to notations **YOUNG ICE 1** and **YOUNG ICE 2**.

The miscellaneous requirements listed in Ch 8, Sec 3, [3] are also to be complied with.

### 1.2 Hull regions

#### 1.2.1 Bow region

The bow region is the region from the stem to a line parallel to and 0,04L aft of the forward borderline of the part of the hull where the waterlines run parallel to the centerline.

The overlap over the borderline need not exceed:

- 6 m for the notations **ICE CLASS IA SUPER** and **ICE CLASS IA**
- 5 m for the notations **ICE CLASS IB**, **ICE CLASS IC** and **ICE CLASS ID**.

#### 1.2.2 Midbody region

The midbody region is the region from the aft boundary of the bow region to a line parallel to and 0,04 L aft of the aft borderline of the part of the hull where the waterlines run parallel to the centerline.

The overlap over the borderline need not exceed:

- 6 m for the notations **ICE CLASS IA SUPER** and **ICE CLASS IA**
- 5 m for the notations **ICE CLASS IB** and **ICE CLASS IC**.

#### 1.2.3 Stern region

The stern region is the region from the aft boundary of the midbody region to the stern.

### 1.3 Ice strengthened area

#### 1.3.1 General

The vertical extension of the ice strengthened area (see Fig 1) is defined in:

- Tab 1 for plating (ice belt)
- Tab 2 for ordinary stiffeners and primary supporting members.

#### 1.3.2 Fore foot

The fore foot is the area below the ice belt extending from the stem to a position five ordinary stiffeners spacings aft of the point where the bow profile departs from the keel line (see Fig 1).

#### 1.3.3 Upper bow ice belt

The upper bow ice belt is the area extending from the upper limit of the ice belt to 2 m above and from the stem to a position at least 0,2 L aft of the forward perpendicular (see Fig 1).

**Table 1 : Vertical extension of ice strengthened area for plating (ice belt)**

Notation	Hull region	Vertical extension of ice strengthened area, in m	
		Above UIWL	Below LIWL
ICE CLASS IA SUPER	Bow	0,60	1,20
	Midbody		
	Stern		1,00
ICE CLASS IA	Bow	0,50	0,90
	Midbody		
	Stern		0,75
ICE CLASS IB ICE CLASS IC ICE CLASS ID	Bow	0,40	0,70
	Midbody		
	Stern		0,60
YOUNG ICE 1 YOUNG ICE 2	Bow	0,40	0,50

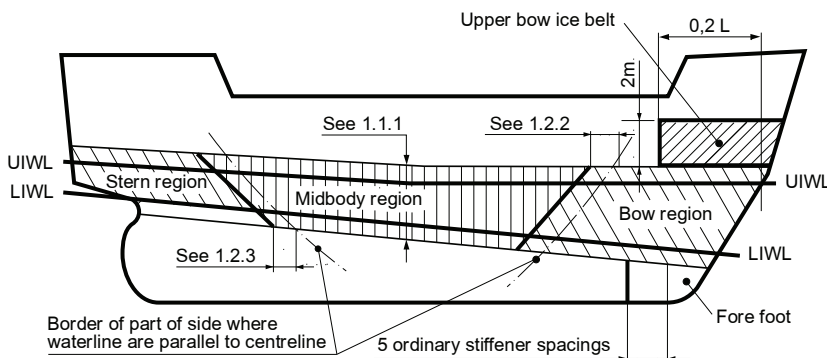
**Table 2 : Vertical extension of ice strengthening for ordinary stiffeners and primary supporting members**

Notation	Hull region	Vertical extension of ice strengthened area, in m	
		Above UIWL	Below LIWL
ICE CLASS IA SUPER	Bow	1,20	Down to tank top or below top of floors
	Midbody		2,00
	Stern		1,60
ICE CLASS IA ICE CLASS IB ICE CLASS IC ICE CLASS ID	Bow	1,00	1,60
Midbody	1,30		
Stern	1,00		
YOUNG ICE 1 YOUNG ICE 2	Bow	0,40	0,50

**Note 1:** Where an upper bow ice belt is required (see [4.2.1]), the ice-strengthened part of the framing is to be extended at least to the top of this ice belt.

**Note 2:** Where the ice strengthened area extends beyond a deck, the top or bottom plating of a tank or tank top by not more than 250 mm, it may be terminated at that deck, top or bottom plating of the tank or tank top.

**Figure 1 : Ice strengthened area and regions**



## 2 Structure design principles

### 2.1 General framing arrangement

**2.1.1** The frame spacings and spans in this Section are normally assumed to be measured along the plate and perpendicular to the axis of the stiffener for plates, along the flange for members with a flange, and along the free edge for flat bar stiffeners. For curved members the span (or spacing) is defined as the chord length between span (or spacing) points. The span points are defined by the intersection between the flange or upper edge of the member and the supporting structural element (stringer, web frame, deck or bulkhead).

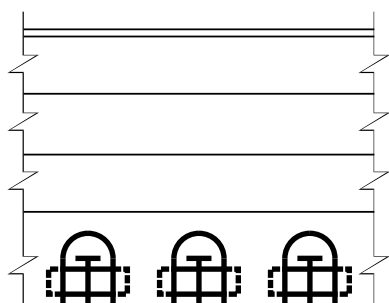
**2.1.2** The effective breadth of the attached plate to be used for calculating the combined section modulus of the stiffener, stringer and web frame and attached plate is to be taken as specified in Pt B, Ch 4, Sec 3, [3.2].

**2.1.3** The requirements for the section modulus and shear area of the ordinary stiffeners and the primary supporting members in [4.3] and [4.4] are with respect to effective member cross section. For such cases where the member is not normal to the plating, the section properties are to be adjusted in accordance with BV rules.

**2.1.4** Within the ice-strengthened area defined in [1.3], all ordinary stiffeners are to be effectively attached to all the supporting structures. A longitudinal ordinary stiffener is to be attached by brackets to all the supporting web frames and bulkheads. When a transverse ordinary stiffener terminates at a stringer or a deck, a bracket or a similar construction is to be fitted. Brackets are to have at least the same thickness as the web plate of the ordinary stiffener and the edge is to be appropriately stiffened against buckling.

When an ordinary stiffener is running through the supporting structure, both sides of the web plate of the ordinary stiffener are to be connected to the structure (by direct welding or collar plate, see example in Fig 2).

**Figure 2 : End connection of ordinary stiffener  
Two collar plates**



**2.1.5** Within the ice-strengthened area defined in [1.3], all ordinary stiffeners are to be attached to the shell by double continuous welds; no scalloping is allowed (except when crossing shell plate butts).

**2.1.6** Within the ice-strengthened area defined in [1.3], the web thickness of the frames is to be at least the maximum of the following:

- $\frac{h_w \sqrt{R_{eH}}}{C}$

where  $h_w$  is the web height and C is equal to 805 for profiles and 282 for flat bars

- half of the net thickness of the shell plating. For the purpose of calculating the web thickness of frames, the required thickness of the shell plating is to be calculated according to [4.2.2] using the yield strength  $R_{eH}$  of the frames
- 9 mm.

Where there is a deck, top or bottom plating of a tank, tank-top or bulkhead in lieu of a frame, the plate thickness of it is to be calculated as above, to a depth corresponding to the height of the adjacent frames. In such a case, the material properties of the deck, top or bottom plating of the tank, tank top or bulkhead and the frame height  $h_w$  of the adjacent frames are to be used in the calculations, and the constant C is to be taken equal to 805.

**2.1.7** Within the ice-strengthened area defined in [1.3], asymmetrical frames and frames which are not at right angles to the shell (web less than 90 degrees to the shell) are to be supported against tripping by brackets, intercostals, stringers or similar, at a distance not exceeding 1300 mm.

For frames with spans greater than 4 m, the extent of anti-tripping supports is to be applied to all regions and for all ice classes.

For frames with spans less than or equal to 4 m, the extent of antitripping supports is to be applied to all regions for **ICE CLASS IA SUPER**, to the bow and midbody regions for **ICE CLASS IA**, and to the bow region for **ICE CLASS IB**, **ICE CLASS IC** and **ICE CLASS ID**.

Direct calculation methods may be applied to demonstrate the equivalent level of support provided by alternative arrangements.

## 2.2 Transverse framing arrangement

### 2.2.1 Upper end of transverse framing

The upper end of the strengthened part of a main ordinary stiffener and intermediate ice ordinary stiffener is to be attached to a deck, top or bottom plating of a tank or an ice stringer as required in [4.4.1].

Where an intermediate ordinary stiffener terminates above a deck or an ice stringer which is situated at or above the upper limit of the ice belt, the part above the deck or stringer is to have the scantlings required for a non-ice strengthened ship. The upper end is to be connected to the adjacent main ordinary stiffeners by a horizontal member of the same scantlings as the main ordinary stiffener.

### 2.2.2 Lower end of transverse framing

The lower end of the strengthened part of a main ordinary stiffener and intermediate ice ordinary stiffener is to be attached to a deck, top or bottom plating of a tank, tank top or an ice stringer as required in [4.4.1].

Where an intermediate ordinary stiffener terminates below a deck, top or bottom plating of a tank, tank top or an ice stringer which is situated at or below the lower limit of the ice belt, the lower end is to be connected to the adjacent main ordinary stiffeners by a horizontal member of the same scantlings as the ordinary stiffeners.

## 2.3 Bilge keels

**2.3.1** The connection of bilge keels to the hull is to be so designed that the risk of damage to the hull, in the event of a bilge keel being ripped off, is minimised.

For this purpose, it is recommended that bilge keels are cut up into several shorter independent lengths.

## 3 Design loads

### 3.1 General

**3.1.1** Because of the different flexural stiffness of plating, ordinary stiffeners and primary supporting members, the ice load distribution is to be assumed to be as shown in Fig 3.

**3.1.2** The formulae and values given in this Section may be substituted by direct analysis if they are deemed by the Society to be invalid or inapplicable for a given structural arrangement or detail. Otherwise, direct analysis is not to be used as an alternative to the analytical procedures prescribed by explicit requirements.

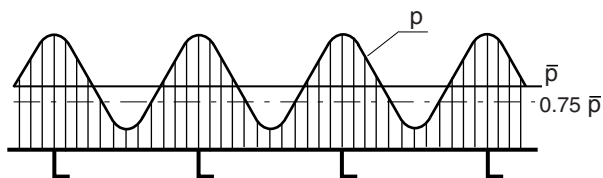
Direct analyses are to be carried out using the load patch ( $p$ ,  $h$  and  $\ell_a$ ). The pressure to be used is  $1,8p$ . The load patch is to be applied at locations where the capacity of the structure under the combined effects of bending and shear are minimized. In particular, the structure is to be checked with load centred at the UIWL,  $0,5 h_i$  below the LIWL, and positioned several vertical locations in between. Several horizontal locations are also to be checked, especially the locations centred at the mid-span or mid-spacing. Further, if the load length  $\ell_a$  cannot be determined directly from the arrangement of the structure, several values of  $\ell_a$  are to be checked using corresponding values for  $c_a$ .

Acceptance criterion for designs is that the combined stresses from bending and shear, using the von Mises yield criterion, are lower than the yield point  $R_{eH}$ . When the direct calculation is using beam theory, the allowable shear stress is not to be larger than  $0,9 \tau_v$ , where:

$$\tau_v = \frac{R_{eH}}{\sqrt{3}}$$

**3.1.3** If scantlings obtained from the requirements of this Section are less than those required for a ship that has not been ice strengthened, the latter are to be used.

**Figure 3 : Ice load distribution on ship side**



### 3.2 Ice loads

#### 3.2.1 Height of load area

The height of the area under ice pressure,  $h$ , at any particular point of time is to be obtained, in m, from Ch 8, Sec 1, Tab 2 depending on the additional class notation assigned to the ship.

#### 3.2.2 Design ice pressure

The value of the design ice pressure  $p$ , in  $N/mm^2$ , to be considered for the scantling check, is obtained from the following formula:

$$p = c_d c_p c_a p_o$$

where:

$c_d$  : Coefficient taking account of the influence of the size and engine output of the ship, to be obtained from the following formula:

$$c_d = \frac{a f + b}{1000}$$

without being more than 1.

$a, b$  : Coefficients defined in Tab 3

$f$  : Coefficient to be obtained from the following formula:

$$f = \frac{\sqrt{\Delta P}}{1000}$$

$P$  : Actual continuous output of propulsion machinery, in kW (see Ch 8, Sec 1, [3]) available when sailing in ice. If additional power sources are available for propulsion power (e.g. shaft

motors) in addition to the power of the main engine(s), they shall also be included in the total engine output used as the basis for hull scantling calculations. The engine output used for the calculation of the hull scantlings shall be clearly stated on the shell expansion drawing.

$\Delta$  : Displacement, in  $t$ , at the maximum ice class draught (see Ch 8, Sec 1, [2.1.1])

$c_p$  : Factor that reflects the magnitude of the load expected in the hull area in question relative to the bow area, defined in Tab 5

$c_a$  : Coefficient taking account of the probability that the full length of the area under consideration will be under pressure at the same time, to be obtained from the following formula:

$$c_a = \left( \frac{l_o}{l_a} \right)^{\frac{1}{2}}$$

without being taken less than 0,35 or greater than 1,0

$l_o$  : Distance, in m, taken equal to 0,6

$l_a$  : Distance, in m, defined in Tab 4

$p_o$  : Nominal ice pressure, in  $N/mm^2$ , to be taken equal to 5,6.

**Table 3 : Coefficients a, b**

Hull region	Condition	a	b
Bow	$f \leq 12$	30	230
	$f > 12$	6	518
Midbody Stern	$f \leq 12$	8	214
	$f > 12$	2	286

**Table 4 : Distance  $l_a$**

Structure	Type of framing	$l_a$
Shell plating	Transverse	Spacing of ordinary stiffeners
	Longitudinal	1,7 spacings of ordinary stiffeners
Ordinary stiffeners	Transverse	Spacing of ordinary stiffeners
	Longitudinal	Span of ordinary stiffeners
Vertical primary supporting members		Two spacings of vertical primary supporting members
Ice stringers		Span of stringers

**Table 5 : Coefficient  $c_p$**

Hull region	Notation						
	ICE CLASS IA SUPER	ICE CLASS IA	ICE CLASS IB	ICE CLASS IC	ICE CLASS ID	YOUNG ICE 1	YOUNG ICE 1
Bow	1,0	1,0	1,0	1,0	1,0	0,6	0,3
Midbody	1,0	0,85	0,70	0,50	not applicable		
Stern	0,75	0,65	0,45	0,25	not applicable		

## 4 Hull scantlings

### 4.1 Gross scantlings

**4.1.1** All scantlings referred to in this Article are gross, i.e. they include margin for corrosion and abrasion.

### 4.2 Plating

#### 4.2.1 General

The plating thickness is to be ice strengthened according to [4.2.2] within the strengthened area for plating defined in [1.3].

In addition, the plating thickness is to be strengthened in the following cases:

- For the notation **ICE CLASS IA SUPER**, the fore foot region is to be ice-strengthened in the same way as the bow region
- For the notations **ICE CLASS IA SUPER** or **ICE CLASS IA**, on ships with an open water service speed equal to or exceeding 18 knots, the upper bow ice belt is to be ice-strengthened in the same way as the midbody region. A similar strengthening of the bow region is to be considered for a ship with a lower service speed, when on the basis of the model tests, for example, it is evident that the ship will have a high bow wave.

#### 4.2.2 Plating thickness in the ice belt

The thickness of the shell plating is to be not less than the value obtained, in mm, from the following formulae:

- for transverse framing:

$$t = 667s \sqrt{\frac{F_1 p_{PL}}{R_{eH}}} + t_c$$

- for longitudinal framing:

$$t = 667s \sqrt{\frac{p}{F_2 R_{eH}}} + t_c$$

where:

$p_{PL}$  : Ice pressure on the shell plating to be obtained, in N/mm<sup>2</sup>, from the following formula:

$$p_{PL} = 0,75 p$$

$F_1$  : Coefficient to be obtained from the following formula:

$$F_1 = 1,3 - \frac{4,2}{\left[\frac{h}{s} + 1,8\right]^2}$$

without being taken greater than 1,0

$F_2$  : Coefficient to be obtained from the following formulae:

- for  $h/s \leq 1,0$ :

$$F_2 = 0,6 + 0,4 \frac{s}{h}$$

- for  $1,0 < h/s < 1,8$ :

$$F_2 = 1,4 - 0,4 \frac{h}{s}$$

### 4.3 Ordinary stiffeners

#### 4.3.1 General

Ordinary stiffeners are to be strengthened according to [4.3.2] within the icestrengthened area for ordinary stiffeners defined in [1.3].

Where less than 15% of the span  $\ell$  of the ordinary stiffener is situated within the ice-strengthening zone for ordinary stiffeners as defined in Tab 2, their scantlings may be determined according to Pt B, Ch 7, Sec 2 or NR600, as applicable.

#### 4.3.2 Scantlings of transverse ordinary stiffeners

The section modulus  $w$ , in cm<sup>3</sup> and the effective shear area  $A_{sh}$ , in cm<sup>2</sup>, of transverse ordinary stiffeners are to be not less than the values obtained from the following formulae:

$$w = \frac{7-5(h/\ell)}{7m_0} \frac{psh\ell}{R_{eH}} 10^6$$

$$A_{sh} = \frac{\sqrt{3}F_3 p h s}{2R_{eH}} 10^4$$

where:

$F_3$  : Coefficient which takes into account the maximum shear force versus the load location and the shear stress distribution and to be taken equal to 1,20

$m_0$  : Coefficient defined in Tab 6.

#### 4.3.3 Scantlings of longitudinal ordinary stiffeners

The section modulus  $w$ , in cm<sup>3</sup> and the effective shear area  $A_{sh}$ , in cm<sup>2</sup>, of longitudinal ordinary stiffeners with or without brackets are to be not less than the values obtained from the following formulae:

$$z = \frac{F_4 p h \ell^2}{m_1 R_{eH}} 10^6$$

$$A_{sh} = \frac{\sqrt{3}F_4 F_5 p h \ell}{2R_{eH}} 10^4$$

where:

$F_4$  : Coefficient, taking account of the load distribution on adjacent ordinary stiffeners, to be obtained from the following formula:

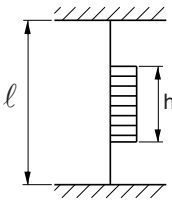
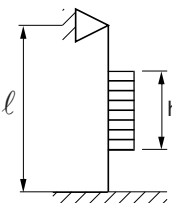
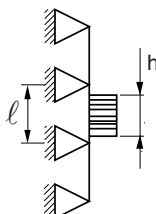
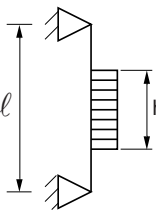
$$F_4 = \left(1 - 0,2 \frac{h}{s}\right)$$

$F_5$  : Coefficient which takes into account the pressure definition and maximum shear force versus load location and also shear stress distribution and to be taken equal to 2,16

$m_1$  : Boundary condition coefficient for the ordinary stiffener considered, to be taken equal to 13,3 for a continuous beam with brackets; where the boundary conditions deviate significantly from those of a continuous beam with brackets, e.g. in an end field, a smaller boundary condition coefficient may be required.

Note 1: In calculating the actual shear area of longitudinal ordinary stiffeners, the area of the brackets is not to be taken into account.

**Table 6 : Coefficient  $m_0$**

Boundary condition	Example	$m_0$
Type 1 	Frames in a bulk carrier with top wing tanks	7,0
Type 2 	Ordinary stiffeners extending from the tank top to a single deck	6,0
Type 3 	Continuous ordinary stiffeners between several decks or stringers	5,7
Type 4 	Ordinary stiffeners extending between two decks only	5,0

**Note 1:** The boundary conditions are those for the main and intermediate ordinary stiffeners.  
**Note 2:** Load is applied at mid-span.

## 4.4 Primary supporting members

### 4.4.1 Ice stringers

The section modulus  $w$ , in  $\text{cm}^3$  and the effective section area  $A_{Sh}$ , in  $\text{cm}^2$ , of an ice stringer are to be not less than the values obtained from the following formulae:

$$w = \frac{F_6 F_7 p h \ell^2}{m_s R_{eH}} 10^6$$

$$A_{Sh} = \frac{\sqrt{3} F_6 F_7 F_8 p h \ell}{2 R_{eH}} 10^4$$

where:

$h$  : Height, in m, of load area defined in [3.2.1], without the product  $ph$  being taken less than 0,15 MN/m.

$m_s$  : Boundary condition coefficient for the ordinary stiffener considered, to be taken equal to 13,3 for a continuous beam; where the boundary conditions deviate significantly from those of a continuous beam, e.g. in an end field, a smaller boundary condition coefficient may be required. In such a case, for girders without brackets, a value of  $m = 11,0$  is to be used

$F_6$  : Factor that takes into account the distribution of load to the transverse frames, to be taken equal to:

- for ice stringers within the ice belt,  $F_6 = 0,90$
- for ice stringers outside the ice belt,  $F_6 = 0,80 (1 - h_s / \ell_s)$

$F_7$  : Factor that takes into account the design point of girders to be taken equal to 1,80

$F_8$  : Factor that takes into account the maximum shear force versus load location and the shear stress distribution to be taken equal to 1,20

$h_s$  : Distance to the ice belt as defined in Tab 1, in m

$\ell_s$  : Distance to the adjacent ice stringer, in m.

### 4.4.2 Vertical primary supporting member checked through simplified model

For vertical primary supporting members which may be represented by the structure model represented in Fig 4, the section modulus  $w$ , in  $\text{cm}^3$ , and the effective shear area  $A_{Sh}$ , in  $\text{cm}^2$ , are to be not less than the values obtained from the following formulae:

$$w = \frac{M}{R_{eH}} \left( \frac{1}{1 - (v A_{Sh1} / A_a)^2} \right)^{\frac{1}{2}} 10^3$$

$$A_{Sh} = 10 \frac{\sqrt{3} F_9 \alpha Q}{R_{eH}}$$

where:

$F$  : Load transferred to a vertical primary supporting member from a stringer or from longitudinal ordinary stiffeners, to be obtained, in kN, from the following formula:

$$F = F_{10} p h s 10^3$$

$F_{10}$  : Factor that takes into the design point of girders to be taken equal to:

- for vertical primary supporting members within the ice belt,  $F_{10} = 1,80$
- for vertical primary supporting members outside the ice belt,  $F_{10} = 1,80 (1 - h_s / \ell_s)$ , where  $h_s$  and  $\ell_s$  are to be taken as defined in [4.4.1]

$F_9$  : Factor that takes into account the shear force distribution to be taken equal to 1,1

$Q$  : Maximum calculated shear force, in kN, under the ice load  $F$

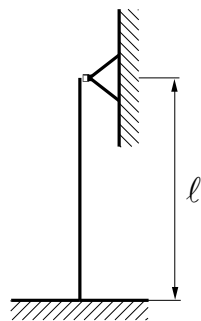
$M$  : Maximum calculated bending moment, in kN.m, under the ice load  $F$  to be taken equal to  $M = 0,193 F \ell$

$v$  : Coefficient defined in Tab 7

$\alpha$  : Coefficient defined in Tab 7

- p : Design ice pressure, in N/mm<sup>2</sup>, defined in [3.2.2], where the value of  $c_a$  is to be calculated assuming  $\ell_a$  equal to 2S
- S : Distance between web frames, in m
- h : Height, in m, of load area defined in [3.2.1], without the product ph being taken less than 0,15 MN/m.
- $A_{Sh1}$  : Required shear area, in cm<sup>2</sup>
- $A_a$  : Actual cross-sectional area, in cm<sup>2</sup> of the vertical primary supporting member, to be taken equal to  $A_F + A_W$

**Figure 4 : Reference structure model**



**Table 7 : Coefficients  $\alpha, v$**

$A_F/A_W$	$\alpha$	$v$
0,20	1,23	0,44
0,40	1,16	0,62
0,60	1,11	0,71
0,80	1,09	0,76
1,00	1,07	0,80
1,20	1,06	0,83
1,40	1,05	0,85
1,60	1,05	0,87
1,80	1,04	0,88
2,00	1,04	0,89

**Note 1:**  
 $A_F$  : Cross-sectional area of the face plate  
 $A_W$  : Cross-sectional area of the web.

## 5 Other structures

### 5.1 Application

5.1.1 The requirements in [5.3] and [5.4] do not apply for the assignment of the **ICE CLASS ID**.

### 5.2 Fore part

#### 5.2.1 Stem

The stem may be made of rolled, cast or forged steel or of shaped steel plates (see Fig 5).

The plate thickness of a shaped plate stem and, in the case of a blunt bow, any part of the shell where  $\alpha \geq 30^\circ$  and  $\psi \geq$

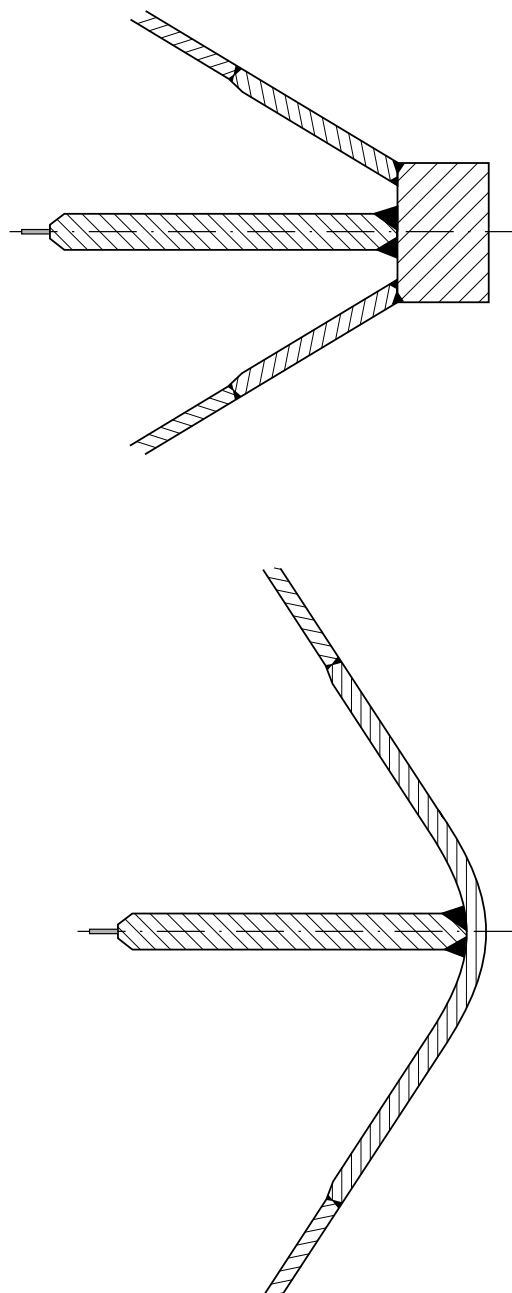
$75^\circ$ , is to be not less than that calculated in [4.2.2] assuming that:

- s is the spacing of elements supporting the plate, in m
- $p_{PL}$ , in N/mm<sup>2</sup>, is taken equal to p, defined in [3.2.2], with  $\ell_a$  being the spacing of vertical supporting elements, in m.

The stem and the part of a blunt bow defined above are to be supported by floors or brackets spaced not more than 600 mm apart and having a thickness at least half that of the plate.

The reinforcement of the stem is to be extended from the keel to a point 0,75 m above the UIWL or, where an upper fore ice belt is required (see [1.3]), to the upper limit of the latter.

**Figure 5 : Example of suitable stems**



### 5.3 Aft part

**5.3.1** In order to avoid very high load on propeller blade tips, the minimum distance between propeller(s) and hull (including stern frame) should not be less than  $h_i$  as defined in Ch 8, Sec 1, Tab 2.

**5.3.2** On twin and triple screw ships, the ice strengthening of the shell and framing is to be extended to the tank top for at least 1,5 m forward and aft of the side propellers.

**5.3.3** Shafting and sterntubes of side propellers are generally to be enclosed within plated bossings. If detached struts are used, their design, strength and attachment to the hull are to be examined by the Society on a case-by-case basis.

### 5.4 Deck strips and hatch covers

**5.4.1** Narrow deck strips abreast of hatches and serving as ice stringers are to comply with the section modulus and shear area calculated in [4.4.1], respectively. In the case of very long hatches, the product  $ph$  is to be taken less than 0,30 but in no case less than 0,20.

Special attention is to be paid when designing weather deck hatch covers and their fittings to the deflection of the ship sides due to ice pressure in way of very long hatch openings.

### 5.5 Sidescuttles and freeing ports

**5.5.1** Sidescuttles are not to be located in the ice belt.

**5.5.2** Freeing ports are to be given at least the same strength as is required for the shell in the ice belt.

## 6 Hull outfitting

### 6.1 Rudders and steering arrangements

**6.1.1** The scantlings of the rudder post, rudder stock, pintles, steering gear, etc. as well as the capacity of the steering gear are to be determined according to Pt B, Ch 9, Sec 1 in the two following conditions:

- Maximum ahead service speed
- Reference speed indicated in Tab 8, with the coefficients  $r_1$  and  $r_2$ , as defined in Pt B, Ch 9, Sec 1, [2.1.2] taken equal to 1,0 irrespective of the rudder type profile.

Within the ice strengthened zone, the thickness of rudder plating and diaphragms is to be not less than that required for the shell plating of the stern region.

**Table 8 : Reference speed**

Notation	Reference speed (knots)
ICE CLASS IA SUPER	20
ICE CLASS IA	18
ICE CLASS IB	16
ICE CLASS IC ICE CLASS ID	14

**6.1.2** For the notations **ICE CLASS IA SUPER** or **ICE CLASS IA**, the rudder stock and the upper edge of the rudder are to be protected against ice pressure by an ice knife or equivalent means.

### 6.2 Bulwarks

**6.2.1** If the weather deck in any part of the ship is situated below the upper limit of the ice belt (e.g. in way of the well of a raised quarter deck), the bulwark is to be reinforced at least to the standard required for the shell in the ice belt.

## 7 Additional class notations YOUNG ICE 1 and YOUNG ICE 2

### 7.1 Area to be strengthened

#### 7.1.1 Region

For the purpose of the assignment of the notations **YOUNG ICE 1** and **YOUNG ICE 2**, only the bow region of the ship, as defined in [1.2.1], is to be strengthened.

#### 7.1.2 Vertical extension

The vertical extension of the ice strengthened area is defined in Tab 1 for plating (ice belt) and in Tab 2 for ordinary stiffeners and primary supporting members

### 7.2 Design loads

#### 7.2.1 Height of the ice load area

A ship strengthened for assignment of additional class notation **YOUNG ICE 1** or **YOUNG ICE 2** is assumed to operate in conditions corresponding to ice thickness not exceeding the value  $h_i$ .

The design ice load height  $h$  of the area under ice pressure at any time is assumed to be only a fraction of the ice thickness.

The values for  $h_i$  and  $h$ , in m, are given in Ch 8, Sec 1, Tab 2.

#### 7.2.2 Ice loads

The design ice pressure  $p$ , in N/mm<sup>2</sup>, is to be calculated according to [3.2], with the nominal ice pressure,  $p_0$ , to be taken equal to 3,0.

### 7.3 Plating

#### 7.3.1 General

If the scantlings obtained from [7.3.2] are less than those required for the unstrengthened ship, the latter are to be used.

The scantling formulae defined in [7.3.2] are based on simply supported boundary conditions to take into account non-homogeneous ice loads. Different boundary conditions will be considered on a case-by-case basis.



### 7.3.2 Plating thickness in the ice belt

The thickness of the shell plating made of steel or aluminium is to be not less than the value obtained, in mm, from the following formulae:

- for transverse framing:

$$t = 27,4s \sqrt{\frac{F_1 p_{pl} 10^3}{R}} + t_c$$

- for longitudinal framing:

$$t = 27,4 \sqrt{\frac{p_{pl} h (2s - h) 10^3}{F_2 R}} + t_c$$

where:

$p_{pl}$  : Ice pressure on the shell plating, in N/mm<sup>2</sup>, to be taken equal to 0,75 p

$F_1$  : Coefficient to be obtained from the following formula:

$$F_1 = 1,3 - \frac{4,2}{\left[\frac{h}{s} + 1,8\right]^2}$$

without being taken greater than 1,0

$F_2$  : Coefficient to be obtained from the following formulae:

- for  $h/s \leq 1,0$ :

$$F_2 = 0,6 + 0,4 \frac{s}{h}$$

- for  $1,0 < h/s < 1,8$ :

$$F_2 = 1,4 - 0,4 \frac{h}{s}$$

$R$  : Minimum yield stress value of the material, in N/mm<sup>2</sup>, taken equal to:

- for steel:

$$R = R_{eH} \text{ as defined in Pt B, Ch 4, Sec 1, [2]}$$

- for aluminium:

$$R = R'_{p0,2} \text{ as defined in Pt B, Ch 4, Sec 1, [4]}$$

$t_c$  : Abrasion and corrosion addition, in mm, to be taken equal to 2 mm for steel and aluminium; where a special surface coating, shown by experience to be capable of withstanding the abrasion of ice, is applied, a lower value may be accepted by the Society on a case-by-case basis.

## 7.4 Ordinary stiffeners and primary supporting members

### 7.4.1 General

If the scantlings obtained from [7.4.2] and [7.4.3] are less than those required for the unstrengthened ship, the latter are to be used.

The scantling formulae defined in [7.4.2] and [7.4.3] are based on simply supported boundary conditions to take into account non-homogeneous ice loads. Direct calculation approach may be considered for different boundary conditions.

Where less than 15% of the span  $\ell$  of an ordinary stiffener or a primary supporting member is located within the ice-strengthening zone defined in [7.1], their scantlings may be determined according to the applicable requirements for the unstrengthened ship or by direct calculation.

The effective shear section of welded connections between secondary stiffeners and primary supporting members is to be not less than the  $A_{sh}$  values calculated in [7.4.2] or [7.4.3], as relevant. When these criteria cannot be fulfilled, brackets or collar plates are to be fitted.

### 7.4.2 Scantlings of transverse stiffeners

The section modulus  $W$ , in cm<sup>3</sup>, and the effective shear area  $A_{sh}$ , in cm<sup>2</sup>, of transverse stiffeners within the ice belt and subject to ice loads are to be not less than the values obtained from the following formulae:

$$W = \frac{p h s (2\ell - h) 10^6}{8R}$$

$$A_{sh} = \frac{10 p s h}{0,6R} 10^3$$

where:

$R$  : Minimum yield stress value of the material, in N/mm<sup>2</sup>, taken equal to:

- for steel:

$$R = R_{eH} \text{ as defined in Pt B, Ch 4, Sec 1, [2]}$$

- for aluminium:

$$R = R'_{p0,2} \text{ as defined in Pt B, Ch 4, Sec 1, [4].}$$

### 7.4.3 Scantlings of longitudinal stiffeners

The section modulus  $W$ , in cm<sup>3</sup>, and the effective shear area  $A_{sh}$ , in cm<sup>2</sup>, of longitudinal stiffeners within the ice belt and subject to ice loads are to be not less than the values obtained from the following formulae:

$$W = \frac{p h \ell^2 10^6}{8R}$$

$$A_{sh} = \frac{5 p h \ell}{0,6R} 10^3$$

## 7.5 Sidescuttles and freeing ports

**7.5.1** Sidescuttles are not to be located in the ice belt.

**7.5.2** Freeing ports are to be given at least the same strength as the one required for the shell in the ice belt.

## SECTION 3

## MACHINERY

## Symbols

$c$	: Chord length of blade section, in m	$P_{0,7n}$	: Propeller pitch at 0,7 R radius at MCR in free running open water condition, in m
$c_{0,7}$	: Chord length of blade section at 0,7R propeller radius, in m	$Q$	: Torque, in kN·m
CP	: Controllable pitch	$Q_{\text{emax}}$	: Maximum engine torque, in kN·m. If not known, $Q_{\text{emax}}$ is to be taken equal to the values given in Tab 10
D	: Propeller diameter, in m	$Q_{\text{max}}$	: Maximum torque on the propeller resulting from propeller/ice interaction, in kN·m. See Tab 3
d	: External diameter of propeller hub (at propeller plane), in m	$Q_{\text{max}}^n$	: Maximum torque on the propeller resulting from propeller/ice interaction reduced to the rotational speed in question, in kN·m
$D_{\text{limit}}$	: Limit value for propeller diameter, in m	$Q_{\text{motor}}$	: Electric motor peak torque, in kN·m
EAR	: Expanded blade area ratio	$Q_n$	: Nominal torque at MCR in free running open water condition, in kN·m
$F_b$	: Maximum backward blade force during the ship's service life, in kN. See Tab 3	$Q_{\text{peak}}$	: Maximum of the response torque $Q_r$ , in kN·m
$F_{\text{ex}}$	: Ultimate blade load resulting from blade loss through plastic bending, in kN. See Tab 3	$Q_r$	: Maximum response torque along the propeller shaft line, in kN·m. See Tab 3
$F_f$	: Maximum forward blade force during the ship's service life, in kN. See Tab 3	$Q_{\text{sex}}$	: Maximum spindle torque due to blade failure caused by plastic bending, in kN·m.
$F_{\text{ice}}$	: Ice load, in kN	$Q_{\text{smax}}$	: Maximum spindle torque of the blade during the ship's service life, in kN·m. See Tab 3
$(F_{\text{ice}})_{\text{max}}$	: Maximum ice load during the ship's service life, in kN	$Q_{\text{vib}}$	: Vibratory torque at considered component, taken from frequency domain open water torque vibration calculation (TVC), in kN·m
FP	: Fixed pitch	R	: Propeller radius, in m
$H_{\text{ice}}$	: Thickness of maximum design ice block entering the propeller, in m	r	: Blade section radius, in m
$I_e$	: Equivalent mass moment of inertia of all parts on engine side of the component under consideration, in kg·m <sup>2</sup>	T	: Propeller thrust, in kN
$I_t$	: Equivalent mass moment of inertia of the whole propulsion system, in kg·m <sup>2</sup>	$T_b$	: Maximum backward propeller ice thrust during the ship's service life, in kN. See Tab 3
k	: Shape parameter for Weibull distribution	$T_f$	: Maximum forward propeller ice thrust during the ship's service life, in kN. See Tab 3
LIWL	: Lower ice waterline, in m	$T_n$	: Nominal propeller thrust at MCR in free running open water condition, in kN
m	: Slope for SN curve in log/log scale	$T_r$	: Maximum response thrust along the shaft line, in kN. See Tab 3
$M_{\text{BL}}$	: Blade bending moment, in kN·m	t	: Maximum blade section thickness
MCR	: Maximum continuous rating	Z	: Number of propeller blades
n	: Rotational propeller speed in bollard condition, in rev/s. If not known, n is to be taken equal to the values given in Tab 7	$\alpha_1$	: Phase angle of propeller ice torque for blade order excitation component, in degrees
$n_n$	: Nominal rotational propeller speed at MCR in free running open water condition, in rev/s	$\alpha_2$	: Phase angle of propeller ice torque for twice the blade order excitation component, in degrees
$N_{\text{class}}$	: Reference number of impacts per nominal propeller rotational speed per ice class	$\alpha_i$	: Duration of propeller blade/ice interaction expressed in rotation angle, in degrees
$N_{\text{ice}}$	: Total number of ice loads on propeller blade during the ship's service life	$\gamma_{e1}$	: Reduction factor for fatigue; scatter effect (equal to one standard deviation)
$N_R$	: Reference number of load for equivalent fatigue stress ( $10^8$ cycles)	$\gamma_{e2}$	: Reduction factor for fatigue; test specimen size effect
$N_Q$	: Number of propeller revolutions during a milling sequence		
$P_{0,7}$	: Propeller pitch at 0,7 R radius, in m. If not known, $P_{0,7}$ is to be taken equal to 0,7 $P_{0,7n}$		

$\gamma_v$	: Reduction factor for fatigue; variable amplitude loading effect
$\gamma_m$	: Reduction factor for fatigue; mean stress effect
$\rho$	: Reduction factor for fatigue correlating the maximum stress amplitude to the equivalent fatigue stress for $10^8$ stress cycles
$\sigma_{0,2}$	: Minimum yield or 0,2% proof strength of blade material, in MPa, to be specified on the drawing.
$\sigma_{exp}$	: Mean fatigue strength of blade material at $10^8$ cycles to failure in sea water, in MPa
$\sigma_{fat}$	: Equivalent fatigue ice load stress amplitude for $10^8$ stress cycles, in MPa
$\sigma_{fl}$	: Characteristic fatigue strength for blade material, in MPa
$\sigma_{ref}$	: Reference stress, in MPa: $\sigma_{ref} = 0,6 \sigma_{0,2} + 0,4 \sigma_u$
$\sigma_{ref2}$	: Reference stress, in MPa: $\sigma_{ref2} = 0,7 \sigma_u$ or $\sigma_{ref2} = 0,6 \sigma_{0,2} + 0,4 \sigma_u$ , whichever is less
$\sigma_{st}$	: Maximum stress resulting from $F_b$ or $F_f$ , in MPa
$\sigma_u$	: Ultimate tensile strength of blade material, in MPa, to be specified on the drawing.
$(\sigma_{ice})_{bmax}$	: Principal stress caused by the maximum backward propeller ice load, in MPa
$(\sigma_{ice})_{imax}$	: Principal stress caused by the maximum forward propeller ice load, in MPa
$(\sigma_{ice})_{max}$	: Maximum ice load stress amplitude, in MPa.
$\phi$	: Rotation angle, in deg, from when the first impact occurs.

## 1 Requirements for propulsion machinery of the class notation ICE CLASS IA SUPER, ICE CLASS IA, ICE CLASS IB and ICE CLASS IC

### 1.1 Scope

**1.1.1** These regulations apply to propulsion machinery covering open- and ducted-type propellers with controllable pitch or fixed pitch design for the class notations **ICE CLASS IA SUPER, ICE CLASS IA, ICE CLASS IB** and **ICE CLASS IC**.

The given loads are the expected ice loads for the whole ship's service life under normal operational conditions, including loads resulting from the changing rotational direction of FP propellers.

However, these loads do not cover off-design operational conditions, for example when a stopped propeller is dragged through ice.

The regulations also apply to azimuthing and fixed thrusters for main propulsion, considering loads resulting from propeller-ice interaction and loads on the thruster body/ice interaction.

The given azimuthing thruster body loads are the expected ice loads during the ship's service life under normal opera-

tional conditions. The local strength of the thruster body shall be sufficient to withstand local ice pressure when the thruster body is designed for extreme loads.

However, the load models of the regulations do not include propeller/ice interaction loads when ice enters the propeller of a turned azimuthing thruster from the side (radially)

The thruster global vibrations caused by blade order excitation on the propeller may cause significant vibratory loads.

### 1.2 Design ice conditions

**1.2.1** In estimating the ice loads of the propeller for ice classes, different types of operation as given in Tab 1 were taken into account. For the estimation of design ice loads, a maximum ice block size is determined. The maximum design ice block entering the propeller is a rectangular ice block with the dimensions  $H_{ice} \cdot 2H_{ice} \cdot 3H_{ice}$ .

The thickness of the ice block ( $H_{ice}$ ) is given in Tab 2.

### 1.3 Materials

#### 1.3.1 Materials exposed to sea water

Materials of components exposed to sea water, such as propeller blades, blade bolts, propeller hubs, and thruster body, are to have an elongation of not less than 15% on a test specimen, the gauge length of which is five times the diameter. A Charpy V impact test is to be carried out for materials other than bronze and austenitic steel. An average impact energy value of 20 J taken from three tests is to be obtained at minus 10°C. For nodular cast iron, average impact energy of 10 J at minus 10°C is required accordingly.

#### 1.3.2 Materials exposed to sea water temperature

Materials exposed to sea water temperature shall be of ductile material. An average impact energy value of 20 J taken from three tests is to be obtained at minus 10°C. This requirement applies to the propeller shaft, CP mechanisms, shaft bolts, strut-pod connecting bolts etc. This does not apply to surface hardened components, such as bearings and gear teeth. The nodular cast iron of a ferrite structure type may be used for relevant parts other than bolts. The average impact energy for nodular cast iron is to be a minimum of 10 J at minus 10°C.

**Table 1 : Types of operation**

Notation	Operation of the ship
<b>ICE CLASS IA SUPER</b>	Operation in ice channels and in level ice The ship may proceed by ramming
<b>ICE CLASS IA ICE CLASS IB ICE CLASS IC</b>	Operation in ice channels

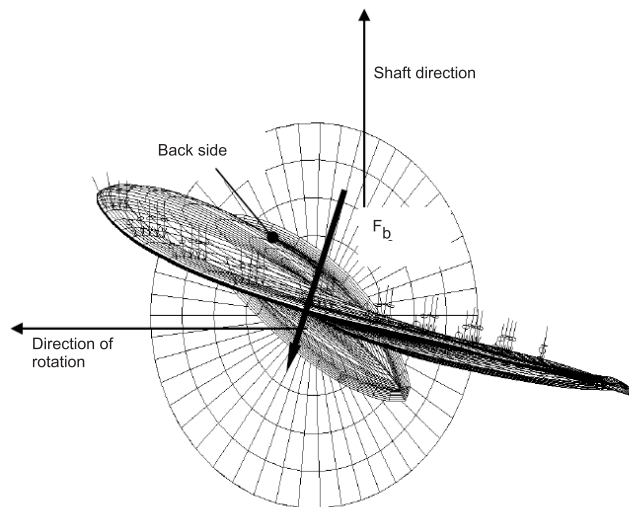
**Table 2 : Thickness of the ice block ( $H_{ice}$ )**

<b>ICE CLASS IA SUPER</b>	<b>ICE CLASS IA</b>	<b>ICE CLASS IB</b>	<b>ICE CLASS IC</b>
1,75 m	1,5 m	1,2 m	1,0 m

**Table 3 : Definition of loads**

	Definition	Use of the load in design process
$F_b$	The maximum lifetime backward force on a propeller blade resulting from propeller/ice interaction, including hydrodynamic loads on that blade. The direction of the force is perpendicular to 0.7R chord line. See Fig 1	Design force for strength calculation of the propeller blade
$F_f$	The maximum lifetime forward force on a propeller blade resulting from propeller/ice interaction, including hydrodynamic loads on that blade. The direction of the force is perpendicular to 0,7R chord line	Design force for strength calculation of the propeller blade
$Q_{smax}$	The maximum lifetime spindle torque on a propeller blade resulting from propeller/ice interaction, including hydrodynamic loads on that blade	When designing the propeller strength, the spindle torque is automatically taken into account because the propeller load is acting on the blade as distributed pressure on the leading edge or tip area
$T_b$	The maximum lifetime thrust on propeller (all blades) resulting from propeller/ice interaction. The direction of the thrust is the propeller shaft direction and the force is opposite to the hydrodynamic thrust	Is used for estimating of the response thrust $T_r$ $T_b$ can be used as an estimate of excitation in axial vibration calculations. However, axial vibration calculations are not required by the rules
$T_f$	The maximum lifetime thrust on propeller (all blades) resulting from propeller/ice interaction. The direction of the thrust is the propeller shaft direction acting in the direction of hydrodynamic thrust	Is used for estimating of the response thrust $T_r$ $T_f$ can be used as an estimate of excitation in axial vibration calculations. However, axial vibration calculations are not required by the rules
$Q_{max}$	The maximum ice-induced torque resulting from propeller/ice interaction on one propeller blade, including hydrodynamic loads on that blade	Is used for estimating of the response torque ( $Q_r$ ) along the propulsion shaft line and as excitation for torsional vibration calculations
$F_{ex}$	Ultimate blade load resulting from blade loss through plastic bending. The force that is needed to cause total failure of the blade so that plastic hinge appear in the root area. The force is acting on 0,8R. The spindle arm is 2/3 of the distance between the axis of blade rotation and leading/trailing edge (whichever is the greater) at the 0,8R radius	Blade failure load is used to dimension the blade bolts, pitch control mechanism, propeller shaft, propeller shaft bearing and trust bearing. The objective is to guarantee that total propeller blade failure does not lead to damage to other components
$Q_r$	Maximum response torque along the propeller shaft line, taking into account the dynamic behavior of the shaft line for ice excitation (torsional vibration) and hydrodynamic mean torque on propeller	Design torque for propeller shaft line components
$T_r$	Maximum response thrust along shaft line, taking into account the dynamic behavior of the shaft line for ice excitation (axial vibration) and hydrodynamic mean thrust on propeller	Design thrust for propeller shaft line components
$F_{ti}$	Maximum response force caused by ice block impacts on the thruster body or the propeller hub	Design load for thruster body and slewing bearings.
$F_{tr}$	Maximum response force on the thruster body caused by ice ridge/thruster body interaction	Design load for thruster body and slewing bearings

**Figure 1 : Direction of the backward blade force resultant taken perpendicular to chord line at radius 0,7R**



Ice contact pressure at leading edge is shown with small arrows

## 1.4 Design loads

**1.4.1** The given loads are intended for component strength calculations only and are total loads including ice-induced loads and hydrodynamic loads during propeller/ice interaction. The presented maximum loads are based on a worst case scenario that occurs once during the service life of the ship. Thus, the load level for a higher number of loads is lower. The values of the parameters in the formulae in this section shall be given in the units shown in the symbol list. If the highest point of the propeller is not at a depth of at least  $h_i$  below the water surface when the ship is in ballast condition, the propulsion system shall be designed according to ice class **ICE CLASS IA** for ice classes **ICE CLASS IB** and **ICE CLASS IC**

### 1.4.2 Design loads on propeller blades

$F_b$  is the maximum force experienced during the lifetime of the ship that bends a propeller blade backwards when the propeller mills an ice block while rotating ahead.  $F_f$  is the maximum force experienced during the lifetime of the ship that bends a propeller blade forwards when the propeller mills an ice block while rotating ahead.  $F_b$  and  $F_f$  originate from different propeller/ice interaction phenomena, not acting simultaneously. Hence they are to be applied to one blade separately.

a) Maximum backward blade force  $F_b$  for open propellers

- when  $D \leq D_{\text{limit}}$

$$F_b = 27(nD)^{0.7} \left(\frac{\text{EAR}}{Z}\right)^{0.3} D^2$$

- when  $D > D_{\text{limit}}$

$$F_b = 23(nD)^{0.7} \left(\frac{\text{EAR}}{Z}\right)^{0.3} D H_{\text{ice}}^{1.4}$$

where:

$$D_{\text{limit}} = 0,85 H_{\text{ice}}^{1.4}$$

b) Maximum forward blade force  $F_f$  for open propellers

- when  $D \leq D_{\text{limit}}$

$$F_f = 250 \left(\frac{\text{EAR}}{Z}\right) D^2$$

- when  $D > D_{\text{limit}}$

$$F_f = 500 \left(\frac{\text{EAR}}{Z}\right) D \frac{1}{\left(1 - \frac{d}{D}\right)} H_{\text{ice}}$$

where:

$$D_{\text{limit}} = \frac{2}{\left(1 - \frac{d}{D}\right)} H_{\text{ice}}$$

c) Loaded area on the blade for open propellers

Load cases 1-4 have to be covered, as given in Tab 4 below, for CP and FP propellers. In order to obtain blade ice loads for a reversing propeller, load case 5 also has to be covered for FP propellers.

d) Maximum backward blade ice force  $F_b$  for ducted propellers

- when  $D \leq D_{\text{limit}}$

$$F_b = 9,5(nD)^{0.7} \left(\frac{\text{EAR}}{Z}\right)^{0.3} D^2$$

- when  $D > D_{\text{limit}}$

$$F_b = 66(nD)^{0.7} \left(\frac{\text{EAR}}{Z}\right)^{0.3} D^{0.6} H_{\text{ice}}^{1.4}$$

where:

$$D_{\text{limit}} = 4 H_{\text{ice}}$$

e) Maximum forward blade ice force  $F_f$  for ducted propellers

- when  $D \leq D_{\text{limit}}$

$$F_f = 250 \left(\frac{\text{EAR}}{Z}\right) D^2$$

- when  $D > D_{\text{limit}}$

$$F_f = 500 \left(\frac{\text{EAR}}{Z}\right) D \frac{1}{\left(1 - \frac{d}{D}\right)} H_{\text{ice}}$$

where:

$$D_{\text{limit}} = \frac{2}{\left(1 - \frac{d}{D}\right)} H_{\text{ice}}$$

f) Loaded area on the blade for ducted propellers

Load cases 1 and 3 have to be covered as given in Tab 5 for all propellers, and an additional load case (load case 5) for an FP propeller, to cover ice loads when the propeller is reversed.

g) Maximum blade spindle torque  $Q_{\text{smax}}$  for open and ducted propellers

The spindle torque  $Q_{\text{smax}}$  around the axis of the blade fitting shall be determined both for the maximum backward blade force  $F_b$  and forward blade force  $F_f$ , which are applied as in Tab 4 and Tab 5. The larger of the obtained torques is used as the dimensioning torque. If the above method gives a value which is less than the default value given by the formula below, the default value shall be used:

$$Q_{\text{smax}} = 0,25 F c_{0,7}$$

where:

$F$  : Either  $F_b$  or  $F_f$ , whichever has the greater absolute value.

h) Load distributions for blade loads

The Weibull-type distribution (probability that  $F_{\text{ice}}$  exceeds  $(F_{\text{ice}})_{\text{max}}$ ), as given in Fig 2, is used for the fatigue design of the blade.

$$P\left(\frac{F_{\text{ice}}}{(F_{\text{ice}})_{\text{max}}} \geq \frac{F}{(F_{\text{ice}})_{\text{max}}}\right) = e^{-\left[\frac{F}{(F_{\text{ice}})_{\text{max}}}\right]^k \ln(N_{\text{ice}})}$$

where:

$k$  : Shape parameter of the spectrum  
 The shape parameter  $k = 0,75$  is to be used for the ice force distribution of an open propeller

The shape parameter  $k = 1,0$  is to be used for that of a ducted propeller blade

$N_{ice}$  : Number of load cycles in the load spectrum (see item i))

$F_{ice}$  : Random variable for ice loads on the blade:  
 $0 \leq F_{ice} \leq (F_{ice})_{max}$

i) Number of ice loads

The number of load cycles per propeller blade in the load spectrum shall be determined according to the formula:

$$N_{ice} = k_1 k_2 k_3 k_4 N_{class} n$$

where:

$N_{class}$  : Reference number of loads for notations:

- for **ICE CLASS IA Super**:  $N_{class} = 9 \cdot 10^6$
- for **ICE CLASS IA**:  $N_{class} = 6 \cdot 10^6$
- for **ICE CLASS IB**:  $N_{class} = 3,4 \cdot 10^6$
- for **ICE CLASS IC**:  $N_{class} = 2,1 \cdot 10^6$

$k_1$  : Propeller location factor:

- for a center propeller:  $k_1 = 1,0$
- for a wing propeller:  $k_1 = 1,35$

$k_2$  : Propeller type factor:

- for an open propeller:  $k_2 = 1,0$
- for a ducted propeller:  $k_2 = 1,1$

$k_3$  : Propulsion type factor:

- for a fixed propulsor:  $k_3 = 1,0$
- for an azimuthing propulsor:  $k_3 = 1,2$

$k_4$  : Submersion factor:

- for  $f < 0$ :  $k_4 = 0,8 - f$
- for  $0 \leq f \leq 1$ :  $k_4 = 0,8 - 0,4 f$
- for  $1 < f \leq 2,5$ :  $k_4 = 0,6 - 0,2 f$
- for  $f > 2,5$ :  $k_4 = 0,1$

$f$  : Immersion factor:

$$f = \frac{h_0 - H_{ice}}{\frac{D}{2}} - 1$$

$h_0$  : Depth of the propeller centreline at the lower ice waterline (LIWL) of the ship.

For components that are subject to loads resulting from propeller/ice interaction with all the propeller blades, the number of load cycles ( $N_{ice}$ ) is to be multiplied by the number of propeller blades ( $Z$ ).

**1.4.3 Axial design loads for open and ducted propellers**

a) Maximum ice thrust on propeller  $T_f$  and  $T_b$  for open and ducted propellers.

The maximum forward and backward ice thrusts are:

$$T_f = 1,1 F_f$$

$$T_b = 1,1 F_b$$

b) Design thrust along the propulsion shaft line for open and ducted propellers

The design thrust along the propeller shaft line is to be calculated with the formulae below. The greater value of the forward and backward direction loads shall be taken as the design load for both directions. The factors 2,2 and 1,5 take into account the dynamic magnification resulting from axial vibration.

In a forward direction:  $T_r = T + 2,2 T_f$

In a backward direction:  $T_r = 1,5 T_b$

If the hydrodynamic bollard thrust,  $T$ , is not known,  $T$  is to be taken equal to the values given in Tab 6.

**Figure 2 : Weibull-type distribution (probability that  $F_{ice}$  exceeds  $(F_{ice})_{max}$ ) used for fatigue design**

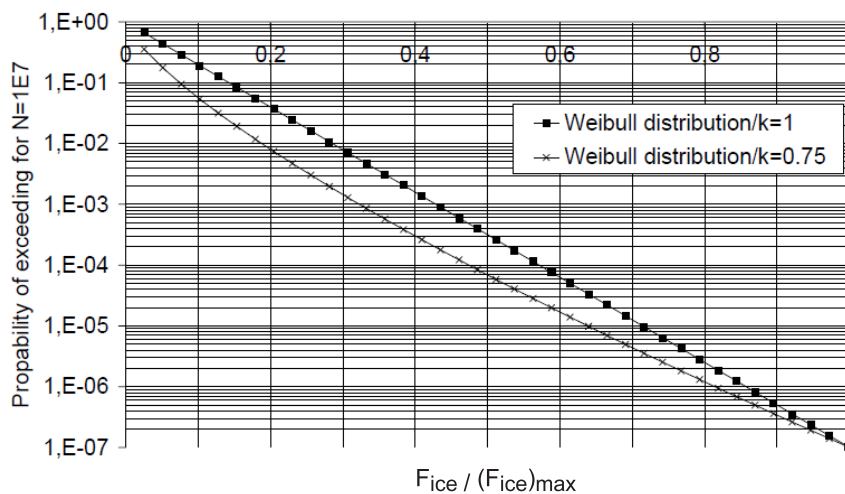
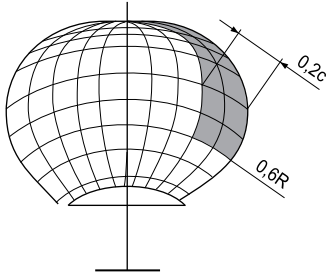
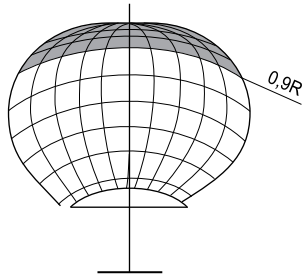
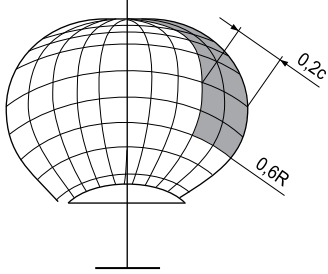
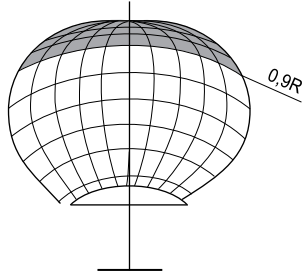
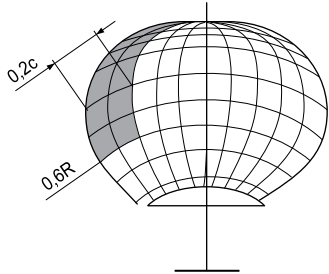
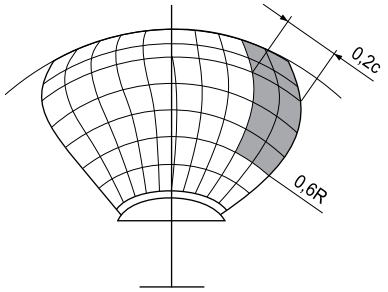
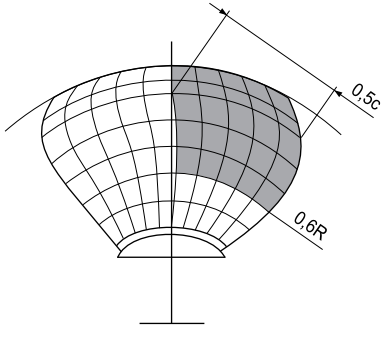
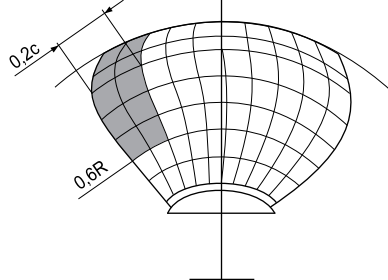


Table 4 : Load cases for open propellers

	Force	Loaded Area	Right-handed propeller blade seen from behind
Load Case 1	$F_b$	Uniform pressure applied on the blade back (suction side) to an area from $0,6R$ to the tip and from the leading edge to $0,2$ times the chord length	
Load Case 2	50% of $F_b$	Uniform pressure applied on the blade back (suction side) of the blade tip area outside $0,9R$ radius	
Load Case 3	$F_f$	Uniform pressure applied on the blade face (pressure side) to an area from $0,6R$ to the tip and from the leading edge to $0,2$ times the chord length	
Load Case 4	50% of $F_f$	Uniform pressure applied on the blade face (pressure side) of the blade tip area outside $0,9R$ radius	
Load Case 5	60% of $F_f$ or 60% of $F_b$ , whichever is greater	Uniform pressure applied on the blade face (pressure side) to an area from $0,6R$ to the tip and from the trailing edge to $0,2$ times the chord length	

**Table 5 : Load cases for ducted propellers**

	Force	Loaded Area	Right-handed propeller blade seen from behind
Load Case 1	$F_b$	Uniform pressure applied on the blade back (suction side) to an area from 0,6R to the tip and from the leading edge to 0,2 times the chord length	
Load Case 3	$F_f$	Uniform pressure applied on the blade face (pressure side) to an area from 0,6R to the tip and from the leading edge to 0,5 times the chord length	
Load Case 5	60% of $F_f$ or 60% of $F_b$ , whichever is greater	Uniform pressure applied on the blade face (pressure side) to an area from 0,6R to the tip and from the trailing edge to 0,2 times the chord length	

**Table 6 : Hydrodynamic bollard thrust T**

Propeller type	T
CP propellers (open)	1,25 $T_n$
CP propellers (ducted)	1,1 $T_n$
FP propellers driven by turbine or electric motor	$T_n$
FP propellers driven by diesel engine (open)	0,85 $T_n$
FP propellers driven by diesel engine (ducted)	0,75 $T_n$

**Table 7 : Rotational propeller speed n, at MCR in bollard condition**

Propeller type	n
CP propellers	$n_n$
FP propellers driven by turbine or electric motor	$n_n$
FP propellers driven by diesel engine	0,85 $n_n$

**1.4.4 Torsional design loads**

a) Design ice torque on propeller  $Q_{max}$  for open propellers:

- when  $D \leq D_{limit}$

$$Q_{max} = 10,9 \left(1 - \frac{d}{D}\right) \left(\frac{P_{0,7}}{D}\right)^{0,16} (nD)^{0,17} D^3$$

- when  $D > D_{limit}$

$$Q_{max} = 20,7 \left(1 - \frac{d}{D}\right) \left(\frac{P_{0,7}}{D}\right)^{0,16} (nD)^{0,17} D^{1,9} H_{ice}^{1,1}$$

where:

$$D_{limit} = 1,8 H_{ice}$$

b) Design ice torque on propeller  $Q_{max}$  for ducted propellers:

- when  $D \leq D_{limit}$

$$Q_{max} = 7,7 \left(1 - \frac{d}{D}\right) \left(\frac{P_{0,7}}{D}\right)^{0,16} (nD)^{0,17} D^3$$

- when  $D > D_{limit}$

$$Q_{max} = 14,6 \left(1 - \frac{d}{D}\right) \left(\frac{P_{0,7}}{D}\right)^{0,16} (nD)^{0,17} D^{1,9} H_{ice}^{1,1}$$

where:

$$D_{limit} = 1,8 H_{ice}$$

c) Design torque for non-resonant shaft line:

When there is not any relevant first blade order torsional resonance in the operational speed range or in range 20% above and 20% below the maximum operating speed (bollard condition), the following estimation of the maximum torque is to be used:



- for directly coupled two stroke diesel engines without flexible coupling:

$$Q_{\text{peak}} = Q_{\text{emax}} + Q_{\text{vib}} + Q_{\text{max}} \frac{I_e}{I_t}$$

- for other plants :

$$Q_{\text{peak}} = Q_{\text{emax}} + Q_{\text{max}} \frac{I_e}{I_t}$$

All the torques and the inertia moments are to be reduced to the rotation speed of the component being examined.

d) Design torque for shaft lines having resonances:

When there is a first blade order torsional resonance in the operational speed range or in the range 20% above and 20% below the maximum operating speed (bollard condition), the design torque ( $Q_{\text{peak}}$ ) of the shaft component is to be determined by means of torsional vibration analysis of the propulsion line. There are two alternative ways of performing the dynamic analysis:

- time domain calculation for estimated milling sequence excitation (see item e)
- frequency domain calculation for blade orders sinusoidal excitation (see item f)

The frequency domain analysis is generally considered conservative compared to the time domain simulation, provided that there is a first blade order resonance in the considered speed range.

e) Time domain calculation of torsional response:

Time domain calculations are to be calculated for the MCR condition, MCR bollard conditions and for blade order resonant rotational speeds so that the resonant vibration responses can be obtained.

The load sequence given in this chapter, for a case where a propeller is milling an ice block, is to be used for the strength evaluation of the propulsion line. The given load sequence is not intended for propulsion system stalling analyses.

The following load cases are intended to reflect the operational loads on the propulsion system, when the propeller interacts with ice, and the respective reaction of the complete system. The ice impact and system response causes loads in the individual shaft line components. The ice torque  $Q_{\text{max}}$  is to be taken as a constant value in the complete speed range. When considerations at specific shaft speeds are performed, a relevant  $Q_{\text{max}}$  is to be calculated using the relevant speed according to item a) or item b).

Diesel engine plants without an elastic coupling are to be calculated at the least favourable phase angle for ice versus engine excitation, when calculated in the time domain. The engine firing pulses is to be included in the calculations and their standard steady state harmonics can be used.

When there is a blade order resonance just above the MCR speed, calculations are to cover rotational speeds up to 105% of the MCR speed.

The propeller ice torque excitation for shaft line transient dynamic analysis in the time domain is defined as a sequence of blade impacts which are of half sine shape.

The excitation frequency shall follow the propeller rotational speed during the ice interaction sequence. The torque due to a single blade ice impact as a function of the propeller rotation angle is then defined using the formula:

- when  $\varphi = 0, \dots, \alpha_i$  plus integer revolutions:

$$Q(\varphi) = C_q Q_{\text{max}} \sin [\varphi (180/\alpha_i)]$$

- when  $\varphi = \alpha_i, \dots, 360^\circ$  plus integer revolutions:

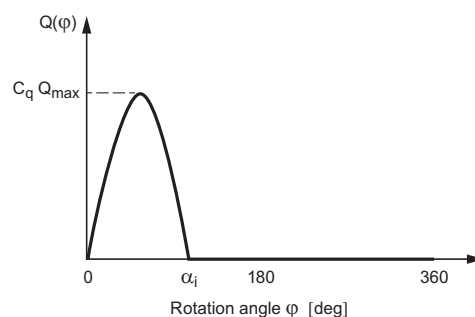
$$Q(\varphi) = 0$$

where:

$\alpha_i$  : Duration of propeller blade/ice interaction given in Tab 8 and represented in Fig 3.

$C_q$  : Ice impact magnification parameter given in Tab 8.

**Figure 3 : Schematic ice torque due to a single blade ice impact**



The total ice torque is obtained by summing the torque of single blades, while taking into account of the phase shift  $360^\circ/Z$  (see Fig 4 and Fig 5). At the beginning and end of the milling sequence (within the calculated duration) linear ramp functions are to be used to increase  $C_q$  to its maximum value within one propeller revolution and vice versa to decrease it to zero (see examples of different  $Z$  numbers in Fig 4 and Fig 5).

The number of propeller revolutions during a milling sequence are to be obtained with the formula:

$$N_Q = 2 H_{\text{ice}}$$

The number of impacts is  $Z \cdot N_Q$  for blade order excitation.

A dynamic simulation is to be performed for all excitation cases at the operational rotational speed range. For a fixed pitch propeller propulsion plant, a dynamic simulation must also cover the bollard pull condition with a corresponding rotational speed assuming the maximum possible output of the engine.

When a speed drop occurs until the main engine is at a standstill, this indicates that the engine may not be sufficiently powered for the intended service task. For the consideration of loads, the maximum occurring torque during the speed drop process must be used.

For the time domain calculation, the simulated response torque typically includes the engine mean torque and the propeller mean torque. When this is not the case, the response torques must be obtained using the formula:

$$Q_{\text{peak}} = Q_{\text{emax}} + Q_{\text{rtid}}$$

where  $Q_{\text{rtid}}$  is the maximum simulated torque obtained from the time domain analysis.

f) Frequency domain calculation of torsional response:  
 For frequency domain calculations, blade order and twice-the-blade-order excitation are to be used. The amplitudes for the blade order and twice-the-blade-order sinusoidal excitation have been derived based on the assumption that the time domain half sine impact sequences were continuous, and the Fourier series components for blade order and twice-the-blade-order components have been derived. With these assumptions, the propeller ice torque  $Q_f(\varphi)$ , in kN·m, is equal to:

$$Q_{\max} [C_{q0} + C_{q1} \sin(Z E_0 \varphi + \alpha_1) + C_{q2} \sin(2Z E_0 \varphi + \alpha_2)]$$

where:

- $C_{q0}$  : Mean torque parameter, see Tab 9
- $C_{q1}$  : First blade order excitation parameter, see Tab 9
- $C_{q2}$  : Second blade order excitation parameter, see Tab 9
- $E_0$  : Number of ice blocks in contact, see Tab 9.

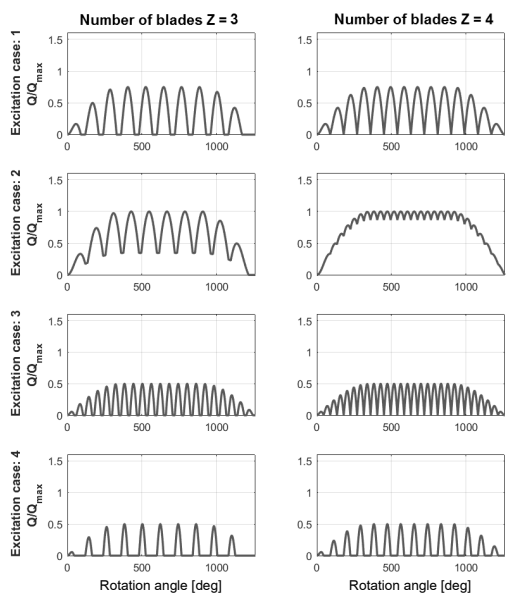
The design torque for the frequency domain excitation case is to be obtained using the formula:

$$Q_{\text{peak}} = Q_{\text{emax}} + Q_{\text{vib}} + (Q_{\max} C_{q0}) \frac{1}{I_1} + Q_{\text{rf1}} + Q_{\text{rf2}}$$

where:

- $C_{\text{rf1}}$  : First blade order torsional response from the frequency domain analysis
- $C_{\text{rf2}}$  : Second blade order torsional response from the frequency domain analysis.

**Figure 4 : Propeller ice torque excitation for 3 and 4 blades**



**Table 8 : Parameters  $C_q$  and  $\alpha_i$**

Torque excitation	Propeller/ice interaction	$C_q$	$\alpha_i$			
			Z = 3	Z = 4	Z = 5	Z = 6
Case 1	Single ice block	0,75	90	90	72	60
Case 2	Single ice block	1,0	135	135	135	135
Case 3	Two ice blocks (phase shift 360/2Z deg.)	0,5	45	45	36	30
Case 4	Single ice block	0,5	45	45	36	30

All the torque values have to be scaled to the shaft revolutions for the component in question.

g) Guidance for torsional vibration calculation:

The aim of time domain torsional vibration simulations is to estimate the extreme torsional load during the ship's service life. The simulation model can be taken from the normal lumped mass elastic torsional vibration model, including damping.

For a time domain analysis, the model should include the ice excitation at the propeller, other relevant excitations and the mean torques provided by the prime mover and hydrodynamic mean torque in the propeller.

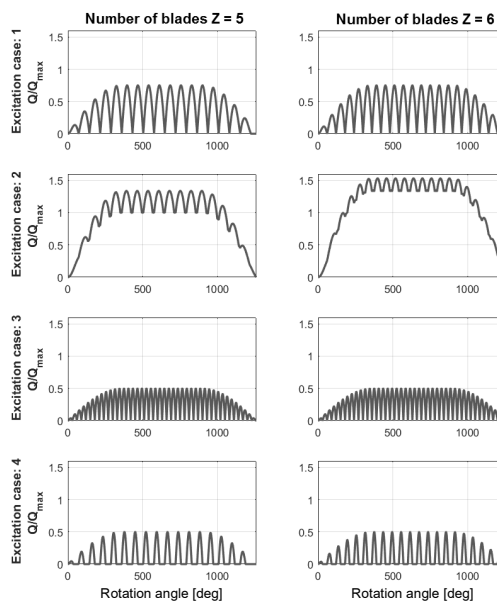
The calculations should cover variation of phase between the ice excitation and prime mover excitation.

This is extremely relevant to propulsion lines with directly driven combustion engines. Time domain calculations shall be calculated for the MCR condition, MCR bollard conditions and for resonant speed, so that the resonant vibration responses can be obtained.

For frequency domain calculations, the load should be estimated as a Fourier component analysis of the continuous sequence of half sine load sequences. First and second order blade components should be used for excitation.

The calculation should cover the entire relevant rpm range and the simulation of responses at torsional vibration resonances.

**Figure 5 : Propeller ice torque excitation for 5 and 6 blades**



**Table 9 : Coefficients for frequency domain excitation calculation (Z)**

	Torque excitation	$C_{q0}$	$C_{q1}$	$\alpha_1$	$C_{q2}$	$\alpha_2$	$E_0$
Z = 3	Case 1	0,375	0,36	-90	0	0	1
	Case 2	0,7	0,33	-90	0,05	-45	1
	Case 3	0,25	0,25	-90	0	0	2
	Case 4	0,2	0,25	0	0,05	-90	1
Z = 4	Case 1	0,45	0,36	-90	0,06	-90	1
	Case 2	0,9375	0	-90	0,0625	-90	1
	Case 3	0,25	0,25	-90	0	0	2
	Case 4	0,2	0,25	0	0,05	-90	1
Z = 5	Case 1	0,45	0,36	-90	0,06	-90	1
	Case 2	1,19	0,17	-90	0,02	-90	1
	Case 3	0,3	0,25	-90	0,048	-90	2
	Case 4	0,2	0,25	0	0,05	-90	1
Z = 6	Case 1	0,45	0,36	-90	0,05	-90	1
	Case 2	1,435	0,1	-90	0	0	1
	Case 3	0,30	0,25	-90	0,048	-90	2
	Case 4	0,2	0,25	0	0,05	-90	1

**Table 10 : Default prime mover maximum torque  $Q_{emax}$** 

Propeller type	$Q_{emax}$
Propellers driven by electric motor	$Q_{motor}$
CP propellers not driven by electric motor	$Q_n$
FP propellers driven by turbine	$Q_n$
FP propellers driven by diesel engine	$0,75 Q_n$

**1.4.5 Blade failure load**a) Bending force,  $F_{ex}$ 

The ultimate load resulting from blade failure as a result of plastic bending around the blade root is to be calculated with the formula as follows:

$$F_{ex} = \frac{300ct^2\sigma_{ref1}}{0,8D - 2r}$$

where:

$c, t, r$  : Actual chord length, maximum thickness and radius, respectively, of the cylindrical root section of the blade which is the weakest section outside the root fillet typically located at the point where the fillet terminates at the blade profile.

The ultimate load may be obtained alternatively by means of an appropriate stress analysis reflecting the non-linear plastic material behaviour of the actual blade. In such a case, the blade failure area may be outside the root section. The ultimate load is assumed to be acting on the blade at the 0,8R radius in the weakest direction of the blade. A blade is regarded as having failed if the tip is bent into an offset position by more than 10% of propeller diameter D.

b) Spindle torque,  $Q_{sex}$ 

The maximum spindle torque due to a blade failure load acting at 0,8R is to be determined. The force that causes blade failure typically reduces when moving from the propeller centre towards the leading and trailing edges. At a certain distance from the blade centre of rotation, the maximum spindle torque will occur ( Fig 6 illustrates the spindle torque values due to blade failure loads across the entire chord length). This maximum spindle torque shall be defined by an appropriate stress analysis or using the equation given below:

$$Q_{sex} = C_{LTx} C_{spex} F_{ex}$$

where:

$C_{LTx}$  : Coefficient to be taken equal to:

$$Q_{LTx} = \max(C_{LE0.8}; 0,8C_{TE0.8})$$

$C_{spex}$  : Coefficient to be taken equal to:

$$C_{spex} = C_{sp} C_{fex} = 0,7 \left( 1 - \left( \frac{4EAR}{Z} \right)^3 \right)$$

without being taken less than 0,3

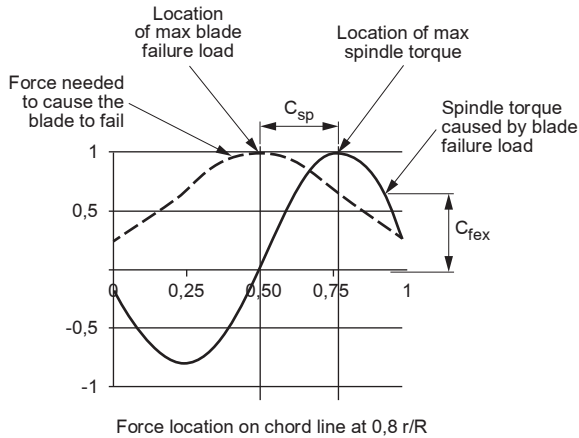
$C_{sp}$  : Parameter taking account of the spindle arm

$C_{fex}$  : Parameter taking account of the reduction of the blade failure force at the location of the maximum spindle torque

$C_{LE0.8}$  : Leading edge portion of the chord length at 0,8R

$C_{TE0.8}$  : Trailing edge portion of the chord length at 0,8R

**Figure 6 : Blade failure load and related spindle torque along chord line at radius 0,8R**



## 1.5 Propeller blade design

### 1.5.1 Calculation of blade stresses

The blade stresses are to be calculated for the design loads given in [1.4.2]. Finite element analysis is to be used for stress analysis for final approval for all propellers. The following simplified formulae can be used in estimating the blade stresses for all propellers at the root area ( $r/R < 0,5$ ).

The root area dimensions based on the following formula can be accepted even if the FEM analysis shows greater stresses at the root area:

$$\sigma_{st} = C_1 \frac{M_{BL}}{100ct^2}$$

where:

$C_1$  : Constant equal to:

$$C_1 = \frac{\text{actual stress}}{\text{stress obtained with beam equation}}$$

If the actual value is not available,  $C_1$  is to be taken as 1,6.

$M_{BL}$  : For relative radius  $r/R < 0,5$ :

$$M_{BL} = (0,75 - r/R) R \cdot F$$

where F is the maximum of  $F_b$  and  $F_f$ , which ever has greater absolute value.

### 1.5.2 Acceptability criterion

The following criterion for calculated blade stresses is to be fulfilled:

$$\frac{\sigma_{ref2}}{\sigma_{st}} \geq 1,3$$

where:

$\sigma_{st}$  : Calculated stress for the design loads.

If FEM analysis is used in estimating the stresses, von Mises stresses are to be used.

### 1.5.3 Fatigue design of propeller blade

The fatigue design of the propeller blade is based on an estimated load distribution during the service life of the ship and on the S-N curve for the blade material. An equivalent stress that produces the same fatigue damage as the expected load distribution is to be calculated and the acceptability criterion for fatigue is to be fulfilled as given in [1.5.4]. The equivalent stress is normalised for  $10^8$  cycles.

For materials with a two-slope SN curve (see Fig 7), fatigue calculations in accordance with this chapter are not required if the following criterion is fulfilled:

$$\sigma_{exp} \geq B_1 \cdot \sigma_{ref2}^{B_2} \cdot \log(N_{ice})^{B_3}$$

where:

$B_1, B_2, B_3$  : Coefficients for open and ducted propellers:

- for open propellers:
  - $B_1 = 0,00246$
  - $B_2 = 0,947$
  - $B_3 = 2,101$
- for ducted propellers:
  - $B_1 = 0,00167$
  - $B_2 = 0,956$
  - $B_3 = 2,470$

For calculation of equivalent stress, two types of S-N curves are available:

- two-slope S-N curve (slopes 4,5 and 10), see Fig 7
- constant-slope S-N curve (the slope can be chosen), see Fig 8.

The type of the S-N curve is to be selected to correspond to the material properties of the blade. If the S-N curve is not known, the two-slope S-N curve is to be used.

a) Equivalent fatigue stress

The equivalent fatigue stress  $\sigma_{fat}$  for  $10^8$  stress cycles, which produces the same fatigue damage as the load distribution, is given by the following formula:

$$\sigma_{fat} = \rho (\sigma_{ice})_{max}$$

where:

$(\sigma_{ice})_{max}$  : Mean value of the principal stress amplitudes resulting from design forward and backward blade forces at the location being studied and defined by:

$$(\sigma_{ice})_{max} = 0,5 [(\sigma_{ice})_{f max} + (\sigma_{ice})_{b max}]$$

$(\sigma_{ice})_{f max}$  : Principal stress resulting from forward load

$(\sigma_{ice})_{b max}$  : Principal stress resulting from backward load.

In calculation of  $(\sigma_{ice})_{max}$ , case 1 and case 3 (or case 2 and case 4) are considered as a pair for  $(\sigma_{ice})_{f max}$  and  $(\sigma_{ice})_{b max}$  calculations. Case 5 is excluded from the fatigue analysis.

b) Calculation of parameter  $\rho$  for two-slope S-N curve

The parameter  $\rho$  relates the maximum ice load to the distribution of ice loads according to the regression formula:

$$\rho = C_1 \cdot (\sigma_{ice})_{max}^{C_2} \cdot \sigma_{fl}^{C_3} \cdot \log(N_{ice})^{C_4}$$

where:

$C_1, C_2, C_3, C_4$ : Coefficients given in Tab 11

$$\sigma_{fl} = \gamma_{e1} \cdot \gamma_{e2} \cdot \gamma_v \cdot \gamma_m \cdot \sigma_{exp}$$

with:

$\gamma_v$  : Reduction factor for variable amplitude loading

$\gamma_m$  : Reduction factor for mean stress.

The following values may be used for the reduction factors if the actual values are not available:

$$\gamma_{e1} \cdot \gamma_{e2} = 0,67$$

$$\gamma_v = 0,75$$

$$\gamma_m = 0,75$$

c) Calculation of parameter  $\rho$  for constant-slope S-N curve

For materials with a constant-slope S-N curve (see Fig 8), parameter  $\rho$  is to be calculated from the following formula:

$$\rho = \left( G \frac{N_{ice}}{N_R} \right)^{\frac{1}{m}} [\ln(N_{ice})]^{-\frac{1}{k}}$$

where:

$k$  : Shape parameter of the Weibull distribution:

- for ducted propellers:  $k = 1,0$
- for open propellers:  $k = 0,75$

$N_{ice}$  : Value to be taken between  $5 \cdot 10^6$  and  $10^8$

$G$  : Parameter defined in Tab 12. Linear interpolation may be used to calculate the value of  $G$  for other  $m/k$  ratios than those given in Tab 12.

### 1.5.4 Acceptability criterion for fatigue

The equivalent fatigue stress at all locations on the blade is to fulfill the following acceptability criterion:

$$\frac{\sigma_{fl}}{\sigma_{fat}} \geq 1,5$$

where:

$\sigma_{fl}$  : As defined in [1.5.3], item b).

Figure 7 : Two-slope S-N curve

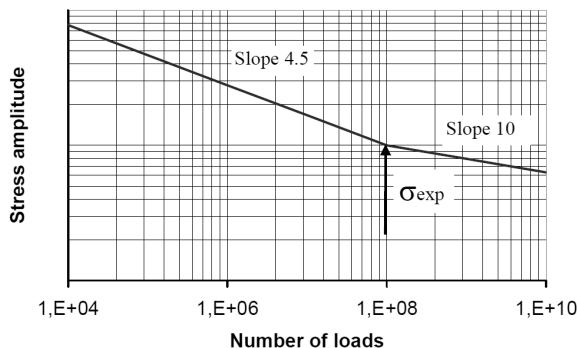


Figure 8 : Constant-slope S-N curve

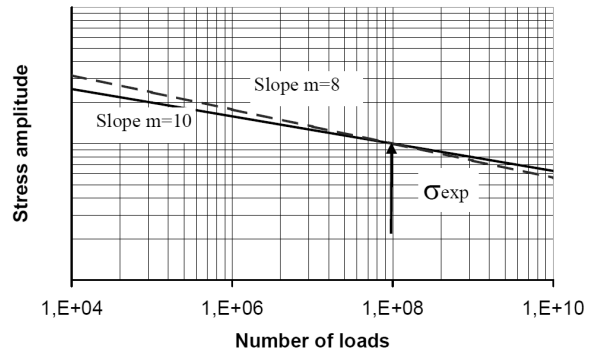


Table 11 : Coefficients  $C_1, C_2, C_3$  and  $C_4$

	Open propeller	Ducted propeller
$C_1$	0,000747	0,000534
$C_2$	0,0645	0,0533
$C_3$	-0,0565	-0,0459
$C_4$	2,22	2,584

Table 12 : Values for the  $G$  parameter for different  $m/k$  ratios

$m/k$	$G$	$m/k$	$G$	$m/k$	$G$
3,0	6,0	6,0	720,0	9,0	362880
3,5	11,6	6,5	1871	9,5	$1,133 \cdot 10^6$
4,0	24,0	7,0	5040	10	$3,626 \cdot 10^6$
4,5	52,3	7,5	14034	10,5	$11,899 \cdot 10^6$
5,0	120	8,0	40320	11	$39,917 \cdot 10^6$
5,5	287,9	8,5	119292	11,5	$136,843 \cdot 10^6$
				12	$479,002 \cdot 10^6$

## 1.6 Controllable pitch propeller

### 1.6.1 Spindle torque due to blade failure

Spindle torque  $Q_{spex}$  around the spindle axis of the blade fitting is to be calculated for the load case described in [1.4.5] for  $F_{ex}$ .

$Q_{spex}$ , in kN·m, is to be such that:

$$Q_{spex} \geq \frac{2}{3} L_{ex} \cdot F_{ex}$$

where:

$L_{ex}$  : Maximum distance, in m, from the spindle axis to the leading or trailing edge, whichever is greater, at 0,8R radius.

The spindle arm may be reduced to  $1/3 L_{ex}$ , provided plastic FEM analysis is performed to evaluate the blade failure loads and the corresponding spindle torque values.

### 1.6.2 Design of blade flange and bolts, propeller hub and controllable pitch mechanism

The blade bolts, the controllable pitch mechanism, the propeller boss and the fitting of the propeller to the propeller shaft are to be designed to withstand the design loads defined in [1.4]. The safety factor against yielding is to be greater than 1,3 and the safety factor against fatigue greater than 1,5. In addition, the safety factor against yielding for loads resulting from loss of the propeller blade through plastic bending as defined in [1.4.5] is to be greater than 1,0.

### 1.6.3 Blade bolts and flanges

Blade bolts and flanges are to withstand the bending moment  $M_{\text{bolt}}$ , in kN·m, considered about the bolt pitch circle axis, or another relevant axis for not circular flanges, parallel to the considered root section:

$$M_{\text{bolt}} = F_{\text{ex}} \left( 0,8 \frac{D}{2} - r_{\text{bolt}} \right)$$

where:

$r_{\text{bolt}}$  : Radius from the shaft centreline to the blade bolt plan, in m.

Blade bolt pre-tension is to be sufficient to avoid separation between the mating surfaces, applying the maximum forward and backward ice loads defined in [1.4.2].

The maximum stresses of blade flange, crank carrier and hub due to the load induced by  $M_{\text{bolt}}$  are to remain below the corresponding yield strengths.

Separate means, e.g. dowel pins, are to be provided in order to withstand a spindle torque resulting from blade failure ( $Q_{\text{spex}}$ ) or ice interaction ( $Q_{\text{smax}}$ ), whichever is greater.

The rule diameter  $d_{\text{dp}}$  of the dowel pins, in m, is given by the following formula:

$$d_{\text{dp}} = 10^3 \sqrt[3]{\frac{8\sqrt{3}Q_s}{\text{PCD} \cdot i \cdot \pi \cdot R_e}}$$

where:

PCD : Pitch circle diameter of the dowel pins, in mm

$i$  : Number of pins

$Q_s$  : Spindle torque, in kN·m, equal to:

$$Q_s = \max(1,3 Q_{\text{smax}}; Q_{\text{spex}}) - Q_{\text{frR}} - Q_{\text{fr2}}$$

with:

$Q_{\text{frR}}$  : Friction torque in blade bearing, in kN·m, caused by the reaction forces due to  $F_{\text{ex}}$

$Q_{\text{fr2}}$  : Friction torque between connected surfaces resulting from blade bolt pretension forces, in kN·m.

Friction coefficient of 0,15 is to be applied for calculation of  $Q_{\text{frR}}$  and  $Q_{\text{fr2}}$ , unless otherwise justified.

### 1.6.4 Components of the pitch control system

Components of controllable pitch mechanisms are to be designed to withstand the blade failure spindle torque  $Q_{\text{spex}}$  and the maximum blade spindle torque  $Q_{\text{smax}}$ .

The blade failure spindle torque  $Q_{\text{spex}}$  is not to lead to any consequential damages.

Fatigue strength is to be considered for the parts transmitting the spindle torque  $Q_s$  from the blades to a servo system, considering  $Q_s$  acting on one blade.

The maximum spindle torque amplitude  $Q_{\text{samax}}$  is defined by:

$$Q_{\text{samax}} = \frac{Q_{\text{sb}} + Q_{\text{sf}}}{2}$$

where:

$Q_{\text{sb}}, Q_{\text{sf}}$  : Spindle torques due, respectively, to ice backward and forward forces.

The formula given in [1.4.2] item g) may be used to determine  $Q_{\text{sb}}$  and  $Q_{\text{sf}}$ .

### 1.6.5 Servo oil pressure

Design pressure for servo oil system is to be taken as the maximum working pressure, taking into account the load caused by  $Q_{\text{smax}}$  or  $Q_{\text{spex}}$  when not protected by relief valves, reduced by relevant friction losses in bearings caused by the respective ice loads. Design pressure is, in any case, not to be less than the relief valve set pressure.

## 1.7 Propulsion line design

### 1.7.1 Design principle

The strength of the propulsion line is to be designed according to the pyramid strength principle. This means that the loss of the propeller blade is not to cause any significant damage to other propeller shaft line components.

The shafts and shafting components, such as the thrust and stem tube bearings, couplings, flanges and sealings, are to be designed to withstand the propeller/ice interaction loads as given in [1.4]. The safety factor is to be at least 1,3 against yielding for extreme operational loads, 1,5 for fatigue loads and 1,0 against yielding for the blade failure load.

The ultimate load resulting from total blade failure as defined in [1.4.5] is not to cause yielding in shafts and shaft components. The loading is to consist of the combined axial, bending, and torsion loads, wherever this is significant. The minimum safety factor against yielding is to be 1,0 for bending and torsional stresses.

### 1.7.2 Materials

In addition to the requirements of [1.3.1], the shaft material is to comply with Pt C, Ch 1, Sec 7, [2.1.2].

### 1.7.3 Scantling of propeller, intermediate and thrust shafts

The minimum rule diameter  $d_{\text{ice}}$ , in mm, of propeller, intermediate and thrust shafts with ice strengthening is equal to:

$$d_{\text{ice}} = d \cdot K_{\text{ice-s}}^{\frac{1}{3}}$$

where:

$$K_{\text{ice-s}} = Q_r / Q_n \geq 1$$

$d$  : Rule shaft diameter, defined in Pt C, Ch 1, Sec 7, [2.2.3].

### 1.7.4 Scantling of gear shaft

This requirement applies to parts of pinions and wheel shafts between bearings. The other parts of the gear shaft may be considered as intermediate shaft parts.

The minimum rule diameter  $d_{ice}$ , in mm, of gear shaft with ice strengthening is equal to:

$$d_{ice} = d \cdot K_{ice-s}^{\frac{1}{3}}$$

where:

$$K_{ice-s} = Q_r / Q_n \geq 1$$

$d$  : Rule shaft diameter, defined in Pt C, Ch 1, Sec 6, [4.4.2].

### 1.7.5 Calculation of propeller blade failure

The calculation of load due to blade failure is to take into account compression, flexion and torque on shaft induced by the force  $F_{ex}$ . The corresponding calculated von Mises stress is to remain below the shaft material yield strength.

The propeller shaft diameter in way of the aft stern tube bearing is to be at least equal to the minimum rule diameter  $d_{ice}$  calculated according to [1.7.3], without being less than the rule diameter  $d_{ex}$  given by the following formula:

$$d_{ex} = 160 \left[ \frac{F_{ex} D}{R_e (1 - Q^4)} \right]^{\frac{1}{3}}$$

where:

$R_e$  : Yield strength of propeller shaft material, in MPa

$Q$  : Factor equal to  $d_i / d_o$ , as defined in Pt C, Ch 1, Sec 7, [2.2.3].

Forward of the aft stern tube bearing, the propeller shaft diameter may be reduced based on direct calculation of the actual bending moments or on the assumption that the bending moment caused by  $F_{ex}$  is linearly reduced to 50% at the next bearing, down to zero at the third bearing.

The shaft diameter of the corresponding section is, in any case, not to be less than the minimum rule diameter  $d_{ice}$  calculated according to [1.7.3].

### 1.7.6 Alternative design procedure

Alternative calculation methods to determine design loads of the propulsion components may be considered by the Society. Any alternative calculation method is to include all the relevant loads on the complete dynamic shafting system under all permissible operating conditions. The peak operating torque is therefore to be calculated by means of torsional vibration analysis of the propulsion line, including ice loads and main engine excitations in accordance with the requirements of [1.4.4].

Moreover, an alternative calculation method is to take into account continuous and transient operating loads (dimensioning for fatigue strength) and peak operating loads (dimensioning for yield strength). The ratio of yield strength with respect to corresponding maximum stress is to be at least 1,3 in plain shaft section and 1,0 in stress concentrations sections. The fatigue strength is to be determined with consideration of the dimensions and arrangements of all the shaft connections, and the safety factor is to be at least 1,5.

## 1.8 Coupling

### 1.8.1 Flange couplings

The dimensions of coupling flanges are to comply with the requirements of Pt C, Ch 1, Sec 7, [2.5.1].

When the bolts are not fitted, the minimum transmitted torque is equal to the nominal torque  $Q_n$  multiplied by the flange coupling ice factor  $K_{ice-cp}$  given by:

$$K_{ice-cp} = \frac{Q_{peak}}{Q_n} \geq 1$$

where:

$Q_{peak}$  : Maximum peak torque, in kN·m, to be determined from the results of torsional vibration analysis due to ice impact.

As an alternative, the following estimation may be used:

- for main propulsion systems powered by diesel engines fitted with slip type or high elasticity couplings, by turbines or by electric motors:

$$Q_{peak} = Q_{emax} + Q_{max} \cdot I / I_t$$

- for main propulsion systems powered by diesel engines fitted with couplings other than those mentioned above:

$$Q_{peak} = 1,2 Q_{emax} + Q_{max} \cdot I / I_t$$

In case of fitted bolts, the requirements of Pt C, Ch 1, Sec 7, [2.5.1] apply, using the rule shaft diameter defined in [1.7.3].

The safety factors to be applied are indicated in Pt C, Ch 1, Sec 7, [2.5.1]. With respect to torque transmission, a reduced safety factor of 1,3 may be applied, provided that  $1,3 Q_{peak} > 2,5 Q_n$ .

Moreover, the bolts are to be designed so that the blade failure load in forward or backward directions does not cause yielding.

### 1.8.2 Shrunk couplings

Non-integral couplings which are shrunk on the shaft by means of the oil pressure injection method or by other means may be accepted, provided that the design complies with Pt C, Ch 1, Sec 7, [2.5.2]. The minimum transmitted torque is the nominal torque multiplied by the ice factor  $K_{ice-cp}$  defined in [1.8.1].

The safety factors to be applied are indicated in Pt C, Ch 1, Sec 7, [2.5.2]. With respect to torque transmission, a reduced safety factor of 1,3 may be applied, provided that  $1,3 Q_{peak} > 2,5 Q_n$ .

### 1.8.3 Keyed couplings

Keyed couplings are, in general, not to be used in installations with ice class notation.

Keyed couplings may be accepted, provided that the principal mean of torque transmission is ensured by friction in accordance with [1.8.2]. Moreover, the keyway is to comply with the requirements of Pt C, Ch 1, Sec 7, [2.5.5].

### 1.8.4 Flexible couplings

The flexible couplings are to comply with Pt C, Ch 1, Sec 7, [2.5.4]. In addition, the stiff parts of flexible couplings subjected to torque are to be designed to withstand the loads defined in [1.4.4], item d).

The maximum peak torque  $Q_{\text{peak}}$  in the flexible components is not to exceed the relevant limits specified by the manufacturer. This is to be verified with a torsional vibration analysis of the propulsion line, including ice loads in accordance with the requirements of [1.4.4].

### 1.8.5 Clutches

Clutches are to have a static friction torque of at least 1,3 times the peak torque  $Q_{\text{peak}}$  and a dynamic friction torque of at least 2/3 of the static friction torque.

Emergency operation of clutch after failure of, e.g., operating pressure is to be made possible within a reasonably short time. When arranged with bolts, the coupling is to be on the engine side of the clutch in order to ensure access to any bolt by turning the engine.

## 1.9 Gear

### 1.9.1 General

The load capacity of gearings is to comply with the requirements of Pt C, Ch 1, Sec 6, provided that the parameters defined in [1.9.2] to [1.9.4] are used in the detailed method.

### 1.9.2 Application factor

For the calculation of gearing including ice requirements, the application factor  $K_A$  defined in Pt C, Ch 1, Sec 6, Tab 5 is to be replaced by the application factor  $K_{A\text{-ice}}$  equal to:

$$K_{A\text{-ice}} = K_A + \frac{Q_{\text{eq}} \cdot I}{Q_n}$$

with:

$Q_{\text{eq}}$  : Equivalent ice torque calculated in accordance with ISO 6336 Pt.6 A.3.

The following load spectrum is to be applied to the definition of the ice torque on the propeller  $Q_{\text{max}}$ , in accordance with the Weibull distribution:

$$Q_{\text{ice}}(N) = Q_{\text{max}} \left[ 1 - \frac{\log N}{\log(ZN_{\text{ice}})} \right]$$

where:

$N$  : Number of cycles

$Q_{\text{max}}$  : Maximum ice torque on the propeller, as defined in [1.4.4]

$N_{\text{ice}}$  : Number of ice cycles, as defined in [1.4.2].

The load spectrum is to be divided into 10 load blocks minimum and the effective number of cycles for each load block is calculated with the following formula:

$$n_i = (ZN_{\text{ice}})^{\frac{i}{i_{\text{max}}}} - \sum_{j=2}^i n_{j-1}$$

where:

$i$  : Index of each load block (starting at 1 for the highest load value)

$n_i$  : Number of cycles for the load  $Q_i$  defined by:

$$Q_i = Q_{\text{max}} [1 - (i - 1) / i_{\text{max}}]$$

with:

$i_{\text{max}}$  : Total number of blocks, taken not less than 10.

### 1.9.3 Inertia ratio

The inertia ratio to be used is  $I / I_t$ .

Engine inertia is not to be neglected unless the peak torque  $Q_{\text{peak}}$  is calculated from the torsional vibration analysis as defined in [1.4.4].

### 1.9.4 Safety factors

The safety factors  $S_H$  and  $S_F$  to be applied are those indicated in Pt C, Ch 1, Sec 6, [2.4.14] and Pt C, Ch 1, Sec 6, [2.5.15].

## 1.10 Chockfast calculation

**1.10.1** The calculation of gearbox chockfast is to be carried out taking into consideration the load due to the transmitted torque and using the application factor  $K_{A\text{-Ice}}$ .

## 1.11 Azimuthing main propulsors

### 1.11.1 Design principles

In addition to the above requirements for propeller blade dimensioning, azimuthing thrusters have to be designed for thruster body/ice interaction loads.

Load formulae are given for estimating once in a lifetime extreme loads on the thruster body, based on the estimated ice condition and ship operational parameters. Two main ice load scenarios have been selected for defining the extreme ice loads. Examples of loads are illustrated in Fig 9. In addition, blade order thruster body vibration responses may be estimated for propeller excitation. The following load scenario types are considered:

- Ice block impact to the thruster body or propeller hub
- Thruster penetration into an ice ridge that has a thick consolidated layer
- Vibratory response of the thruster at blade order frequency.

The steering mechanism, the fitting of the unit, and the body of the thruster are to be designed to withstand the plastic bending of a blade without damage. The loss of a blade must be taken into account for the propeller blade orientation causing the maximum load on the component being studied. Top-down blade orientation typically places the maximum bending loads on the thruster body.



Figure 9 : Examples of load scenario types

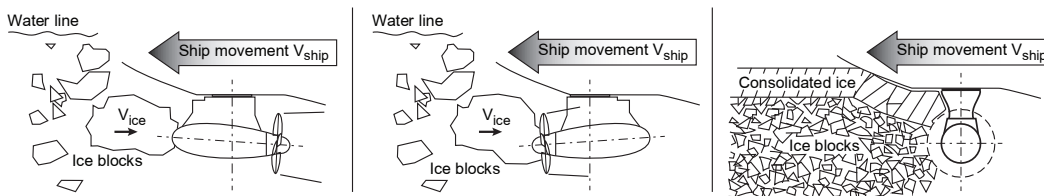
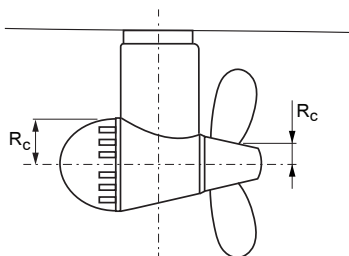


Figure 10 : Dimensions used for Rc



1.11.2 Extreme ice impact loads

When the ship is operated in ice conditions, ice blocks formed in channel side walls or from the ridge consolidated layer may impact on the thruster body and also on the propeller hub. Exposure to ice impact is very much dependent on the ship size and ship hull design, as well as location of the thruster. The contact force will grow in terms of thruster/ice contact until the ice block reaches the ship speed.

The thruster has to withstand the loads occurring when the design ice block defined in Tab 2 impacts on the thruster body when the ship is sailing at a typical ice operating speed. Load cases for impact loads are given in Tab 13. The contact geometry is estimated to be hemispherical in shape. If the actual contact geometry differs from the shape of the hemisphere, a sphere radius has to be estimated so that the growth of the contact area as a function of penetration of ice corresponds as closely as possible to the actual geometrical shape penetration.

The ice impact contact load  $F_{ti}$ , in kN, is to be calculated as follows:

$$F_{ti} = C_{DMI} 34.5 R_C^{0.5} (m_{ice} v_s^2)^{0.333}$$

where:

- $R_C$  : Impacting part sphere radius, in m, as shown in Fig 10
- $m_{ice}$  : Ice block mass, in kg, as given in Tab 14
- $C_{DMI}$  : Dynamic magnification factor for impact loads. If unknown,  $C_{DMI}$  may to be taken from Tab 14
- $v_s$  : Impact speed, in m/s, as defined in Tab 15 or Tab 16. On a case by case basis,  $v_s$  can also be derived from the ship actual design operation speed in ice, subject to the Society agreement.

For impacts on non-hemispherical areas, such as the impact on the nozzle,  $R_C$  is to be replaced by the equivalent impact sphere radius  $R_{ceq}$  in m, to be estimated using the equation below:

$$R_{ceq} = \sqrt{\frac{A}{\pi}}$$

where:

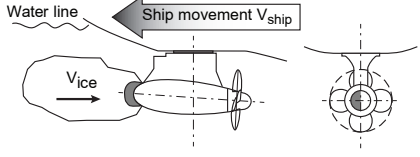
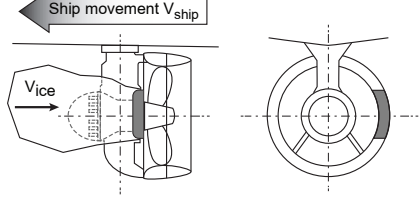
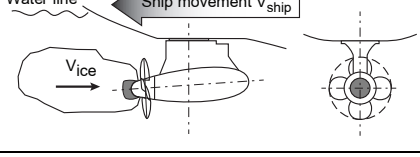
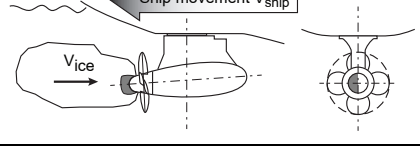
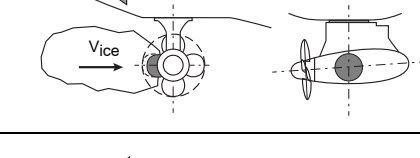
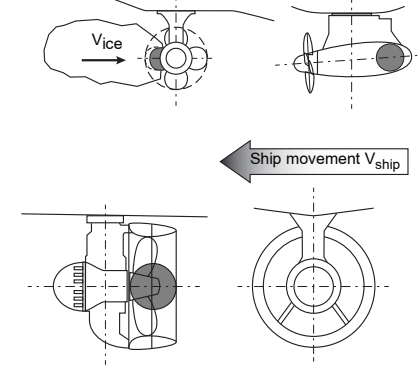
- $A$  : Contact area, in  $m^2$ , as shown in Tab 13.
- If the  $2 \cdot R_{ceq}$  is greater than the ice block thickness given in Tab 14, the radius is set to half of the ice block thickness.

For impact on the thruster side, the pod body diameter can be used as basis for determining the radius. For impact on the propeller hub, the hub diameter can be used as basis for the radius.

Note 1: The longitudinal impact speed in Tab 15 and Tab 16 refers to the impact in the thruster's main operational direction. For the pulling propeller configuration, the longitudinal impact speed is used for load case T2, impact on hub; and for the pushing propeller unit, the longitudinal impact speed is used for load case T1, impact on thruster end cap. For the opposite direction, the impact speed for transversal impact is applied.

Table 13 : Load cases for azimuthing thruster impact loads

Load Case	Force		Loaded area
Load case T1a Symmetric longitudinal ice impact on thruster	$F_{ti}$	Uniform pressure applied symmetrically on the impact area	

Load Case	Force	Loaded area
Load case T1b Non-symmetric longitudinal ice impact on thruster	50% of $F_{ti}$	Uniform pressure applied on the other half of the impact area 
Load case T1c Non-symmetric longitudinal ice impact on nozzle	$F_{ti}$	Uniform pressure applied on the impact area. Contact area is equal to the nozzle thickness ( $H_{nz}$ )* contact height ( $H_{ice}$ ) 
Load case T2a Symmetric longitudinal ice impact on propeller hub	$F_{ti}$	Uniform pressure applied symmetrically on the impact area 
Load case T2b Non-symmetric longitudinal ice impact on propeller hub	50% of $F_{ti}$	Uniform pressure applied on the other half of the impact area 
Load case T3a Symmetric lateral ice impact on thruster body	$F_{ti}$	Uniform pressure applied symmetrically on the impact area 
Load case T3b Non-symmetric lateral ice impact on thruster body or nozzle	$F_{ti}$	Uniform pressure applied on the other half of the impact area. Nozzle contact radius R to be taken from the nozzle length 

**Note 1:** For fixed thrusters, only the relevant load cases are to be considered.

**Table 14 : Parameter values for ice dimensions and dynamic magnification**

Notation	IA Super	IA	IB	IC
Thickness of the design ice block impacting thruster (2/3 of $H_{ice}$ ) (m)	1,17	1,0	0,8	0,67
Extreme ice block mass ( $m_{ice}$ ) (kg)	8760	5460	2800	1600
$C_{DMI}$ (if not known)	1,3	1,2	1,1	1,0

**Table 15 : Impact speeds  $v_s$  for aft centerline thruster (m/s)**

Notations	IA Super	IA	IB	IC
Longitudinal impact in main operational direction	6	5	5	5
Longitudinal impact in reversing direction (pulling unit propeller hub or pushing unit cover end cap impact)	4	3	3	3
Transversal impact in bow first operation	3	2	2	2
Transversal impact in stern first operation (double acting ship)	4	3	3	3

**Table 16 : Impact speeds  $v_s$  for aft, wing, bow centerline and bow wing thrusters (m/s)**

Notations	IA Super	IA	IB	IC
Longitudinal impact in main operational direction	6	5	5	5
Longitudinal impact in reversing direction (pulling unit propeller hub or pushing unit cover end cap impact)	4	3	3	3
Transversal impact	4	3	3	3

### 1.11.3 Extreme ice loads on thruster hull when penetrating an ice ridge

In icy conditions, ships typically operate in ice channels. When passing other ships, ships may be subject to loads caused by their thrusters penetrating ice channel walls. There is usually a consolidated layer at the ice surface, below which the ice blocks are loose. In addition, the thruster may penetrate ice ridges when backing. Such a situation is likely in the case of ships having a notation **ICE CLASS IA SUPER** in particular, because they may sail independently in difficult ice conditions. However, the thrusters in ships with lower ice classes may also have to withstand such a situation, but at a remarkably lower ship speed.

In this load scenario, the ship is penetrating a ridge in thruster first mode with an initial speed. This situation occurs when a ship with a thruster at the bow moves forward, or a ship with a thruster astern moves in backing mode. The maximum load during such an event is considered the extreme load. An event of this kind typically lasts several seconds, due to which the dynamic magnification is considered negligible and is not taken into account.

The ridge penetration load  $F_{tr}$ , in kN, is to be calculated for the load cases shown in Tab 17, using the formula below:

$$F_{tr} = 32v_s^{0.66}H_r^{0.9}A_t^{0.74}$$

where:

- $v_s$  : Ridge penetration speed, in m/s, as given in Tab 18 and Tab 19. On a case by case basis,  $v_s$  can also be derived from the ship actual design operation speed in ice, subject to the Society agreement, in m/s
- $H_r$  : Total thickness of the design ridge, in m, as given in Tab 18 and Tab 19
- $A_t$  : Projected area of the thruster, in  $m^2$ , as shown in Tab 17. When calculating the contact area for

thruster-ridge interaction, the loaded area in vertical direction is limited to the ice ridge thickness as shown in Fig 11.

The loads must be applied as uniform pressure over the thruster surface.

### 1.11.4 Acceptability criterion for static loads

The stresses on the thruster have to be calculated for the extreme once in a lifetime loads described in [1.11.1]. The nominal von Mises stresses on the thruster body must have a safety margin of 1,3 against yielding strength of the material. At areas of local stress concentrations, stresses must have a safety margin of 1,0 against yielding.

The slewing bearing, bolt connections and other components must be able to maintain operability without incurring damage that requires repair when subject to loads given in [1.11.2] and [1.11.3] multiplied by safety factor 1,3.

### 1.11.5 Thruster body global vibration

Evaluating the global vibratory behaviour of the thruster body is important, if the first blade order excitations are in the same frequency range with the thruster global modes of vibration, and which occur when the propeller rotational speeds are in the high power range of the propulsion line. This evaluation is mandatory and it must be shown that there is either no global first blade order resonance at high operational propeller speeds (above 50% of maximum power) or that the structure is designed to withstand vibratory loads during resonance above 50% of maximum power.

When estimating thruster global natural frequencies in the longitudinal and transverse direction, the damping and added mass due to water must be taken into account. In addition to this, the effect of ship attachment stiffness is to be modeled.

Figure 11 : Schematic figure showing the reduction of the contact area by the maximum ridge thickness

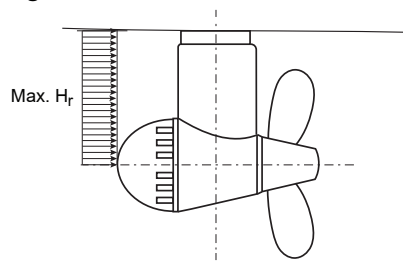


Table 17 : Load cases for ridge ice loads

Load Case	Force		Loaded area
Load case T4a Symmetric longitudinal ridge penetration loads	$F_{tr}$	Uniform pressure applied symmetrically on the impact area	
Load case T4b Non-symmetric longitudinal ridge penetration loads	50% of $F_{tr}$	Uniform pressure applied on the other half of the contact area	
Load case T5a Symmetric lateral ridge penetration loads for ducted azimuthing unit and pushing open propeller unit	$F_{tr}$	Uniform pressure applied symmetrically on the contact area	

Load Case	Force	Loaded area	
Load case T5b Non-symmetric lateral ridge penetration loads for all azimuthing units	50% of $F_{tr}$	Uniform pressure applied on the other half of the contact area	
<b>Note 1:</b> For fixed thrusters, only the relevant load cases are to be considered.			

**Table 18 : Parameters for calculating maximum loads when thruster penetrates an ice ridge  
Aft thrusters, bow first operation**

Notations		IA Super	IA	IB	IC
Total thickness of the design ridge ( $H_r$ ) (m)		8	8	6,5	5
Initial ridge penetration speed ( $v_s$ ) (m/s)	Longitudinal loads	4	2	2	2
	Transversal loads	2	1	1	1

**Table 19 : Parameters for calculating maximum loads when thruster penetrates an ice ridge  
Thruster first mode such as double acting ships**

Notations		IA Super	IA	IB	IC
Total thickness of the design ridge ( $H_r$ ) (m)		8	8	6,5	5
Initial ridge penetration speed ( $v_s$ )(m/s)	Longitudinal loads	6	4	4	4
	Transversal loads	3	2	2	2

## 2 Requirements for propulsion machinery of ICE CLASS ID

### 2.1 Ice torque

**2.1.1** For the scantlings of propellers and shafting, the effect of the impact of the propeller blades against ice is also to be taken into account.

The ensuing torque, hereafter defined as ice torque, is to be taken equal to the value  $M_G$ , in N m, calculated by the following formula:

$$M_G = m D^2$$

where:

$m$  : Coefficient equal to 10000

$D$  : Propeller diameter, in m.

### 2.2 Propellers

#### 2.2.1 Material

The percentage elongation after fracture, measured with a proportional type tensile specimen, of materials used for propellers is to be not less than 15%. Materials other than copper alloys are to be Charpy V-notch impact tested at a temperature of  $-10^\circ\text{C}$  with a minimum average energy not less than 20 J.

#### 2.2.2 Scantlings

When the notation **ICE CLASS ID** is requested, the width  $\ell$  and the maximum thickness  $t$  of the cylindrical sections of the propeller blades are to be such as to satisfy the conditions stated in items a), b) and c) below.

a) Cylindrical sections at the radius of 0,125 D, for fixed pitch propellers:

$$\ell \cdot t^2 \geq \frac{26,5}{R_m \cdot \left[ 0,65 + \left( \frac{0,7}{\rho} \right) \right]} \cdot \left( \frac{2,85 M_T}{z} + 2,24 M_G \right)$$

- b) Cylindrical sections at the radius of 0,175 D, for controllable pitch propellers:

$$\ell \cdot t^2 \geq \frac{21,1}{R_m \cdot \left[0,65 + \left(\frac{0,7}{\rho}\right)\right]} \cdot \left(\frac{2,85M_T}{z} + 2,35M_G\right)$$

- c) Cylindrical sections at the radius of 0,3 D, for both fixed and controllable pitch propellers:

$$\ell \cdot t^2 \geq \frac{9,3}{R_m \cdot \left[0,65 + \left(\frac{0,7}{\rho}\right)\right]} \cdot \left(\frac{2,85M_T}{z} + 2,83M_G\right)$$

where:

- $\ell$  : Width of the expanded cylindrical section of the blade at the radius in question, in cm
- $t$  : Corresponding maximum blade thickness, in cm
- $\rho$  : D/H
- D : Propeller diameter, in m
- H : Blade pitch of propeller, in m, to be taken equal to:
- the pitch at the radius considered, for fixed pitch propellers
  - 70% of the nominal pitch, for controllable pitch propellers
- P : Maximum continuous power of propulsion machinery for which the classification has been requested, in kW
- n : Speed of rotation of propeller, in rev/min, corresponding to the power P
- $M_T$  : Value, in N·m, of torque corresponding to the above power P and speed n, calculated as follows:
- $$M_T = 9550 \cdot \frac{P}{n}$$
- z : Number of propeller blades
- $M_G$  : Value of the ice torque, in N·m, calculated according to the formula given in [2.1.1].
- $R_m$  : Value, in N/mm<sup>2</sup>, of the minimum tensile strength of the blade material.

### 2.2.3 Minimum thickness of blades

When the blade thicknesses, calculated by the formulae given in Pt C, Ch 1, Sec 8, [2.2.1] and Pt C, Ch 1, Sec 8, [2.3.1], are higher than those calculated on the basis of the formulae given in [2.2.2], the higher values are to be taken as rule blade thickness.

### 2.2.4 Minimum thickness at top of blade

The maximum thickness of the cylindrical blade section at the radius 0,475 D is not to be less than the value  $t_1$ , in mm, obtained by the following formula:

$$t_1 = (15 + 2D) \cdot \left(\frac{490}{R_m}\right)^{0,5}$$

In the formulae above, D and  $R_m$  have the same meaning as specified in [2.2.2].

### 2.2.5 Blade thickness at intermediate sections

The thickness of the other sections of the blade is to be determined by means of a smooth curve connecting the points defined by the blade thicknesses calculated by the formulae given in [2.2.2] and [2.2.4].

### 2.2.6 Thickness of blade edge

The thickness of the whole blade edge, measured at a distance from the edge itself equal to 1,25  $t_1$  ( $t_1$  being the blade thickness as calculated by the appropriate formula given in [2.2.4]), is to be not less than 0,5  $t_1$ .

For controllable pitch propellers, this requirement is applicable to the leading edge only.

### 2.2.7 Controllable pitch propeller actuating mechanism

The strength of the blade-actuating mechanism located inside the controllable pitch propeller hub is to be not less than 1,5 times that of the blade when a force is applied at the radius 0,45 D in the weakest direction of the blade.

## 2.3 Shafting

### 2.3.1 Propeller shafts

- a) The diameter of the propeller shaft at its aft bearing is not to be less than the value  $d_p$ , in mm, calculated by the following formula:

$$d_p = K_E \cdot \left(\frac{W \cdot R_m}{R_{S,MIN}}\right)^{\frac{1}{3}}$$

where:

- $K_E$  : •  $K_E = 10,8$  for propellers having hub diameter not greater than 0,25 D  
•  $K_E = 11,5$  for propellers having hub diameter greater than 0,25 D
- W : Value, in cm<sup>3</sup>, equal to  $\ell \cdot t^2$ , proposed for the section at the radius:
- 0,125 D for propellers having the hub diameter not greater than 0,25 D
  - 0,175 D for propellers having the hub diameter greater than 0,25 D
- $R_m$  : Value, in N/mm<sup>2</sup>, of the minimum tensile strength of the blade material
- $R_{S,MIN}$  : Value, in N/mm<sup>2</sup>, of the minimum yield strength ( $R_{eH}$ ) or 0,2% proof stress ( $R_{p0,2}$ ) of the propeller shaft material.
- b) Where the diameter of the propeller shaft, as calculated by the formula given in Pt C, Ch 1, Sec 7, [2.4], is greater than that calculated according to the formula given in a) above, the former value is to be adopted.
- c) Where a cone-shaped length is provided in the propeller shaft, it is to be designed and arranged in accordance with the applicable requirements of Pt C, Ch 1, Sec 7.
- d) Propeller shafts are to be of steel having impact strength as specified in NR216 Materials and Welding.

### 3 Miscellaneous requirements

#### 3.1 Starting arrangements

**3.1.1** The capacity of the air receivers is to be sufficient to provide without reloading not less than 12 consecutive starts of the propulsion engine, if this one is to be reversed for going astern, or 6 consecutive starts if the propulsion engine is not to be reversed for going astern.

If the air receivers serve any other purposes than starting the propulsion engine, they are to have additional capacity sufficient for these purposes.

The capacity of the air compressors is to be sufficient for charging the air receivers from atmospheric to full pressure in one hour, except for a ship having the notation **ICE CLASS IA SUPER** and its propulsion engine reserved for going astern, in which case the compressor is to be able to charge the receivers in half an hour.

#### 3.2 Sea inlets, ballast systems and cooling water systems of machinery

##### 3.2.1

- a) The cooling water system is to be designed to secure the supply of cooling water also when navigating in ice.
- b) For this purpose, for ships with the notations **ICE CLASS IA SUPER**, **ICE CLASS IA**, **ICE CLASS IB**, **ICE CLASS IC** or **ICE CLASS ID**, at least one sea water inlet chest is to be arranged and constructed as indicated hereafter:
  - 1) The sea inlet is to be situated near the centreline of the ship and as aft as possible.
  - 2) As guidance for design, the volume of the chest is to be around one cubic metre for every 750 kW of the aggregate output of the engines installed on board, for both main propulsion and essential auxiliary services.
  - 3) The chest is to be sufficiently high to allow ice to accumulate above the inlet pipe.
  - 4) A pipe for discharging the cooling water, having the same diameter as the main overboard discharge line, is to be connected to the inlet chest.
  - 5) The area of the strum holes is to be not less than 4 times the inlet pipe sectional area.
- c) Where there are difficulties in satisfying the requirements of items b) 2) and b) 3) above, alternatively two smaller chests may be accepted, provided that they are located and arranged as stated in the other provisions above.
- d) Heating coils may be installed in the upper part of the chests.
- e) Arrangements for using ballast water for cooling purposes may be accepted as a reserve in terms of ballast but are not acceptable as a substitute for the sea inlet chests as described above.
- f) Where required by Ch 8, Sec 1, [2.2.2], the ballast tanks are to be provided with suitable devices to prevent the water from freezing, which shall be so designed as to avoid any ice formation in the tank which may be detrimental to the tank. For that purpose, the following may be accepted:
  - heating systems by heating coils within ballast tanks
  - internal circulating/pumping systems
  - bubbling systems
  - steam injection systems.

Where bubbling systems are applied, following shall be complied with:

- sufficient number of air nozzles is to be distributed along the shell side bottom
  - the maximum air pressure induced in the tank is not to exceed the design pressure of tank structure
  - exposed vent pipe and vent heads shall be protected from possible blocking by ice
  - if the bubbling systems is not supplied by a dedicated compressed air plant, the general service air system may be used for that purpose if justified that its capacity takes into account the air consumption of the bubbling system.
- g) Where ballast water exchange at sea is accepted as a process for the treatment of ballast water, ship side ballast discharge valves are to be protected from freezing in accordance with Pt C, Ch 1, Sec 10, [7.3.3], item d). Suitable protection shall be provided also for ballast tanks vent heads, as well as for ballast overflows where existing.

#### 3.3 Steering gear

##### 3.3.1

- a) In the case of ships with the notations **ICE CLASS IA SUPER** or **ICE CLASS IA**, due regard is to be paid to the excessive loads caused by the rudder being forced out of the centreline position when backing into an ice ridge.
- b) Effective relief valves are to be provided to protect the steering gear against hydraulic overpressure.
- c) The scantlings of steering gear components are to be such as to withstand the yield torque of the rudder stock.
- d) Where possible, rudder stoppers working on the blade or rudder head are to be fitted.

#### 3.4 Fire pumps

**3.4.1** The suction of at least one fire pump is to be connected to a sea inlet protected against icing.

#### 3.5 Transverse thrusters

**3.5.1** Tunnels of transverse thrusters are to be fitted with grids for protection against ice impacts.

#### 3.6 Test and certification for propellers

**3.6.1** Requirements mentioned in Pt C, Ch 1, Sec 8, [4] are to be referred to. Additionally, material tests mentioned in [1.3] and [2.2.1] are to be undertaken.





Part F  
**Additional Class Notations**

Chapter 9

**POLLUTION PREVENTION (CLEANSHIP)**

---

- SECTION 1      GENERAL REQUIREMENTS**
- SECTION 2      DESIGN REQUIREMENTS FOR THE NOTATIONS CLEANSHIP  
AND CLEANSHIP SUPER**
- SECTION 3      DESIGN REQUIREMENTS FOR THE POLLUTION PREVENTION  
NOTATIONS OTHER THAN CLEANSHIP AND CLEANSHIP  
SUPER**
- SECTION 4      ONBOARD SURVEYS**



# SECTION 1

# GENERAL REQUIREMENTS

## 1 Scope and application

### 1.1 General

1.1.1 This Chapter contains the requirements for the prevention of sea and air pollution.

1.1.2 Additional class notations for the prevention of sea and air pollution include:

- **CLEANSHIP** and **CLEANSHIP SUPER** notations,
- other notations having a specific scope.

For the assignment of the **CLEANSHIP SUPER** notation, at least three notations among those referred to as “eligible” in Tab 1, column 4, are also to be assigned.

**Table 1 : Additional class notations for the prevention of pollution**

Symbol	Scope	Reference to the Rules	Eligible for the assignment of <b>CLEANSHIP SUPER</b> notation	Assignment conditions
<b>CLEANSHIP</b>	Prevention of sea and air pollution	Ch 9, Sec 2, [2]	N/A	
<b>CLEANSHIP SUPER</b>	Prevention of sea and air pollution	Ch 9, Sec 2, [2] Ch 9, Sec 2, [3]	N/A	At least 3 eligible notations are to be assigned
<b>AWT-A or AWT-B or AWT-A/B</b>	Fitting of an advanced wastewater treatment plant	Ch 9, Sec 3, [2]	Yes	
<b>BWE</b>	The ship is designed for Ballast Water Exchange in accordance with the technical provisions of BWM Convention (2004), Regulation D-1	Ch 9, Sec 3, [3]	No	
<b>BWT</b>	Fitting of a Ballast Water Treatment plant	Ch 9, Sec 3, [4] and NI538	Yes	
<b>CEMS</b>	Fitting of an emission monitoring system	Ch 9, Sec 3, [11]	No	
<b>EGCS-SCRUBBER</b>	The ship is fitted with an exhaust gas cleaning system using scrubber(s)	Ch 9, Sec 3, [10]	Yes	
<b>GREEN PASSPORT</b>	Hazardous material inventory	NR528	No	
<b>GWT</b>	Fitting of a treatment installation for Grey Waters	Ch 9, Sec 3, [5]	Yes	
<b>HVSC</b>	Fitting of a High Voltage Shore Connection	NR557	Yes	Alternatively, use of natural gas as fuel when the ship is at berth may be accepted, provided that the provisions of NR529 are complied with
<b>NDO-x days</b>	The ship is designed for No Discharge Operation during x days	Ch 9, Sec 3, [6]	Yes	
<b>NOX-x%</b>	Average NOx emissions of engines not exceeding x% of IMO Tier II limit	Ch 9, Sec 3, [7]	Yes	
<b>OWS-x ppm</b>	Fitting of an Oily Water Separator producing effluents having a hydrocarbon content not exceeding x ppm (parts per million)	Ch 9, Sec 3, [8]	Yes	
<b>SOX-x%</b>	Oil fuels used within and outside SECAs have a sulphur content not exceeding x% of the relevant IMO limit	Ch 9, Sec 3, [9]	Yes	As an alternative, equivalent arrangements (e.g. exhaust gas cleaning systems) may be accepted
<b>VCS</b>	The ship is fitted with a Vapour Control System	Pt E, Ch 10, Sec 7	No	Applies only to tankers

**Note 1:** N/A = not applicable.

The relevant symbol, scope, reference to the Rules and assignment conditions are given in Tab 1.

Examples of notations are given below:

- **CLEANSHIP**
- **CLEANSHIP, BWE**
- **CLEANSHIP SUPER (AWT-A, NOX-80%, SOX-60%)**
- **OWS-5 ppm**
- **AWT-A/B, NDO-2 days**

## 1.2 Applicable rules and regulations

**1.2.1** It is a prerequisite for the assignment of any additional class notation listed in Tab 1 that the ship complies with the following regulations:

- a) adopted Annexes of the MARPOL 73/78 Convention
- b) International Convention on the control of harmful anti-fouling systems, 2001.

**1.2.2** Additional requirements may be imposed by the ship flag Authorities and/or by the State or Port Administration in the jurisdiction of which the ship is intended to operate, in particular with respect to:

- exhaust gas smoke (particulate emissions, smoke opacity)
- fuel oil sulphur content
- bilge water oil content
- on board waste incineration.

## 2 Definitions and abbreviations

### 2.1 Definitions related to sea pollution

#### 2.1.1 Hazardous wastes

Hazardous wastes are those wastes composed of substances which are identified as marine pollutants in the International Maritime Dangerous Goods Code (IMDG Code).

Hazardous wastes include in particular:

- photo processing chemicals
- dry cleaning waste
- used paints
- solvents
- heavy metals
- expired chemicals and pharmaceuticals
- waste from printers
- hydrocarbons and chlorinated hydrocarbons
- used fluorescent and mercury vapour light bulbs
- batteries.

Note 1: Empty packagings previously used for the carriage of hazardous substances are to be considered as hazardous substances.

#### 2.1.2 Wastewater

Wastewater includes both sewage and grey water defined hereunder.

#### 2.1.3 Sewage

Sewage means:

- drainage and other wastes from any form of toilets, urinals, and WC scuppers, here designated as black waters

- drainage from medical premises (dispensary, sick bay, etc.) via wash basins, wash tubs and scuppers located in such premises
- drainage from spaces containing live animals, or
- other waste waters when mixed with the drainages defined above.

#### 2.1.4 Sewage sludge

Sewage sludge means any solid, semi-solid, or liquid residue removed during the treatment of on-board sewage.

#### 2.1.5 Grey water

Grey water includes drainage from dishwashers, showers, sinks, baths and washbasins, laundry and galleys.

#### 2.1.6 Garbage

Garbage means all kinds of victual, domestic and operational waste excluding fresh fish and parts thereof, generated during the normal operation of the ship and liable to be disposed of continuously or periodically, except those substances which are defined or listed in Annexes I, II, III and IV to MARPOL 73/78.

Garbage includes all kinds of solid wastes like plastics, paper, oily rags, glass, metal, bottles, and incinerator ash. Food wastes are considered as garbage.

#### 2.1.7 Oil residue (sludge)

Oil residue (sludge) means the residual waste oil products generated during the normal operation of a ship such as those resulting from the purification of fuel or lubricating oil for main or auxiliary machinery, separated waste oil from oil filtering equipment, waste oil collected in drip trays, and waste hydraulic and lubricating oils.

#### 2.1.8 Oil residue (sludge) tank

Oil residue (sludge) tank means a tank which holds oil residue (sludge) from which sludge may be disposed directly through the standard discharge connection or any other approved means of disposal.

#### 2.1.9 Oily bilge water

Oily bilge water means water which may be contaminated by oil resulting from things such as leakage or maintenance work in machinery spaces. Any liquid entering the bilge system including bilge wells, bilge piping, tank top or bilge holding tanks is considered oily bilge water.

#### 2.1.10 Oily bilge water holding tank

Oily bilge water holding tank means a tank collecting oily bilge water prior to its discharge, transfer or disposal.

#### 2.1.11 Oily wastes

Oily wastes means oil residues (sludge) and oily bilge water.

#### 2.1.12 Advanced Wastewater Treatment (AWT)

Any treatment of wastewater that goes beyond the secondary or biological water treatment stage and may include the removal of nutrients such as phosphorus and nitrogen and a high percentage of suspended solids. AWT water effluent standard corresponds to the technology currently available for municipal wastewater treatment plants.

AWT plants are to be of a type approved in accordance with IMO resolution MEPC(227)64.

### 2.1.13 Accidental discharge

All discharge to sea caused by unforeseen or accidental events, such as damage to the ship or its equipment, and including discharge necessary for the purpose of protection of the ship or saving life at sea.

### 2.1.14 No discharge condition

Condition without discharge of hazardous wastes, treated and untreated wastewater, oily wastes or garbage into the sea.

Note 1: Where the **AWT-A/B** notation is assigned to the ship, the discharge of treated sewage and treated grey water is allowed.

Note 2: In the "No discharge condition", no effluents from exhaust gas cleaning systems may be discharged into the sea.

## 2.2 Definitions related to air pollution

### 2.2.1 Emission

Emission means any release of substances, subject to control by Annex VI of MARPOL 73/78, from ships into the atmosphere or sea.

### 2.2.2 Ozone depleting substances

Ozone-depleting substances means controlled substances defined in paragraph (4) of article 1 of the Montreal Protocol on Substances that Deplete the Ozone Layer, 1987, listed in Annexes A, B, C or E to the said protocol in force at the time of application or interpretation of Annex VI of MARPOL 73/78.

Ozone-depleting substances that may be found on board ship include, but are not limited to:

- Halon 1211 Bromochlorodifluoromethane
- Halon 1301 Bromotrifluoromethane
- Halon 2402 1,2-Dibromo-1,1,2,2-tetrafluoroethane (also known as Halon 114B2)
- CFC-11 Trichlorofluoromethane
- CFC-12 Dichlorodifluoromethane
- CFC-113 Trichloro-1,2,2-trifluoroethane
- CFC-114 1,2-Dichloro-1,1,2,2-tetrafluoroethane
- CFC-115 Chloropentafluoroethane.

### 2.2.3 NO<sub>x</sub> technical code

NO<sub>x</sub> Technical Code means the Revised Technical Code on Control of Emission of Nitrogen Oxides from Marine Diesel Engines adopted at MEPC 58 on 10 October 2008 with Resolution MEPC.177(58).

### 2.2.4 Emission control area

Emission control area means an area where the adoption of special mandatory measures for emissions from ships is

required to prevent, reduce and control air pollution from NO<sub>x</sub> or SO<sub>x</sub> and particulate matter or all three types of emissions and their attendant adverse impacts on human health and the environment. Emission control areas include those listed in, or designated under, regulations 13 and 14 of Annex VI of MARPOL 73/78.

### 2.2.5 Shipboard incineration

Shipboard incineration means the incineration of wastes or other matter on board a ship, if such wastes or other matter were generated during normal operation of that ship.

### 2.2.6 Shipboard incinerator

Shipboard incinerator means a shipboard facility designed for the primary purpose of incineration.

## 2.3 Abbreviations

### 2.3.1 AWT

AWT means advanced wastewater treatment.

### 2.3.2 ECA

ECA means emission control area.

### 2.3.3 EGC

EGC means exhaust gas cleaning.

### 2.3.4 OWS

OWS means oily water separator.

## 3 Documents to be submitted and applicable standards

### 3.1 Documents to be submitted

#### 3.1.1 Certificates

The certificates to be submitted prior to the delivery of the additional class notations **CLEANSHIP**, **CLEANSHIP SUPER** and other notations are listed in Tab 2.

#### 3.1.2 Operational procedures

The operational procedures to be submitted are listed in Tab 3.

#### 3.1.3 Plans and documents

The plans and documents to be submitted are listed in Tab 4.

### 3.2 Modifications and additions

**3.2.1** In case of modifications or additions to the approved installations, arrangements or procedures, the relevant details are to be submitted for review.

Table 2 : Required certificates

Notations	Certificate	Applicable Rules and Regulations
<b>CLEANSHIP</b> <b>CLEANSHIP SUPER</b>	IOPP certificate (1)	Annex I of MARPOL 73/78, Appendix II
	Type approval certificate of: • 15 ppm bilge separator • 15 ppm bilge alarm	IMO Resolution MEPC.107(49): • Part 1 of the Annex • Part 2 of the Annex
	ISPP certificate (1)	Annex IV of MARPOL 73/78, Appendix
	Type approval certificate of the sewage system	IMO Resolution MEPC.227(64) as amended by IMO Resolution MEPC.284(70)
	Type approval certificate of the incinerator (2)	• IMO Resolution MEPC.244(66) • Annex VI of MARPOL 73/78, Appendix IV
	IAPP certificate (1)	• Annex VI of MARPOL 73/78, Appendix I • IMO Resolution MEPC.194(61)
	EIAPP certificates of diesel engines (3) (4)	NOx Technical Code 2008, Appendix I
	SOx emission compliance certificate Certificate of unit approval for exhaust gas cleaning system (5)	IMO Resolution MEPC.259(68)
	IAFS certificate or Declaration on Anti-fouling system	International Convention on the control of Harmful and Anti-fouling systems, 2001, Annex 4, Appendices 1 and 2
<b>AWT-A or AWT-B or AWT-A/B</b>	Type approval certificate according to Annex IV of MARPOL 73/78	IMO Resolution MEPC.227(64)
	Type approval certificate of the AWT plant	Ch 9, Sec 3, [2]
<b>BWE</b>	N/R	
<b>BWT</b>	Type approval certificate of the ballast water management system (BWMS)	MEPC.279(70) (or MEPC.174(58) for the BWMS approved before 28/10/2018 and installed before 28/10/2020)
		MEPC.169(57), if the BWMS makes use of active substances
<b>CEMS</b>	Type approval certificate of the measurement, monitoring and recording equipment	• IMO Resolution MEPC.103(49) for NOx emissions • IMO Resolution MEPC.259(68) for SO <sub>2</sub> and CO <sub>2</sub> emissions
<b>EGCS-SCRUBBER</b>	SOx Emission Compliance Certificate (SECC, issued only for units approved on scheme A)	IMO Resolution MEPC.259(68)
<b>GREEN PASSPORT</b>	See NR528	
<b>GWT</b>	Type approval certificate of the grey water treatment plant	Ch 9, Sec 3, [5]
<b>HVSC</b>	See NR557	
<b>NDO-x days</b>	N/R	
<b>NOX-x%</b>	EIAPP certificates of diesel engines (4)	Ch 9, Sec 3, [7]
<b>OWS-x ppm</b>	Type approval certificate of the oily water separator with indication of "x ppm" performance	Ch 9, Sec 3, [8]
<b>SOX-x%</b>	Type approval certificate of the exhaust gas cleaning system (5)	Ch 9, Sec 3, [9]
<b>VCS</b>	Certificate (or statement of compliance) of the vapour emission control system	IMO Circular MSC/Circ.585
<p>(1) Only where required by MARPOL 73/78 Convention, according to the ship's gross tonnage.</p> <p>(2) Shipboard incinerator is not required. However, when fitted on board, it is to be type-approved.</p> <p>(3) Only where required by Annex VI of MARPOL 73/78 Convention, according to the engine power and intended use.</p> <p>(4) The EIAPP certificate may include a NOx-reducing device as a component of the engine. See NOx Technical Code 2008, regulation 2.2.5.</p> <p>(5) Where such an equivalent arrangement is provided in pursuance of Annex VI of MARPOL 73/78 Convention, regulation 4.</p> <p><b>Note 1:</b> N/R = not required</p>		

Table 3 : Required operational procedures

Notations	Operational procedure	Applicable Rules and Regulations
<b>CLEANSHIP CLEANSHIP SUPER</b>	Shipboard oil pollution emergency plan <b>(1)</b>	IMO Resolution MEPC.54(32) as amended by Resolution MEPC.86(44)
	Procedure to prepare and maintain an oil record book <b>(1)</b>	Annex I of MARPOL 73/78, Appendix III
	Procedure to maintain, operate and troubleshoot bilge water treatment systems	IMO Circular MEPC.1/Circ.677
	Bunkering procedure	–
	Measures to prevent oil pollution	–
	Sewage and grey water management plan and discharge control plan <b>(1)</b>	IMO Resolution MEPC.157(55)
	Garbage management plan including procedures to prepare and maintain a garbage record book and hazardous waste procedures <b>(1)</b>	<ul style="list-style-type: none"> <li>• IMO Resolution MEPC.70(38)</li> <li>• IMO Circular MEPC/Circ.317</li> <li>• Annex V of MARPOL 73/78, Appendix</li> <li>• IMO Resolution MEPC.92(45)</li> </ul>
	Operating procedure to be followed to minimise the risk and the consequences of ozone-depleting refrigerant leakage, under normal and emergency conditions, including: <ul style="list-style-type: none"> <li>• checking of the piping tightness</li> <li>• recharge</li> <li>• detection of leakage</li> <li>• maintenance and repair</li> </ul> <b>(2)</b>	–
	Procedure to prepare and maintain the ozone-depleting substances record book	–
	NOx emission control plan	–
	Fuel oil quality management plan	<ul style="list-style-type: none"> <li>• Annex VI of MARPOL 73/78, Regulation 18 and Appendix VI</li> <li>• IMO Resolution MEPC.182(59)</li> </ul>
Where an exhaust gas cleaning (EGC) system is used: <ul style="list-style-type: none"> <li>• SOx emission compliance plan</li> <li>• Onboard monitoring manual</li> <li>• Procedure to prepare and maintain the EGC record book</li> </ul>	IMO Resolution MEPC.259(68)	
<b>AWT-A or AWT-B or AWT-A/B</b>	Wastewater management plan and discharge control plan	–
<b>BWE</b>	Ballast water management plan, with procedures to prepare and maintain a Ballast Water Record Book	IMO Resolution MEPC.127(53)
<b>BWT</b>	As above for <b>BWE</b> notation	<ul style="list-style-type: none"> <li>• IMO Resolution MEPC.127(53)</li> <li>• IMO Circular BWM.2/Circ.20</li> </ul>
	Detailed procedures and information for safe application of active substances	
<b>EGCS-SCRUBBER</b>	<ul style="list-style-type: none"> <li>• Exhaust gas cleaning unit Technical Manual (ETM) for unit</li> <li>• Onboard Monitoring Manual (OMM)</li> <li>• EGC record book or Electronic Logging system</li> <li>• SOx Emission Compliance Plan (for ship, SECP)</li> </ul>	IMO resolution MEPC.259(68)
<b>GREEN PASSPORT</b>	See NR528	
<b>GWT</b>	Grey water management plan and discharge control plan	–
<b>HVSC</b>	See NR557	
<b>NDO-x days</b>	Management and storage plan for liquid effluents and solid waste in case of no-discharge operation	–
<b>NOX-x%</b>	NOx emissions control plan	–
<b>OWS-x ppm</b>	Performance monitoring plan for the oily water separator	–
<b>SOX-x%</b>	SOx emissions control plan	–
<b>VCS</b>	VOC management plan	<ul style="list-style-type: none"> <li>• IMO Resolution MEPC.185(59)</li> <li>• IMO Circular MEPC.1/Circ.680</li> </ul>
<b>(1)</b> Only where required by MARPOL 73/78 Convention, according to the ship's gross tonnage.		
<b>(2)</b> Only where ozone-depleting substances are used on board.		

Table 4 : Required plans and documents

Notation	Documents	Approval status	
CLEANSHIP CLEANSHIP SUPER	General: <ul style="list-style-type: none"> <li>• general arrangement plan with indication of the waste collection and conveying circuits, storage means and treatment installations intended for the prevention of pollution by oil, sewage, grey waters, garbage and hazardous packaged substances</li> <li>• capacity plan</li> <li>• program for a waste source reduction, minimization and recycling</li> </ul>	I  I A	
	Prevention of pollution by oil: <ul style="list-style-type: none"> <li>• diagram of the oil residue (sludge) system,</li> <li>• diagram of the independent clean drain system, where provided</li> <li>• diagram of the oily bilge system (pumping, treatment, discharge)</li> <li>• details of the bilge water holding tank</li> <li>• calculation of the bilge water holding tank capacity</li> </ul>	I I I A A	
	Prevention of pollution by sewage and wastewater: <ul style="list-style-type: none"> <li>• diagram of the grey water system (collection, treatment, discharge)</li> <li>• diagram of the sewage system (collection, treatment, discharge)</li> <li>• details of the sewage holding tank and grey water holding tank</li> <li>• calculation of the sewage holding tank and grey water holding tank capacity</li> <li>• description of the sewage treatment plant or comminuting/disinfecting system</li> </ul>	I I A A I	
	Prevention of pollution by garbage: <ul style="list-style-type: none"> <li>• general information on the equipment intended for collecting, storing, processing and disposing of garbage (except where type-approved)</li> <li>• calculation of the necessary storing, processing and disposing capacities</li> <li>• diagram of control and monitoring systems for garbage handling equipment</li> </ul>	I A A	
	Prevention of pollution by oil spillage and leakage: <ul style="list-style-type: none"> <li>• diagram of the fuel oil and lubricating oil overflow systems</li> <li>• diagram of the fuel oil and lubricating oil filling, transfer and venting systems</li> <li>• arrangement of the fuel oil and lubricating oil spillage containment systems</li> <li>• diagram of the control and monitoring system for fuel oil filling, transfer and overflow systems</li> <li>• diagram of the stern tube lubricating oil system</li> </ul>	A I A I A	
	Prevention of oil pollution in case of collision or stranding: <ul style="list-style-type: none"> <li>• arrangement of the fuel oil tanks, lubricating oil tanks and sludge tanks with indication of the volume and of the distance between the tank and the ship base line/ship shell side</li> </ul>	I	
	Prevention of pollution by anti-fouling systems: <ul style="list-style-type: none"> <li>• specification of antifouling paint</li> </ul>	A	
	Prevention of pollution by refrigerants and fire-fighting media: <ul style="list-style-type: none"> <li>• arrangement of retention facilities including material specifications, structural drawings, welding details and procedures, as applicable</li> <li>• means to isolate portions of the plant so as to avoid release of medium</li> </ul>	A A	
	AWT-A AWT-B AWT-A/B	<ul style="list-style-type: none"> <li>• diagram of the grey water system (collection, treatment, discharge)</li> <li>• diagram of the sewage system (collection, treatment, discharge)</li> <li>• details of the sewage holding tank and grey water holding tank</li> <li>• calculation of the sewage holding tank and grey water holding tank capacity</li> <li>• description of the AWT plant and relevant operating principles</li> </ul>	I I A A I
	<b>Note 1:</b> I = to be submitted for information A = to be submitted for approval A/I = to be submitted for approval or information, in accordance with the relevant Rules or Rule Note. <b>Note 2:</b> Diagrams are to include information about monitoring and recording of parameters.		



Notation	Documents	Approval status
<b>BWE</b>	See IMO Resolution MEPC.149(55) and Pt C, Ch 1, Sec 10	A / I
<b>BWT</b>	See Regulation 5.7 of IMO Resolution MEPC.279(70) or Regulation 5.1 of IMO Resolution MEPC.174(58), as appropriate, and Pt C, Ch 1, Sec 10	A / I
<b>EGCS-SCRUBBER</b>	<ul style="list-style-type: none"> <li>Specifications and operating instructions of EGCS unit</li> </ul>	I
<b>GREEN PASSPORT</b>	See Rule Note NR528	A / I
<b>GWT</b>	<ul style="list-style-type: none"> <li>diagram of the grey water system (collection, treatment, discharge)</li> <li>details of the grey water holding tank</li> <li>calculation of the grey water holding tank capacity</li> <li>description of the grey water treatment plant and relevant operating principles</li> </ul>	I A A I
<b>HVSC</b>	See Rule Note NR557	A / I
<b>NDO-x days</b>	Calculation of the storage capacity for solid wastes and liquid effluents	A
<b>NOX-x%</b>	<ul style="list-style-type: none"> <li>calculation of the weighted average NOx emission level of the ship</li> <li>calculation of the weighted average IMO Tier II NOx emission limit of the ship</li> </ul>	A A
<b>OWS-x ppm</b>	Description of the OWS plant and relevant operating principles	I
<b>SOX-x%</b>	<p>Where low sulphur fuel oils are used:</p> <ul style="list-style-type: none"> <li>diagram of the fuel oil supply systems</li> <li>change-over procedure</li> </ul> <p>Where an exhaust gas cleaning system is fitted:</p> <ul style="list-style-type: none"> <li>description of the system and relevant operating principles</li> </ul>	I I I
<b>VCS</b>	See Ch 11, Sec 7	A / I
<p><b>Note 1:</b>  I = to be submitted for information  A = to be submitted for approval  A/I = to be submitted for approval or information, in accordance with the relevant Rules or Rule Note.  <b>Note 2:</b> Diagrams are to include information about monitoring and recording of parameters.</p>		

## SECTION 2

# DESIGN REQUIREMENTS FOR THE NOTATIONS CLEANSHIP AND CLEANSHIP SUPER

### 1 General

#### 1.1 Application

**1.1.1** The requirements of this Section apply to ships having the additional class notations **CLEANSHIP** and **CLEANSHIP SUPER**.

Requirements for onboard surveys are given in Ch 9, Sec 4 and Pt A, Ch 5, Sec 7.

**1.1.2** Ships having the additional class notation **CLEANSHIP** are to comply with the provisions of Article [2].

Ships having the additional class notation **CLEANSHIP SUPER** are to comply with the provisions of Articles [2] and [3].

#### 1.2 Documents to be submitted

##### 1.2.1 Certificates

The certificates to be submitted for the additional class notations **CLEANSHIP** and **CLEANSHIP SUPER** are listed in Ch 9, Sec 1, Tab 2.

##### 1.2.2 Operational procedures

The operational procedures to be submitted for the additional class notation **CLEANSHIP** are listed in Ch 9, Sec 1, Tab 3.

##### 1.2.3 Plans and documents

The plans and documents to be submitted for the additional class notations **CLEANSHIP** and **CLEANSHIP SUPER** are listed in Ch 9, Sec 1, Tab 4.

### 2 Design requirements for the additional class notation CLEANSHIP

#### 2.1 Waste management

##### 2.1.1 Waste generation

The waste quantities to be considered for the calculation of:

- the volume of the holding tanks
- the capacity of the waste treatment and storage equipment

are to be derived from the experience gained on similar types of ships operated in similar conditions. Where no data are available, the figures listed in Tab 1 are to be used.

##### 2.1.2 Separation of waste streams

Design arrangements and procedures for collecting, sorting, treating, storing and discharging solid and liquid waste and harmful substances are to be such that the discharge or discharge prohibition criteria laid down in annexes I, IV and V of MARPOL 73/78 Convention can be fulfilled.

**Table 1 : Waste generation quantities**

No	Type of Waste	Unit	Quantities for			
			Cruise ships	Ro-ro passenger ships designed for night voyages	Ro-ro passenger ships designed for day voyages	Cargo ships
1	Plastics	kg/person/day	0,1	0,1	0,1	0,1
2	Paper and cardboard	kg/person/day	1,0	1,0	1,0	1,0
3	Glass and tins	kg/person/day	1,0	1,0	1,0	1,0
4	Food wastes	kg/person/day	0,7	0,7	0,7	0,7
5	Total garbage (1 + 2 + 3 + 4)	kg/person/day	2,8	2,8	2,8	2,8
6	Black water	litres/person/day	12 for a vacuum system 100 for a conventional flushing system			
7	Grey water (excluding laundry and galley)	litres/person/day	160	150	50	100
8	Laundry	litres/person/day	80	20	20	40
9	Galley	litres/person/day	90	30	30	60
10	Total grey water (7 + 8 + 9)	litres/person/day	330	200	100	200

Generally, this implies that the following categories of wastes are separated before any treatment or storage:

- products containing hazardous substance, as defined in Ch 9, Sec 1, [2.1.1]
- plastics, which have to be separated from wastes ultimately discharged to sea (sewage or food wastes for instance)
- sewage, including drainage from medical premises, which has to be collected separately from grey water, except if a common treatment installation is installed on board.

Note 1: This does not preclude the mixing of effluents after treatment (e.g. treated sewage mixed with grey water).

Note 2: When sea water is mixed with wastewater (e.g. for the purpose of washing the holding tanks), the discharge requirements for the wastewater apply to the resulting mixture.

Note 3: When categories of wastewater having different discharge requirements are mixed together, the most stringent requirements apply to the resulting mixture.

### 2.1.3 Incineration and disposal

Although disposal into the sea and onboard incineration are possible in the conditions specified in MARPOL 73/78 Convention, storage and subsequent discharge to port reception facilities is to be given first priority.

Except otherwise stated in this Article, storage arrangements are to be provided for all kinds of liquid and solid wastes, with a capacity corresponding to one day operation of the ship.

Note 1: The attention is drawn to the specific requirements imposed by certain flag Authorities and/or State or Port Administration, which may restrict or prohibit waste discharge and/or incineration in the waters under their jurisdiction.

## 2.2 Oily wastes

### 2.2.1 Compliance with MARPOL 73/78

Ships granted with the additional class notation **CLEANSHIP** have to comply with the following requirements of MARPOL 73/78 Convention, Annex I, and with the relevant unified interpretations:

- Reg. 12 for arrangement and capacity of oil residues (sludge) tanks
- Reg. 13 for standard discharge connection
- Reg. 14 for oil filtering equipment
- Reg. 15 for oil discharge criteria
- Reg. 17 for oil record book (machinery space operations).

### 2.2.2 Bilge water holding tank

All machinery space bilges and spaces containing hydraulic equipment have to be drained into a bilge water holding tank before separation and oil filtration or discharge ashore. This bilge holding tank is to be separate and independent from the sludge tanks.

Sea or freshwater drains not contaminated by oil may be discharged overboard.

For ships operating with heavy fuel oil having a relative density greater than 0,94 at 15°C, the bilge water holding tank is to be fitted with heating facilities, except if the oily water separator capability to efficiently treat the oily water at ambient temperatures (without heating) is justified.

The bilge water holding tank is to be arranged so as to facilitate the separation of any oil (or oil emulsions resulting from the use of bilge cleaning agents) from the bilge water and the removal of accumulated sediments.

The shore discharge piping system from the bilge water holding tank is to be terminated by the standard discharge connection specified in MARPOL 73/78 Convention, Annex I, Reg. 13.

### 2.2.3 Oil water separating equipment

The following approved equipment is to be provided in accordance with IMO Resolution MEPC.107(49):

- 15 ppm bilge separator
- 15 ppm bilge alarm
- automatic stopping device.

The capacity of the bilge separator is to take into account the route of the vessel, the volume of the bilge water holding tanks and the separating technology.

The 15 ppm bilge separator and the 15 ppm bilge alarm are to be installed in accordance with the provisions of IMO Resolution MEPC.107(49), paragraph 6.

### 2.2.4 Oil residue (sludge) tanks

Oil residue (sludge) may be disposed of directly from the oil residue (sludge) tanks through the standard discharge connection referred to in MARPOL 73/78, Annex I, Reg. 13, or any other approved means of disposal.

### 2.2.5 Overboard discharges from the bilge pumping system

The overboard discharge valve of any bilge overboard discharge line, unless passing through the 15 ppm bilge separator, is to be kept shut and provided with lead-sealing arrangements.

### 2.2.6 Segregation of oil and water ballast

No ballast water is to be carried in any fuel oil or lubricating oil tank.

### 2.2.7 Discharge records

Provisions are to be made to record the following parameters related to the oily water discharge:

- date and time of the discharge
- ship location
- quantity and oil content of oily water discharged.

## 2.3 Wastewaters

### 2.3.1 Compliance with MARPOL 73/78

Ships granted with the additional class notation **CLEANSHIP** have to comply with the relevant requirements of MARPOL 73/78 Convention, Annex IV, revised according to IMO Resolution MEPC.115(51):

- Reg. 10 for standard discharge connection
- Reg. 11 for discharge criteria.

Note 1: Discharge of grey water is not regulated by MARPOL 73/78 Convention.

Note 2: Attention is drawn to the fact that some national regulations prohibit the discharge of sewage (treated or untreated) and grey water while in port or within other designated areas.

### 2.3.2 Design and arrangement of the sewage system

The ship is to be equipped with one of the following sewage systems:

- a sewage treatment plant, or
- a sewage comminuting and disinfecting system fitted with facilities for temporary storage of sewage when the ship is less than 3 nautical miles from the nearest land, or
- a holding tank of the capacity to the satisfaction of the Society for the retention of all sewage, having regard to the operation of the ship, the number of persons on board and other relevant factors.

### 2.3.3 Holding tanks

The holding tanks are to be efficiently protected against corrosion and fitted with a level indicator and a high level alarm.

### 2.3.4 Sewage treatment plants and piping

Sewage treatment plants are to be of a type approved in accordance with the provisions of IMO Resolution MEPC.227(64).

Provisions are to be made in the design for easy access points for the purpose of obtaining representative influent and effluent samples.

### 2.3.5 Discharge records

Provisions are to be made to record the following parameters related to the sewage discharge:

- date and time of discharge
- position of the ship (latitude and longitude)
- quantity of sewage discharged.

## 2.4 Garbage and hazardous wastes

### 2.4.1 Compliance with MARPOL 73/78

Ships granted with the additional class notation **CLEANSHIP** have to comply with the requirements of MARPOL 73/78, Annex V:

- Reg. 3, 4, 5 and 6 for disposal into the sea criteria
- Reg. 9 for placards, garbage management plans and garbage record-keeping.

### 2.4.2 Garbage management plan

Procedures for collection, sorting, processing and disposal of garbage are to be available in the garbage management plan required by MARPOL 73/78, Annex V, Reg. 9.

The garbage management plan is to include procedures in order to make sure that the following hazardous wastes are not discharged at sea nor mixed with other waste streams:

- photo processing waste (including X-ray development fluid waste)
- dry cleaning waste, containing in particular tetrachloroethylene or perchloroethylene (PERC)
- printing materials, like inks, except soy based, non chlorinated hydrocarbon based ink products
- laser printer toner cartridges
- unused and outdated pharmaceuticals
- fluorescent / mercury vapour bulbs
- batteries
- used cleaners, solvents, paints and thinners
- products containing metals such as lead, chromium, copper, cadmium and mercury.

### 2.4.3 Handling of hazardous waste

Hazardous wastes are to be collected and stored in separate leakproof containers prior to disposal ashore. The storage capacity is to be sufficient for the average production of 30 days. The contents of all containers are to be clearly marked.

Note 1: Waste fluids associated with photo processing, including X-ray development, may be treated to remove silver for recycling. The effluent from the recovery unit may be led to the grey water provided it contains less than 5 parts per million (ppm). The residues from the recovery unit are to be landed ashore for disposal or recycling.

### 2.4.4 Collection of garbage

Garbage bins are to be placed at suitable places and within a suitable distance in accommodation spaces and open decks.

Hazardous wastes, plastics and food contaminated wastes are to be collected separately from other wastes.

### 2.4.5 Storage of garbage

The ship is to have sufficient capacity to store all kinds of garbage produced during one day, taking into account the daily waste generation figures given in [2.1.1] and the values of density given in Tab 2.

If incineration is permitted in the areas where the ship is intended to operate, the needed capacity for wastes other than glass and tins may be reduced by 40%, without being less than the needed volume corresponding to one day.

**Table 2 : Waste density**

Type of waste	Density (kg/m <sup>3</sup> )	
	Compacted waste	Uncompacted waste
Glass, tin	1600	160
Paper, cardboard, plastic	410	40
Food wastes	–	300

### 2.4.6 Food wastes

Arrangements are to be made to store food wastes prior to discharge to port reception facilities or, where permitted, disposal into the sea.

The onboard storage capacity is to be sufficient for one day food waste production, taking into account the figures given in [2.1.1] and the values of density given in Tab 2.

Where food waste disposal into the sea is permitted, precautions are to be taken to ensure that plastics contaminated by food wastes, like plastic food wrappers, are not discharged to sea with other food wastes.

### 2.4.7 Incinerators

Where fitted, incinerators are to be type-approved by the Society, designed and constructed according to the requirements of:

- MEPC.76(40), as amended by MEPC.93(45)
- MARPOL Annex VI, Appendix IV.

Proper hazardous waste management procedures including segregating hazardous wastes are to be instituted onboard each ship to assure hazardous wastes are not introduced into the incinerator. In particular, batteries are to be removed from any waste that will be incinerated onboard.

Ashes containing toxic or heavy metal residues are to be kept on board in a suitable container and landed ashore for disposal. Other ashes may be discharged at sea where permitted.

Note 1: Ashes are considered as free from toxic or heavy metal residues when metal analysis show that the limit concentrations given in Tab 3 are not exceeded.

**Table 3 : Limit concentrations of toxic and heavy metals substances in ashes**

Substance	Limit concentration (ppm)
Arsenic	0,30
Barium	4,00
Cadmium	0,30
Chromium	5,00
Lead	1,50
Mercury	0,01
Selenium	0,30
Silver	0,20

### 2.4.8 Discharge records

Provisions are to be made to record the following parameters related to the garbage discharge:

- date and time of discharge
- ship location (latitude and longitude) or location of ashore discharge facilities
- estimated amounts discharged for each category, including incinerator ash (in cubic meters).

## 2.5 Hull antifouling systems

### 2.5.1 Compliance with IMO AFS Convention

Ships granted with the additional class notation **CLEANSHIP** have to comply with the relevant requirements of IMO Convention on the Control of Harmful Anti-fouling Systems on Ships, 2001, requiring the complete prohibition of organotin compounds which act as biocides in anti-fouling systems.

### 2.5.2 Type-approval of anti-fouling systems

Anti-fouling paints are to be of a type approved by the Society, on the basis of the following criteria:

- the product is to be TBT-free
- small quantities of organotin compounds acting as a chemical catalyst are allowed provided their concentration does not exceed 2500 mg total tin per kg of dry paint.

## 2.6 Prevention of pollution by oil spillage and leakage

### 2.6.1 Compliance with MARPOL 73/78

Ships granted with the additional class notation **CLEANSHIP** have to comply with MARPOL 73/78 Convention, Annex I, regulation 12A (Oil fuel tank protection).

### 2.6.2 Overflow systems

All fuel and lubricating oil tanks the capacity of which exceeds 10 m<sup>3</sup> are to be fitted with an overflow system and a high level alarm or a flow alarm in the overflow system. The alarm signal is to be given where the person in charge of the bunkering or transfer operation will normally be located.

Note 1: As an alternative to the overflow system, the Society may accept spill deck containment system in way of the concerned tank, provided it has a capacity:

- of at least that required in [2.6.3], and
- commensurate with the maximum expected filling flow rate of the tank and the time necessary to activate the shutdown of the transfer pump in case of high level in the tank.

Note 2: The overflow system is to comply with the provisions of Pt C, Ch 1, Sec 10, [9.3].

### 2.6.3 Containment systems

On the weather and superstructure decks, each fuel or lubricating oil tank vent, overflow and fill pipe connection and each other area where oil spillage may occur is to be fitted with a fixed deck container or enclosed deck area with a capacity of:

- 80 litres if the gross tonnage of the ship is between 300 and 1600
- 160 litres if the gross tonnage of the ship is greater than 1600.

The deck container or area is to be fitted with a closed drainage system.

Note 1: As an alternative arrangement to the closed drainage system, the Society may accept manual draining by gravity or by means of a portable pump, in conjunction with a suitable procedure covering the draining operation, the disposal of the drained oil and the cleaning of the container.

### 2.6.4 Stern tube leakage

Sealing glands are to be provided with an oil leak prevention air seal or the stern tube oil is to be of a non-toxic and biodegradable quality approved in accordance with recognized standards.

The oil tanks are to be fitted with a level sensor giving an alarm in case of low level. Arrangements are to be made to record the level of those tanks.

All oil filling or topping up operations are to be recorded.

### 2.6.5 Oily condensates from venting pipes

Venting pipes from machinery spaces and containing hydrocarbon vapours are to be led to a venting box provided with a draining pipe connected to a suitable oily drain tank.

## 2.7 Refrigeration systems

### 2.7.1 Application

The following requirements apply to the ship centralized refrigerating plants, centralized air conditioning plants and gas reliquefaction plants.

They do not apply to the refrigeration facilities intended for the storage of the galley supplies and to the air conditioning plants for limited parts of the ship, such as the control rooms and the wheelhouse.

### 2.7.2 Compliance with MARPOL 73/78

Ships granted with the additional class notation **CLEANSHIP** have to comply with MARPOL 73/78 Convention, Annex VI, regulation 12 (Ozone Depleting Substances).

### 2.7.3 Acceptable refrigerants

The use of halogenated substances, including hydrochloro-fluorocarbons (HCFCs), as refrigerant is prohibited.

### 2.7.4 Retention facilities

Refrigeration systems are to be fitted with retention facilities having the capability to retain the volume of refrigerant contained in the largest individual refrigeration unit, should the necessity arise to empty any one unit. The retention facilities may be either:

- fully independent from the refrigeration system, i.e. separate tanks, or
- part of the refrigeration system, i.e. redundant condensers: In this case, the combined capacity of the condensers is to be sufficient to store the total volume of refrigerant in the system considering that any one condenser is unavailable e.g. for repair or maintenance reasons.

The retention facilities may be tanks for liquid media and/or bottles for gaseous media. If only tanks for liquid are used as retention facilities, one or more compressors having the combined capacity to discharge completely the medium from the system into the tanks are to be installed.

### 2.7.5 Prevention of leakage

Refrigeration systems are to be designed in such a way as to minimise the risk of medium release in the case of maintenance, repair or servicing. Arrangements are to be made to isolate those sections which are to be serviced by a system

of valves and by-passes, in such a way as not to stop the operation of the plant, while in service, preventing the risk of release of the medium outside of the plant.

Means are to be provided to avoid the possibility of leak to the atmosphere of the refrigerants or its vapours in any case of failure of the plant.

A warning instruction plate stating that deliberate emissions of halogenated substances is prohibited is to be displayed in the vicinity of the vessels and of the releasing devices.

Note 1: This requirement does not apply to spaces containing only pipes

### 2.7.6 Leak detection

The spaces where the medium might be likely to leak are to be continuously monitored by appropriate leak detectors, which are to be of a type approved by the Society.

### 2.7.7 Alarm

Any detection of medium leak is to activate an audible and visible alarm in a normally manned location. The alarm is to be activated when the concentration of refrigerant reaches a value agreed with the Society on a case by case basis.

## 2.8 Fire-fighting systems

### 2.8.1 Compliance with MARPOL 73/78

Ships granted with the additional class notation **CLEANSHIP** have to comply with MARPOL 73/78 Convention, Annex VI, regulation 12 (Ozone Depleting Substances).

### 2.8.2 Acceptable fire-fighting media

The use of halon and halocarbons media in the fixed and portable fire fighting equipment is prohibited.

### 2.8.3 Design requirements for fire-fighting systems

Provisions are to be made for the safe containment and disposal of fire-fighting media in case of spillage during maintenance or repair.

## 2.9 Emission of nitrogen oxides (NOx)

### 2.9.1 Compliance with MARPOL 73/78

Diesel engines fitted to ships granted with the additional class notation **CLEANSHIP** have to comply with the requirements of:

- MARPOL 73/78, Annex VI, Reg. 13
- NOx Technical Code (2008).

### 2.9.2 Application

The following requirements apply to all diesel engines, independently of the service, with a rated power of more than 130 kW, installed on the ship, with the exceptions of:

- emergency diesel engines, diesel engines installed in lifeboats and any other diesel engines intended to be used solely in an emergency situation, independently of their rated power
- engines which are subject to alternative measures for limiting NOx emission, under special consideration of the Society.

Note 1: NOx emissions from gas only engines, gas turbines, boilers and incinerators are not subject to these requirements.

### 2.9.3 NO<sub>x</sub> certification of engines

Prior to installation onboard the ship, engines have to be NO<sub>x</sub>-certified in accordance with the relevant provisions of the NO<sub>x</sub> Technical Code for the intended application. A valid EIAPP certificate (or statement of compliance) is normally to be issued by the Society.

### 2.9.4 NO<sub>x</sub> reduction methods

Where NO<sub>x</sub> reduction methods (such as water injection, fuel oil emulsification, charge air humidification, exhaust gas after-treatment) are used, they are to be approved by the Society and taken into account in the EIAPP certificate of the engine.

The measurement of NO<sub>x</sub> emission levels, where required for the control of the reduction process (e.g. to adjust the injection rate of the reduction agent for SCR systems), is to be carried out by means of type-approved analysers.

### 2.9.5 Urea solutions used for SCR systems

The storage tank is to be protected from excessively high or low temperatures applicable to the particular concentration of the solution. Depending on the operational area of the ship, this may necessitate the fitting of heating and/or cooling systems. The physical conditions recommended by applicable recognized standards (such as ISO 18611-3) are to be taken into account to ensure that the contents of the aqueous urea tank are maintained to avoid any impairment of the urea solution during storage.

## 2.10 Emission of sulphur oxides (SO<sub>x</sub>)

### 2.10.1 Compliance with MARPOL 73/78

Ships granted with the additional class notation **CLEANSHIP** have to comply with the relevant requirements of MARPOL 73/78 Convention, Annex VI and related Guidelines:

- Reg. 13 for Sulphur Oxides (SO<sub>x</sub>) and Particulate Matter
- Reg. 18 and Appendices V and VI for fuel oil quality
- IMO Resolution MEPC.182(59) for the sampling of fuel oil.

### 2.10.2 Use of low sulphur fuel oils

Where several types of fuel are used in pursuance of [2.10.1], arrangements are to be made to allow the complete flushing of the high sulphur fuel supply system before entering the emission control area (ECA).

Arrangements are to be made to record the following parameters:

- volume of fuel oil in each tank
- date, time and position of the ship when the fuel change-over operation is completed or started (respectively when entering the ECA or leaving the ECA).

### 2.10.3 Use of exhaust gas cleaning systems

Exhaust gas cleaning (EGC) systems, which may be accepted as an arrangement equivalent to the use of low sulphur fuel oils in pursuance of MARPOL 73/78 Convention, Annex VI, Regulation 4.1, are to be approved in accordance with IMO Resolution MEPC.259(68): 2015 Guidelines for exhaust gas cleaning systems.

EGC systems are to be fitted with data measuring, recording and processing devices in accordance with the aforesaid Resolution.

The discharge washwater is to satisfy the criteria given in the aforesaid Resolution.

Washwater treatment residues generated by the EGC unit are to be stored in a holding tank having a capacity sufficient for 30 days operation of the ship, then delivered ashore to adequate reception facilities. Such residues are not to be discharged to the sea or incinerated on board.

## 3 Additional design requirements for the additional class notation CLEANSHIP SUPER

### 3.1 Waste minimization and recycling program

**3.1.1** Direct waste minimization and recycling programs involving significant reduction of the waste amounts mentioned in Tab 1 are to be implemented. Such programs are to cover the influence of measures such as:

- use of technical water (e.g. air conditioning condensate) where possible
- use of water recovery systems (e.g. filtering and reuse of laundry water - last rinse use for first wash)
- reclamation and reuse of properly treated and filtered wastewaters as technical water (e.g. in toilet flushing, laundry, open deck washing)

Note 1: Effluents from water treatment plants may be reused or recycled only if they comply with a recognised quality standard for potable water.

- active water conservation (e.g. use of reduced flow shower heads, vacuum systems for toilets, laundry equipment that utilizes less water)
- use of reusable packaging and bulk packaging
- replacement of plastic packaging by containers built in other material
- minimization of the amount of oily bilge water and processing of the oily bilge water and oil residue (sludge) in accordance with the Integrated Bilge Water Treatment System (IBTS) concept (see IMO Circular MEPC.1/Circ.642).

**3.1.2** In addition to the procedures required in [2.4.2], the procedures for garbage source reduction, minimization and recycling are to be available in the garbage management plan.

### 3.2 Oily wastes

**3.2.1** The bilge water holding tank is to have a capacity that provides to the ship the flexibility of operation in ports, costal waters and special areas, without the need to discharge de-oiled water overboard. The minimum capacity of the bilge water holding tank is not to be less than the greater of the two following values (in m<sup>3</sup>):

- 0,075 S, where S is the surface of the vertical projection, in m<sup>2</sup>, of the largest machinery space drained into the bilge holding tank
- the value calculated from Tab 4.

**Table 4 : Minimum capacity of the bilge water holding tank according to main engine rating**

Main engine rating (kW) (1)	Capacity (m <sup>3</sup> )
up to 1000	1,5
above 1000 up to 20000	$1,5 + (P - 1000) / 1500$
above 20000	$14,2 + 0,2 (P - 20000) / 1500$
(1) For diesel-electric propulsions, the main engine rating is to be substituted with the aggregate power of the electric power motors.	

### 3.3 Wastewaters

#### 3.3.1 Design and arrangement of the sewage and grey water systems

The ship is to be fitted with a sewage system and a grey water system designed and arranged as follows:

- an approved sewage treatment plant or sewage comminuting and disinfecting system is to be provided
- a tank is to be provided for the storage of untreated or treated sewage with a capacity complying with [3.3.2]
- a tank is to be provided for the storage of grey waters with a capacity complying with [3.3.2]
- grey waters from galleys are to be collected separately from other grey waters and led through a grease trap prior to additional treatment, storage or discharge.

Note 1: Treated sewage and grey water holding tanks may be combined together.

Note 2: Plastic garbage is to be separated from sewage and/or grey waters before entering the treatment unit.

#### 3.3.2 Holding tanks

Holding tanks for sewage and grey water are to have a capacity sufficient for 24 hours operation of the ship, having regard to the maximum number of persons on board, the daily production of wastewater given in Tab 1 and other relevant factors.

#### 3.3.3 Sewage sludges

Sludges from sewage treatment are to be collected and stored then discharged ashore or, where permitted, incinerated onboard.

Where provided, incineration devices are to completely burn the sludges to a dry and inert ash and not to discharge fly ash, malodors or toxic substances.

The capacity of the sewage sludge tanks is to be calculated taking into consideration:

- the maximum period of voyage between ports where sludge can be discharged ashore, or
- the incinerator capacity and whether incineration is permitted in the areas where the ship is intended to operate.

In the absence of precise data, a figure of 30 days is to be used.

Ashes from sludge incineration are to be disposed ashore except where permitted under [2.4.7].

#### 3.3.4 Discharge records

Provisions are to be made to record the following parameters related to the sewage and grey water discharges:

- date and time of discharge
- position of the ship (latitude and longitude)
- quantity of sewage and/or grey water discharged
- quantity of sludges incinerated or discharged ashore.

### 3.4 Food wastes

3.4.1 Food wastes and wastes contaminated with food are to be stored in high integrity sealed packaging and refrigerated to 5°C.

### 3.5 Prevention of pollution by oil spillage and leakage

#### 3.5.1 Containment systems

A seven-barrel spill kit containing the following is to be available on board, ready to be used during bunkering operation:

- sorbents sufficient to absorb seven barrels of oil
- non-sparking hand scoops, shovels and buckets
- portable containers suitable for holding seven barrels of recovered solid waste and seven barrels of recovered liquid waste
- a minimum of 60 litres of a deck cleaning agent
- appropriate protective clothing to protect personnel from inhalation hazards, eye exposure and skin contact
- non-sparking portable pumps with appropriate hoses.

#### 3.5.2 Oil detection in cooling water circuits

Hydrocarbon detectors are to be provided in sea water and fresh water cooling systems comprising fuel oil or lubricating oil heat exchangers in order to detect any contamination of the water.

### 3.6 Protection against oil pollution in the event of collision or grounding

3.6.1 All fuel oil and lubricating oil tanks are to be located in protected locations in accordance with the provisions of Pt C, Ch 1, Sec 10, [11.5.3].

Note 1: For the purpose of application of this requirement, tanks containing oil residues (sludges) are to be considered as fuel oil tanks.

Note 2: This requirement does not apply to engine lubricating oil drain tanks.

### 3.7 Prevention of air pollution

3.7.1 All refrigerants used onboard are to have:

- a Global Warming Potential (GWP) not exceeding 2000
- an Ozone Depleting Potential (ODP) equal to zero.



## SECTION 3

# DESIGN REQUIREMENTS FOR THE POLLUTION PREVENTION NOTATIONS OTHER THAN CLEANSHIP AND CLEANSHIP SUPER

### 1 General

#### 1.1 Application

**1.1.1** The requirements of this Section apply to ships having one of the additional class notations for pollution prevention listed in Ch 9, Sec 1 other than **CLEANSHIP** and **CLEANSHIP SUPER**.

Requirements for onboard surveys are given in Ch 9, Sec 4 and in Pt A, Ch 5, Sec 7.

#### 1.2 Documents to be submitted

##### 1.2.1 Certificates

The certificates to be submitted for the aforementioned additional class notations are listed in Ch 9, Sec 1, Tab 2.

##### 1.2.2 Operational procedures

The operational procedures to be submitted for the aforementioned additional class notations are listed in Ch 9, Sec 1, Tab 3.

##### 1.2.3 Plans and documents

The plans and documents to be submitted for the aforementioned additional class notations are listed in Ch 9, Sec 1, Tab 4.

### 2 Additional class notations AWT-A, AWT-B and AWT-A/B

#### 2.1 Scope

**2.1.1** The additional class notations **AWT-A**, **AWT-B** and **AWT-A/B** apply to ships fitted with an advanced wastewater treatment (AWT) plant, capable of treating both sewage and grey waters with an effluent quality complying with the relevant provisions of [2.3.2].

Note 1: Effluents from the AWT plant may be reused or recycled only if they comply with a recognised quality standard for potable water.

#### 2.2 Definitions and abbreviations

##### 2.2.1 Thermotolerant coliforms (TC)

Thermotolerant coliforms means the group of coliform bacteria which produce gas from lactose in 48 hours at 44.5°C.

Note 1: Thermotolerant coliforms are sometimes referred to as "fecal coliforms". The term thermotolerant coliforms is now accepted as more appropriate, since not all of these organisms are of faecal origin.

##### 2.2.2 TRC

TRC means Total Residual Chlorine. TRC is the chlorine remaining in wastewater at the end of a specified contact period as combined or free chlorine.

##### 2.2.3 TSS

TSS is the pollutant parameter total suspended solids.

#### 2.3 Design of the AWT plant

##### 2.3.1 Required capacity

The capacity of the AWT plant is to be sufficient for the maximum number of persons onboard, taking into account the sewage and grey water quantities given in Ch 9, Sec 2, [2.1.1].

##### 2.3.2 Type approval

AWT plants are to be of a type approved in accordance with the effluent standards mentioned in Tab 1.

**Table 1 : Effluent standards to be applied for the type approval of AWT plants**

Notation	Effluent standards to be applied		
	Standards given in IMO Resolution MEPC.227(64), paragraph 4.1	Standards given in Tab 2	Standards given in Tab 3
<b>AWT-A</b>	X	X	
<b>AWT-B</b>	X		X
<b>AWT-A/B</b>	X	X	X

**Table 2 : Additional effluent standards for the type approval of AWT plants - Notation AWT-A**

Parameter	Limit	Reference of the standard
Thermotolerant coliform (TC)	14 TC / 100 ml (1)	Alaska Department of Environmental Conservation - General permit 2013DB0004, effective August 29, 2014
Total suspended solid (TSS)	30 $Q_i/Q_e$ mg/l (1) (2)	
Total residual chlorine (TRC)	7,5 µg/l	
(1) Geometric mean of the samples taken during the test period.		
(2) The dilution factor $Q_i/Q_e$ is equal to the ratio of the influent $Q_i$ (sewage, grey water and other liquid streams to be processed by the treatment plant) to the effluent $Q_e$ (treated wastewater produced by the treatment plant).		

**Table 3 : Additional effluent standards for the type approval of AWT plants - Notation AWT-B**

Parameter	Limit	Reference of the standard
Total nitrogen	20 $Q_i/Q_e$ mg/l or at least 70% reduction (1) (2)	IMO Resolution MEPC.227(64), paragraph 4.2
Total phosphorus	1,0 $Q_i/Q_e$ mg/l or at least 80% reduction (1) (2)	IMO Resolution MEPC.227(64), paragraph 4.2
(1) The dilution factor $Q_i/Q_e$ is equal to the ratio of the influent $Q_i$ (sewage, grey water and other liquid streams to be processed by the treatment plant) to the effluent $Q_e$ (treated wastewater produced by the treatment plant).		
(2) Reduction in relation to the load of the influent.		

### 3 Additional class notation BWE

#### 3.1 Scope

**3.1.1** The additional class notation **BWE** applies to ships intended for ballast water exchange at sea and whose design is in compliance with the technical provisions of BWM convention (2004), Regulation D-1, and with the requirements of this article.

#### 3.2 Design requirements

##### 3.2.1 Design of the pumping and piping systems

The pumping and piping systems involved in the ballast water exchange are to comply with the provisions of Pt C, Ch 1, Sec 10, [7].

##### 3.2.2 Sediment handling

Arrangements are to be made for:

- monitoring the sediment build up
- cleaning the tanks and removing the sediments
- disposing the sediments to reception facilities.

##### 3.2.3 Discharge records

Provisions are to be made to get and record the following parameters related to the ballast water discharge:

- date and time of discharge
- ship location (latitude and longitude)
- amounts of water exchanged
- amount of sediments disposed to reception facilities.

### 4 Additional class notation BWT

#### 4.1 Scope

**4.1.1** The additional class notation **BWT** applies to ships complying with the International Convention for the Con-

trol and Management of Ships' Ballast Water and Sediments, 2004 and to the relevant Guidelines, and fitted with an approved ballast water treatment system.

#### 4.2 Design and installation requirements

##### 4.2.1 General

The ballast water treatment system is to be designed and installed in accordance with the provisions of Guidance Note NI538.

##### 4.2.2 Safety

Arrangements are to be made for the safe handling and storage of chemicals used to treat ballast water.

The risk resulting from the possible production of hazardous by-products (aqueous or gaseous) during the ballast water treatment process is to be properly addressed.

Relevant safety procedures are to be developed.

##### 4.2.3 Ballast water treatment records

Provisions are to be made to get and record the following parameters related to the ballast water discharge/treatment:

- date and time of ballast water discharge and intake (when the treatment is performed at the intake stage)
- ship location (latitude and longitude)
- date, time, duration and conditions of treatment (at intake or discharge stage, or during voyage)
- amounts of water treated.

### 5 Additional class notation GWT

#### 5.1 Scope

**5.1.1** The additional class notation **GWT** applies to ships fitted with a grey water treatment system, the effluents from which have a quality complying with [5.2].

Note 1: Effluents from the grey water treatment plant may be reused or recycled only if they comply with a recognised quality standard for potable water.

## 5.2 Design of the grey water treatment plant

### 5.2.1 Required capacity

The capacity of the grey water treatment plant is to be sufficient for the maximum number of persons onboard, taking into account the daily production of grey water given in Ch 9, Sec 2, [2.1.1].

### 5.2.2 Effluent quality

The grey water treatment plant is to be so designed that the minimum level of effluent quality complies with the limits given in IMO Resolution MEPC.227(64).

### 5.2.3 Type tests

Grey water treatment plants are to be type-approved in accordance with IMO Resolution MEPC.227(64).

## 6 Additional class notation NDO-x days

### 6.1 Scope

**6.1.1** The additional class notation **NDO-x days** applies to ships having sufficient onboard storage capacity for solid waste and liquid effluents, allowing the fully loaded ship to operate without discharging any substances into the sea during x consecutive days (no discharge period).

### 6.2 Design requirements

**6.2.1** The no discharge operation presupposes that, during the no discharge period:

- no incineration is carried out
- no waste nor effluents are discharged into the sea.

Note 1: Where the **AWT-A/B** notation is assigned to the ship, the discharge of treated sewage and treated grey water is allowed.

Note 2: Discharge of washwaters from exhaust gas cleaning (EGC) systems is not allowed during the no discharge operation. The installation of closed loop EGC systems may be considered in this respect.

**6.2.2** The storage capacity for each of the following solid and liquid wastes is to be sufficient to allow the no discharge operation of the ship during x days:

- plastics
- paper and cardboard
- glass and tins
- food waste
- sewage (see Note 1)
- grey water (see Note 1)
- sewage sludges (where applicable)
- bilge water
- oil residues (sludge)
- hazardous wastes
- washwater treatment residues from EGC units (where applicable).

Note 1: Storage capacity is not required for treated sewage and treated grey water when the notation **AWT-A/B** is assigned to the ship.

**6.2.3** Except otherwise stated, the storage capacities are to be based on:

- the maximum number of persons onboard
- the daily production of solid waste and liquid effluents given in Ch 9, Sec 2, [2.1.1].

**6.2.4** Unless otherwise justified, the minimum capacity required for the bilge water holding tank is not to be less than x times the capacity given in Ch 9, Sec 2, Tab 4.

## 7 Additional class notation NOX-x%

### 7.1 Scope

**7.1.1** The additional class notation **NOX-x%** applies to ships fitted with diesel engines having a weighted average NOx emission level not exceeding x% of the weighted average IMO Tier II limit.

The NOx performance index x is to be ≤ 90.

### 7.2 Design requirements

#### 7.2.1 General

The diesel engines to be considered are those referred to in Ch 9, Sec 2, [2.9.2].

NOx reducing devices may be considered if they are covered by the EIAPP certificate of the engine.

#### 7.2.2 Calculation of the weighted average NOx emission level of the ship

The weighted average NOx emission level of the ship  $[\text{NOx}]_{\text{ship}}$ , in g/kWh, is to be calculated as follows:

$$[\text{NOx}]_{\text{ship}} = \frac{\sum_{i=1}^n [\text{NOx}]_i \cdot P_i}{\sum_{i=1}^n P_i}$$

where:

- n : Total number of engines installed on the ship
- $[\text{NOx}]_i$  : NOx emission level of each individual engine as per EIAPP certificate, in g/kWh
- $P_i$  : Rated power of each engine, in kW.

#### 7.2.3 Calculation of the weighted average IMO Tier II NOx emission limit of the ship

The weighted average IMO Tier II NOx emission limit of the ship  $[\text{IMO}]_{\text{ship}}$ , in g/kWh, is to be calculated as follows:

$$[\text{IMO}]_{\text{ship}} = \frac{\sum_{i=1}^n [\text{IMO}]_i \cdot P_i}{\sum_{i=1}^n P_i}$$

where:

- n,  $P_i$  : As defined in [7.2.2]
- $[\text{IMO}]_i$  : Applicable IMO Tier II NOx emission limit of each individual engine as per MARPOL 73/78, Annex VI, Reg. 13.4, in g/kWh.

### 7.2.4 Calculation of the NO<sub>x</sub> performance index x

The NO<sub>x</sub> performance index x is to be calculated as follows:

$$x = \frac{[\text{NO}_x]_{\text{ship}}}{[\text{IMO}]_{\text{ship}}}$$

where:

[NO<sub>x</sub>]<sub>ship</sub>: Weighted average NO<sub>x</sub> emissions for the ship, in g/kWh, as calculated in [7.2.2]

[IMO]<sub>ship</sub>: Weighted average IMO Tier II NO<sub>x</sub> emission limit for the ship, in g/kWh, as calculated in [7.2.3].

## 8 Additional class notation OWS-x ppm

### 8.1 Scope

**8.1.1** The additional class notation **OWS-x ppm** applies to ships fitted with an oily water separator (OWS) capable of producing effluents having a hydrocarbon content not exceeding x ppm.

The OWS performance index x is to be ≤ 10.

Note 1: ppm means parts of oil per million parts of water by volume.

### 8.2 Design requirements

**8.2.1** The OWS is to be type-approved in accordance with the provisions of IMO Resolution MEPC.107(49), for an effluent quality of x ppm.

The bilge alarm and the automatic stopping device are to be efficient for the x ppm limit.

## 9 Additional class notation SO<sub>x</sub>-x%

### 9.1 Scope

**9.1.1** The additional class notation **SO<sub>x</sub>-x%** applies to ships using fuel oils complying with the following criteria:

- the sulphur content of fuel oils used in emission control areas (ECAs) is not to exceed x% of the IMO limit given in MARPOL 73/78, Annex VI, regulation 14.4
- the sulphur content of fuel oils used in other areas is not to exceed x% of the IMO limit given in MARPOL 73/78, Annex VI, regulation 14.1.

The SO<sub>x</sub> performance index x is to be ≤ 90.

Alternative arrangements may be accepted if the resulting SO<sub>x</sub> emission reduction is deemed equivalent to that corresponding to the use of fuel oils with reduced sulphur content.

### 9.2 Design requirements

#### 9.2.1 Use of fuel oils with reduced sulphur content

Where fuel oils with reduced sulphur content are used, the requirements in Ch 9, Sec 2, [2.10] are to be complied with.

### 9.2.2 Use of exhaust gas cleaning systems as alternative arrangement

Where exhaust gas cleaning systems are used, they are to be approved in accordance with IMO Resolution MEPC.259(68), for a SO<sub>x</sub> emission performance corresponding to the use of a fuel oil having a sulphur content of x% of the IMO sulphur limit applicable to ECAs.

Provisions of Ch 9, Sec 2, [2.10.3] for data measuring and recording are to be complied with.

## 10 Additional class notation EGCS-SCRUBBER

### 10.1 Scope

**10.1.1** The additional class notation **EGCS-SCRUBBER** applies to new and existing ships fitted with an exhaust gas cleaning system intended to reduce SO<sub>x</sub> emissions (Scrubber).

### 10.2 Design and installation requirements

#### 10.2.1 General

Approval, survey and certification of EGC systems are to be carried out in accordance with the provisions of IMO Resolution MEPC.259(68).

The EGC system should be capable of achieving the emission level required by MARPOL Annex VI regulation 14.4.

The scrubbers have to be designed and installed in accordance with the provisions of Pt C, Ch 1, Sec 10, [18.5].

#### 10.2.2 Scrubber installation onboard existing ships

Where scrubbers are installed aboard an existing ship, special attention is to be paid to the ship structure (e.g reinforcement in way of supporting structure), the ship stability, and the prevention of flooding and fire.

## 11 Notation CEMS

### 11.1 Scope

**11.1.1** The notation **CEMS** may be assigned as a complement to **CLEANSHIP** or **CLEANSHIP SUPER** notations, to ships fitted with a measurement, monitoring, recording and transmission equipment in compliance with this Article.

### 11.2 On-board emission measurement and monitoring equipment

**11.2.1** Ships having the notation **CEMS** are to be provided with a type-approved measurement, monitoring and recording equipment, for:

- NO<sub>x</sub> emissions, in compliance with IMO Resolution MEPC.103(49)
- SO<sub>2</sub> and CO<sub>2</sub> emissions, in compliance with IMO Resolution MEPC.259(68)

Note 1: The correspondence between the SO<sub>2</sub>/CO<sub>2</sub> ratio and the sulphur content of the fuel oil is detailed in IMO Resolution MEPC.259(68), Table 1 and Appendix II.

### 11.3 Remote transmission of the parameters related to waste discharge and air emissions

**11.3.1** The following waste discharge and air emission parameters required to be monitored and recorded are to be transmitted on a regular basis (e.g. every day) via a satellite communication system to a shipowner facility ashore:

- NO<sub>x</sub>, SO<sub>2</sub> and CO<sub>2</sub> emission records in accordance with [11.2.1]
- Oily waste discharge records, in accordance with Ch 9, Sec 2, [2.2.7]

- Wastewater discharge records, in accordance with Ch 9, Sec 2, [2.3.5], or Ch 9, Sec 2, [3.3.4] as applicable for **CLEANSHIP SUPER** notation
- Garbage waste records, in accordance with Ch 9, Sec 2, [2.4.8]
- For units fitted with a exhaust gas cleaning system, the washwater discharge records, in accordance with IMO Resolution MEPC259(68) Article 10.

**11.3.2** Such information is to be made available to the Surveyor of the Society upon request.

## SECTION 4

## ONBOARD SURVEYS

### 1 Application

#### 1.1

**1.1.1** Survey requirements for the additional class notations **CLEANSHIP**, **CLEANSHIP SUPER** and other additional class notations listed in Ch 9, Sec 1, Tab 1 are given in Pt A, Ch 5, Sec 7.

This Section contains additional requirements applying to the additional class notations **CLEANSHIP**, **CLEANSHIP SUPER**, **AWT-A**, **AWT-B** and **AWT-A/B**.

### 2 Periodical tests and measurements done by the shipowner

#### 2.1 General

##### 2.1.1 Purpose

The following tests and measurements, done under the responsibility of the shipowner, are intended to demonstrate the effective implementation of the waste management procedures and the constant level over time kept by the quality of the effluents discharged at sea.

#### 2.2 Initial period

##### 2.2.1 Initial tests

During the first year of commercial operation, the Shipowner is to proceed with the following measurements and analyses:

- collection of actual shipboard data's concerning the volume of wastes generation, using the waste streams as defined in Ch 9, Sec 2, Tab 2
- analyses of the effluent and waste streams for pollutant concentration, according to the periodicity defined in Tab 1.

**Table 1 : Frequency of analyses of waste streams during the first year of service**

Waste stream	Frequency of analyses
Metals analyses in incinerator ash (1)	quarterly
Metals analyses in grey water	quarterly
Effluent analyses sewage treatment plan	yearly
Effluent analyses for Advanced Wastewater Treatment (2)	quarterly
(1) If the ship is equipped to dump incinerator ash overboard.	
(2) Applies only to ships having the additional class notation <b>AWT-A</b> , <b>AWT-B</b> or <b>AWT-A/B</b>	

### 2.3 Periodical tests after first year of service

#### 2.3.1 General

The effluents and wastes usually discharged to sea are to be periodically sampled and analysed by a qualified laboratory. The frequency of these tests in a five-year term period is specified in Tab 2.

Tab 3 lists the number of occurrences where the pollutant maximum concentration may exceed the limit concentration specified in Tab 4 and Tab 5, without exceeding the reject value.

Test results of the measurements are to be recorded in the wastewater and garbage logbooks and made available to the surveyor during the periodical surveys.

#### 2.3.2 Water effluent standard

The effluent standard for biological analyses of waters are given in Tab 4.

#### 2.3.3 Metals analyses

The analyses given in Tab 5 are to qualify the incinerator ash and grey water as free from hazardous wastes. The metals listed in Tab 5 are considered as indicators of toxicity.

**Table 2 : Frequency of analyses of waste streams after the first year of service**

Waste stream	Number of analyses in a 5-year period
Metals analyses in incinerator ash (1)	2
Metals analyses in grey water	2
Effluent analyses sewage treatment plan	2
Effluent analyses for Advanced Wastewater Treatment (2)	20
Oil content analyses of machinery bilge water	2
(1) If the ship is equipped to dump incinerator ash overboard.	
(2) Applies only to ships having the additional class notation <b>AWT-A</b> , <b>AWT-B</b> or <b>AWT-A/B</b>	

**Table 3 : Permissible number of analyses exceeding limit values**

Number of analyses in a 5-year period	Maximum number of analyses above limit
2-5	0
20	2

**Table 4 : Biological analyses standard for waters**

Water to be tested	Pollutant	Limit concentration	Reject value
Effluent of oil filtering equipment	Oil	15 ppm	–
Effluent of sewage treatment plant	Thermotolerant coliforms (TC)	100 TC/100 ml	–
	Total suspended solids (TSS)	35 mg/l	–
	5-day biochemical oxygen demand (BOD <sub>5</sub> ) (1)	25 mg/l	–
	Chemical oxygen demand (COD)	125 mg/l	–
Effluent of AWT unit (for ships having the additional class notation <b>AWT-A</b> , <b>AWT-B</b> or <b>AWT-A/B</b> )	5-day biochemical oxygen demand (BOD <sub>5</sub> ) (1)	25 mg/l	60 mg/l
	Chemical oxygen demand (COD)	125 mg/l	–
	Total residual chlorine (2)	7,5 µg/l	100 µg/l
	Thermotolerant coliforms (TC) (2)	14 TC/100 ml	40 TC/100 ml
	Total suspended solids (TSS) (2)	30 mg/l	150 mg/l
	Total nitrogen (3)	20 mg/l	–
	Total phosphorus (3)	1.0 mg/l	–
(1) BOD <sub>5</sub> is the amount, in milligrams per litre, of oxygen used in the biochemical oxidation of organic matter in five days at 20°C.			
(2) Only for the notations <b>AWT-A</b> and <b>AWT-A/B</b>			
(3) Only for the notations <b>AWT-B</b> and <b>AWT-A/B</b>			

**Table 5 : Detection of heavy metals in ashes and water**

Metal	Limit concentration (ppm)
Arsenic	0,3
Barium	4,0
Cadmium	0,3
Chromium	5,0
Lead	1,5
Mercury	0,01
Selenium	0,3
Silver	0,2

### 3 Periodical surveys

#### 3.1 Initial survey

##### 3.1.1 Tests

After installation on board, the equipment and systems relevant to the requirements of the present Chapter are to be tested in the presence of the Surveyor under operating conditions. The control, monitoring and alarm systems are also to be tested in the presence of the Surveyor or their functioning is to be simulated according to a procedure agreed with the Society.

#### 3.2 Periodical survey

**3.2.1** The annual and class renewal surveys are to be carried out in accordance with the provisions of Pt A, Ch 5, Sec 7, [2].





# PROTECTION AGAINST CHEMICAL, BIOLOGICAL, RADIOLOGICAL AND NUCLEAR RISK

---

- SECTION 1      GENERAL**
- SECTION 2      SHIP ARRANGEMENT**
- SECTION 3      CBRN PROTECTION**
- SECTION 4      PIPING AND ELECTRICAL EQUIPMENT**
- SECTION 5      PRE-WETTING AND WASHDOWN SYSTEM**
- SECTION 6      INSPECTION AND TESTING**



# SECTION 1 GENERAL

## 1 General

### 1.1 Scope

**1.1.1** The present chapter details requirements for the protection of personnel onboard civilian ships intended for operation in atmospheres contaminated by chemical, biological, radiological or nuclear hazardous material (CBRN) for rescue or damage control purposes.

However, these requirements do not cover:

- operation in explosive atmosphere
- the risks associated to the explosion, shock, etc. that may result in CBRN pollution. Especially, this note does not cover exposure to a nuclear explosion and its immediate aftermath.

### 1.2 Application

**1.2.1** The following additional class notations **CBRN** or **CBRN-WASH DOWN** may be assigned, in accordance with Pt A, Ch 1, Sec 2 [6.14.40], to ships equipped in order to permit safe operation in CBRN conditions and complying with the requirements of the present note, as detailed below:

- The additional class notation **CBRN** is assigned to ships where a citadel with a collective protection system can be established, in order to effectively protect people inside from contamination.

Ships assigned with the additional class notation **CBRN** are to comply with the requirements of the present chapter except those of Ch 10, Sec 5 and of Ch 10, Sec 6, [1.5].

- The additional class notation **CBRN-WASH DOWN** is assigned to ships which, in addition to the above features, are provided with a wash-down system, in order to give increased protection during CBRN operations and allow immediate primary decontamination of the superstructures.

Ships assigned with the additional class notation **CBRN-WASH DOWN** are to comply with all the requirements of the present chapter.

### 1.3 CBRN operation specification

**1.3.1** It is the responsibility of the owner to detail the range of CBRN threats to be covered in order to enable efficient protection. The following information is to be clearly stated as a basis for design and in-service follow-up:

- CBRN agents to be considered (list of chemical or bacteriological agents to be considered, whether nuclear pollution is to be covered)
- Nature of operations to be carried out in the polluted area (e.g. personnel rescue, pollution control / cleanup,

coordination etc.). Specific spaces and systems related to these operations that need to be operable during CBRN operation are to be listed.

- Maximum duration for such operations
- Number of persons on board during operation (intervention personnel and rescued people).

## 2 Definitions and abbreviations

### 2.1 Citadel

**2.1.1** Space or group of spaces protected by overpressure and filtrated air ventilation system.

### 2.2 CBRN

**2.2.1** CBRN (Chemical, Biological, Radiological and Nuclear) refers to noxious chemical or biological agents or from nuclear fallouts, or to hazards resulting from their release.

Note 1: CBRN is also known as NBC (Nuclear, Biological and Chemical)

### 2.3 CBRN Mode

**2.3.1** Activation of the CBRN mode provides a contamination-free area in the citadel. CBRN mode needs to be defined for the following systems:

- Monitoring, control and alarm systems
- CBRN detection system
- Collective protection system
- Pre-wetting and wash down system on ships assigned with the additional class notation **CBRN-WASH DOWN**.

### 2.4 CBRN Operation

**2.4.1** Ship operation in an environment where CBRN hazard is expected. During CBRN operation, the citadel and the collective protection system are to be switched to CBRN mode.

### 2.5 Collective protection system

**2.5.1** The collective protection system is the ventilation system that provides a contamination-free environment in the citadel by:

- Keeping the citadel at an overpressure with respect to the atmosphere and,
- Providing clean air inside the citadel.

### 2.6 Shelter

**2.6.1** Space or group of spaces that can be made gastight.

## 2.7 PPE

**2.7.1** A set of personal protective equipment (PPE) is to consist of the elements listed in Ch 10, Sec 3, [3.1.2].

## 3 Documents to be submitted

### 3.1

**3.1.1** Documents to be submitted are listed in Tab 1.

**Table 1 : Documentation to be submitted**

No	I/ A (1)	Documents to be submitted
1	I	CBRN operation specification
2	I	CBRN operation manual
3	I	Citadel and shelter general arrangement
4	A	Citadel, airlock and cleansing station ventilation drawing, system details and sizing calculation
5	I	Engine room general arrangement
6	A	Details of engine air supply and engine casing
7	A	Details of door arrangement, control and monitoring
8	A	CBRN detection drawing and system details
9	A	Electrical equipment certificates
10	A	Diagram of the scupper and sanitary discharge system
11	A	For ships assigned with the additional class notation <b>CBRN-WASH DOWN</b> : Pre-wetting and wash-down system drawing, system details and sizing calculation
12	I	Procedures in case of fire during CBRN operation
(1) A: To be submitted for approval, I: To be submitted for information		

## SECTION 2

## SHIP ARRANGEMENT

### 1 Citadel

#### 1.1 Spaces to be included in the citadel

**1.1.1** The ship is to be provided with a citadel covering all enclosed spaces that may need to be accessed during CBRN operation, as defined in the CBRN operation specification.

**1.1.2** The citadel is to include at least all accommodation spaces and normally manned control stations, galleys and pantries, any space dedicated to the storage of food, and normally manned machinery spaces.

Note 1: See Article [7] for machinery space arrangement, especially engine room.

#### 1.2 Spaces where explosive atmosphere may occur

**1.2.1** In case spaces where an explosive atmosphere may occur, such as ro-ro or vehicle spaces, paint store, battery room or other spaces as relevant, need to be covered by the collective protection system, they are to be provided with CBRN ventilation systems completely separated from the CBRN ventilation system serving the rest of the citadel.

#### 1.3 Boundaries of the citadel

**1.3.1** Steps and recesses in the outer boundary of the citadel are to be kept to a minimum.

**1.3.2** All boundaries of the citadel are to be gastight.

#### 1.4 Openings in the citadel boundaries

**1.4.1** All openings in the citadel boundaries, except air supply ducts directly led to engines enclosed in a gastight enclosure, are to be able to be made gastight by automatic or manual operation locally and from the CBRN control station as defined in Article [2].

**1.4.2** Hold-back hooks not subject to release from the CBRN control station are not to be provided on doors in citadel boundaries.

**1.4.3** Indication is to be provided in the CBRN control station whether each opening in the citadel boundary is open or closed.

**1.4.4** Windows in the citadel boundary are to be gastight and of the non-opening type.

#### 1.5 Means of access to the citadel

**1.5.1** As a minimum, access and egress to and from the citadel is to be possible through:

- One cleansing station and its associated airlock complying with the requirements of Article [6] for access and/or egress during CBRN operation, and
- One airlock, separate from the airlock between the cleansing station and the citadel, complying with the requirements of Article [5] for egress during CBRN operations.

**1.5.2** As far as practicable, the airlocks and cleansing stations provided for access to and egress from the citadel are also to be the main and secondary escape routes from the citadel.

### 2 CBRN Control station

#### 2.1 Function

**2.1.1** All monitoring and control functions relevant for CBRN operation are to be available at the CBRN control station. Ch 10, Sec 3, Tab 2 lists monitoring and control functions required at the CBRN control station.

#### 2.2 Location

**2.2.1** The CBRN control station may be included in the navigation bridge or operation control room or located in a dedicated room.

### 3 Space for rescued people

#### 3.1 Accommodation for rescued people

**3.1.1** When rescuing of people is part of the ship's CBRN operation specification, a dedicated space is to be available as accommodation for rescued people. This space is to be included in the citadel and provided with suitable ventilation, lighting and sanitary facilities.

**3.1.2** Spaces for rescued people may be used for other purposes when the ship is not in CBRN rescuing operation. However, rescued people are not to be accommodated in the radio room, the wheelhouse or the CBRN control station and main access passageways which are to be kept clear.

#### 3.2 Means of escape

**3.2.1** Spaces for rescued people are to be provided with means of escape in line with the applicable requirements of Pt C, Ch 4, Sec 8.

## 4 Shelter

### 4.1 Sheltered spaces

**4.1.1** As far as practicable, any enclosed space that is not part of the citadel – i.e. not protected by overpressure ventilation – is to be capable of being made gastight for the whole duration of the CBRN operation.

**4.1.2** Sheltered spaces are to be provided with suitable means of cooling in order to maintain a temperature allowing proper functioning of the equipment installed therein during CBRN operation.

### 4.2 Openings in shelter boundary

**4.2.1** Any opening in the boundaries of such shelter is to comply with the requirements of [1.4].

## 5 Airlock

### 5.1 Arrangement

**5.1.1** Airlocks are to have a simple rectangular shape with two doors not less than 1 m apart.

**5.1.2** Airlocks are to be enclosed by gastight walls and doors.

### 5.2 Doors

**5.2.1** Airlock doors are to be provided with sills at least 300mm high.

**5.2.2** Airlock doors are to be self-closing doors.

**5.2.3** Airlock doors are to be wide enough to allow the passage of personnel wearing PPE.

**5.2.4** Means are to be provided to guarantee that only one door may be opened at a time during CBRN operation. An alarm is to be provided at the CBRN control station in case more than one of the doors is not fully closed.

### 5.3 Purging

**5.3.1** The doors of airlocks are to be provided with suitable interlocks to ensure airlock purging immediately after the door leading to the open deck or to the cleansing station has been opened. The other door leading to the citadel is to remain closed during purging.

**5.3.2** Airlock purging is to consist of at least 5 air changes. Attention is to be paid to possible air pockets and toxic gases accumulation, considering actual airflow.

## 6 Cleansing station

### 6.1 Arrangement

**6.1.1** A shower is to be arranged immediately outside the cleansing station for initial decontamination before entering the cleansing station.

**6.1.2** Cleansing stations are to be so arranged as to allow total undressing of potentially contaminated personnel and undressing of PPE, decontamination of personnel and containment and cleaning of contaminated PPE or clothing.

**6.1.3** Cleansing stations are to have a simple rectangular shape

**6.1.4** Access from the cleansing station to the citadel is to be through an airlock complying with the requirements of Article [5].

**6.1.5** The cleansing station and its associated airlock are to be sized to allow the entry and decontamination of personnel carrying a stretcher with a casualty and relevant medical equipment.

**6.1.6** Cleansing stations are to be enclosed by gastight walls and doors.

### 6.2 Doors

**6.2.1** Cleansing station doors are to be self-closing doors without any fixing device.

**6.2.2** Means are to be provided to guarantee that only one door can be opened at a time during CBRN operation. An alarm should be provided at the CBRN control station in case more than one of the doors is not fully closed.

## 7 Machinery space arrangement

### 7.1 Allowable arrangements for engine room and internal combustion machinery spaces

**7.1.1** The requirements of [7.1.2] to [7.1.5] are applicable to engine rooms and to all machinery spaces containing internal combustion machinery that is required to remain operational during CBRN operation. For ease of reading, such machinery spaces are called “engine room” in the following requirements.

**7.1.2** Depending on the ship operating range and CBRN operation philosophy, the engine room may be:

- included in the citadel, i.e. ventilated with decontaminated air and maintained in overpressure with respect to the atmosphere, or
- sheltered, i.e. able to be closed gastight, or
- unprotected.

**7.1.3** If the engine room is included in the citadel, the requirements of [7.2] are to be applied, together with all requirements applicable to spaces in the citadel.

**7.1.4** If the engine room is sheltered:

- The ship is to have the additional class notation **AUT-UMS** as defined in Pt A, Ch 1, Sec 2, [6.4.2] and Ch 3, Sec 1, and
- The requirements of [7.3] are to be applied.

**7.1.5** Unprotected engine room may be acceptable considering the specified CBRN operation scope and provided:

- The ship has the additional class notation **AUT-UMS** as defined in Pt A, Ch 1, Sec 2, [6.4.2] and Ch 3, Sec 1, and
- All accesses and means of escape are sized so as to allow for easy passage of personnel wearing PPE, and
- Relevant measures are taken to limit contamination and ease cleaning after CBRN operation, see especially [8.1], and
- The requirements of [7.4] are complied with.

## 7.2 Machinery space included in the citadel

### 7.2.1 Access

Access from a machinery space included in the citadel to other spaces in the citadel and reverse is to be through an airlock complying with the requirements of Article [5].

### 7.2.2 Air supply

Internal combustion machinery required to remain operational may be:

- either enclosed in a gastight enclosure and provided with a dedicated ducted air supply. Then the requirements of [7.2.3] are to be applied.
- or directly supplied by air from the engine room. Then the requirements of [7.2.4] are to be applied.

### 7.2.3 Engine with dedicated air supply

- a) The engine is to be enclosed in a gastight enclosure and provided with a dedicated air supply duct.
- b) Engine supply and exhaust air ducts are to be gastight.
- c) Engines with gastight design may be accepted as an alternative to gastight enclosure around the engine.
- d) The engine enclosure is to be maintained at a pressure below ambient pressure in the engine room. The differential pressure between the engine room and the enclosure is to be at least 0,5 mbar.

### 7.2.4 Engine supplied by air from the engine room

In case no dedicated air inlet duct is provided for the engine:

- air supply for the engine is to be taken into account in the sizing of the ventilation system serving the engine room during CBRN operation, and
- the engine exhaust air duct is to be gastight.

## 7.3 Sheltered machinery space

**7.3.1** Sheltered machinery spaces are to comply with the provisions of Article [4].

**7.3.2** Access from a sheltered machinery space to the citadel is to be through an airlock complying with the requirements of Article [5].

**7.3.3** The engine is to be gastight or enclosed in a gastight enclosure and provided with a dedicated ducted air supply, in line with the requirements of [7.2.3], items a) to c).

## 7.4 Unprotected machinery space

**7.4.1** Access from an unprotected machinery space to the citadel or to any sheltered space is to be through a cleansing station and associated airlock, complying with the requirements of Article [6].

**7.4.2** In addition, access from the citadel or from a sheltered space to an unprotected machinery space may be provided through an airlock complying with the requirements of Article [5].

**7.4.3** All accesses, stairways and passageways in unprotected machinery spaces are to be sized so as to allow the passage of personnel wearing PPE.

## 7.5 Fire protection

**7.5.1** Machinery spaces which are not permanently manned during CBRN operation are to be provided with a fixed fire detection and alarm system complying with the requirements of Pt C, Ch 4, Sec 15, [8].

**7.5.2** Machinery spaces located out of the citadel are to be provided with a fixed fire extinguishing system complying with the relevant requirements of Pt C, Ch 4, Sec 15.

**7.5.3** In case the engine is enclosed in a gastight enclosure, the enclosure is to be provided with a fixed fire detection and alarm system and with a fixed fire extinguishing system suitable for category A machinery spaces and complying with the relevant requirements of Pt C, Ch 4, Sec 15.

## 7.6 Engine room cooling

**7.6.1** Adequate cooling is to be provided in the engine room in order to keep the temperature at an acceptable level for personnel and to maintain safe equipment operation during CBRN operation.

# 8 Superstructure design

## 8.1 Precautions for decontamination

**8.1.1** The shape of external decks and superstructures is to be such as to avoid local accumulation of water.

**8.1.2** Surfaces that may be exposed to CBRN agents are to be made of easily decontaminable materials. This includes exposed interior surfaces in airlocks and cleansing stations and unprotected spaces, as well as external surfaces.

## **9 Marking**

### **9.1 Openings**

**9.1.1** All openings in the citadel and shelter boundaries are to be prominently marked. The marking is to indicate clearly (e.g. with a color code) in which situation the concerned opening may or may not be open.

### **9.2 Equipment**

**9.2.1** Equipment the setting of which needs to be modified for entering CBRN mode is to be prominently marked. The marking is to indicate clearly the relevant setting for each situation (CBRN operation or standard operation).



## SECTION 3

## CBRN PROTECTION

### 1 Detection system

#### 1.1 Detection

**1.1.1** The ship is to be provided with a fixed CBRN detection system adapted to the CBRN agents to be considered as per the CBRN operation specification.

**1.1.2** Detectors are to be provided as detailed in Tab 1:

- Inside the citadel: detectors are to be located close to potential contamination locations i.e. CBRN protection plant, airlock and cleansing stations, engine air supply.
- At the seawater suction pipe.
- Outside the citadel in the open air and in the sea water.

**1.1.3** Detectors are to be of a type approved by the Society.

#### 1.2 Alarm and monitoring

**1.2.1** An audible and visual alarm is to be provided at the navigating bridge and at the CBRN control station in case CBRN contamination is detected. The alarms are to be distinct depending on the detected hazard.

**1.2.2** For each hazard, the detected agent and measured value is to be displayed at the CBRN control station.

**1.2.3** An alarm is to be provided throughout the citadel in case CBRN contamination is detected inside the citadel. The criterion for triggering an alarm in the whole citadel may be higher than that for triggering alarm at the navigating bridge and CBRN control station, e.g. higher measured value, time delay or number of detectors impacted, to the satisfaction of the Society.

### 2 Collective Protection system

#### 2.1 Citadel ventilation

**2.1.1** The citadel is to be provided with a dedicated ventilation system, which does not serve any other space not included in the citadel.

**2.1.2** The citadel ventilation system is to be capable of maintaining an overpressure of 5 mbar relative to atmospheric pressure in all spaces within the citadel, except as specified in [2.2.1].

**2.1.3** Means of monitoring the overpressure in the citadel are to be provided and an alarm is to be provided at the CBRN control station in case the overpressure drops below the required minimum level.

**2.1.4** The ventilation system is to be sized so as to provide breathable air in the whole citadel during the expected duration of CBRN operation. The maximum number of people on board is to be taken into account for this purpose as well as the air consumption of any equipment located in the citadel and which may need to be used during CBRN operation. Especially, in case a machinery space included in the citadel contains a non-enclosed internal combustion machinery, air supply for this equipment is to be taken into account as required by Ch 10, Sec 2, [7.2.4].

Note 1: Expected leakages through citadel boundaries, including sealed openings, are to be considered.

**2.1.5** The sizing of the ventilation system is to be documented in a detailed calculation supported by a drawing showing air flowrates and pressure levels in each part of the citadel.

**2.1.6** Ventilation fans are to be located downstream of the CBRN filters.

**2.1.7** Exhaust air from the citadel may be used for the ventilation of:

- Other spaces in the citadel, including machinery spaces included in the citadel, or
- Airlocks, or
- Cleansing stations.

**2.1.8** As a rule, suitable non-return devices are to be fitted on ventilation ducts in order to maintain the required overpressure in the protected spaces and to prevent air flow from outside or decontamination spaces towards protected spaces or from machinery spaces towards other spaces.

**2.1.9** Parts of the ventilation system not fully complying with the requirements of Pt C, Ch 4, Sec 5, [6] may be accepted provided that:

- They are used solely during CBRN operation, and suitably marked to this end, and
- They are separated from parts of the ventilation system that will be used during normal operation, to the satisfaction of the Society, and
- The ventilation system in use during normal operation is fully compliant with the requirements of Pt C, Ch 4, Sec 5, [6]
- Suitable arrangements are provided to prevent the fire extinguishing medium, especially CO<sub>2</sub>, from leaving the protected space in case of release during CBRN operation or normal operation.

**2.1.10** Ventilation inlets for the citadel are to be widely separated from any ventilation outlets.

**Table 1 : Minimum number and location of CBRN detectors**

		Location			
		In the citadel	Seawater suction pipe	Open air	Sea water
Hazard	Radioactivity	1	1	1	1
	Chemical agents	1	–	2	–
	Biological agents	To be agreed depending on concerned biological agent			

## 2.2 Ventilation of machinery spaces included in the citadel

**2.2.1** The ventilation system for machinery spaces included in the citadel is to be capable of maintaining an overpressure of 4 mbar with respect to the atmospheric pressure. Machinery spaces included in the citadel are to remain at an underpressure of at least 1 mbar with respect to other spaces included in the citadel.

**2.2.2** During CBRN operation, machinery spaces included in the citadel may be ventilated with exhaust air from other spaces in the citadel, subject to the provisions of [2.1.9] and provided that:

- The levels of CO<sub>2</sub> and oxygen remain acceptable for personnel to work in the space without breathing apparatus, and
- Suitable non-return valves are fitted in the ventilation ducts in order to maintain the differential pressure between machinery spaces and other spaces included in the citadel.

## 2.3 CBRN Protection plant

**2.3.1** The CBRN protection plant is to include gas and particulate filters capable of efficiently removing all CBRN agents listed in the CBRN operation specification:

- The CBRN gas filters are to be type-approved activated carbon filters capable of eliminating chemical agents and other gases.
- The CBRN particulate filters are to be type-approved high efficiency particulate air (HEPA) filters realizing a collection efficiency H13 according to EN 1822-1 or a collection efficiency of 99.97% of particles of 0,3 µm or greater.

**2.3.2** The air inlet for the protection plant is to be provided with suitable devices to prevent water, moisture, particulate and corrosive marine salts from entering the CBRN filtration system. In addition, suitable pre-filters are to be provided so that the quality and humidity content of the air blown on the CBRN filter is in line with manufacturer's specification.

**2.3.3** Filters are to be easy to change.

**2.3.4** A damper is to be installed downstream of the CBRN filters. This damper is to be interlocked with the inlet fan and open only when the inlet fan is working and blowing air towards the citadel.

## 2.4 Airlocks and cleansing stations

**2.4.1** Airlocks and cleansing stations are to be provided with a mechanical ventilation capable of providing at least 30 air changes per hour.

**2.4.2** Airlocks and cleansing stations are to be supplied with decontaminated air. Exhaust air from the citadel may be used for this purpose, provided suitable non-return devices are installed as relevant.

**2.4.3** Exhaust air from an airlock may be used as supply for the associated cleansing station, provided suitable non-return devices are installed as relevant.

**2.4.4** Ventilation exhausts from airlocks are to be led to the associated cleansing station or to the open deck. Ventilation exhausts from cleansing stations are to be led to the open deck and provided with suitable non-return devices as necessary to avoid airflow from the outside towards inside the airlock.

## 3 Personal protective equipment (PPE)

### 3.1 General

**3.1.1** A sufficient number of complete sets of protective equipment is to be carried on board, according to the scope defined in the CBRN operation specification.

**3.1.2** A set of protective equipment is to consist of:

- CBRN suit
- CBRN gloves and shoes
- Self-contained breathing apparatus with adequate CBRN mask.

In addition, prophylactic kits adapted to the risks expected according to the CBRN operation specification are to be provided as relevant.

### 3.2 Self-contained breathing apparatus

**3.2.1** The ship is to be equipped with a high pressure air compressor complete with all fittings necessary for refilling the bottles of air breathing apparatuses.

**3.2.2** The capacity of the air compressor is to be sufficient to allow the refilling of all the bottles of air breathing apparatuses in no more than 30 min.

**3.2.3** It is to be possible to supply the air compressor with clean air from the citadel.

**3.2.4** In case the main air intake for the compressor is located outside of the citadel, suitable interlock with the CBRN detection system is to be provided to avoid contamination of the breathable air system.

**3.2.5** Air supply for the air compressor is to be taken into account for the sizing of the citadel ventilation system.

## 4 Monitoring and Controls

### 4.1

4.1.1 All monitoring and control equipment relevant for CBRN operation are to be provided at the CBRN control station.

4.1.2 Tab 2 summarizes monitoring and control requirements for CBRN systems.

## 5 Onboard procedures

### 5.1 CBRN operation manual

5.1.1 The CBRN operation manual is to include:

- The CBRN operation specification
- A plan showing the citadel, space for rescued people, shelter, airlock and cleansing stations arrangement
- A plan showing all gastight closing appliances that need to be closed prior to CBRN operation, together with a detailed description of this system
- A detailed description of the detection system required in [1] with relevant drawings, operating instructions and alarm codes for the CBRN detection system
- A detailed description and drawings of the citadel ventilation system. Parts of the system to be used solely for CBRN operation are to be outlined
- Detailed procedure for switching to CBRN mode including:
  - Closure of all openings
  - Modifications of the ventilation system if relevant
  - CBRN filter activation
- Measures to be taken in case of alarm related to the CBRN system (e.g. loss of overpressure)
- Measures to be taken in case of fire during CBRN operation

**Table 2 : Summary of monitoring and control requirements for CBRN systems (during CBRN operation)**

System	Indication	Alarm	Control
<b>CBRN detection system</b>			
• CBRN contamination detection outside (1)	CBRN control station	Audible and visual alarm: <ul style="list-style-type: none"> <li>• Navigating bridge</li> <li>• CBRN control station</li> </ul>	CBRN control station
• CBRN contamination detection in the citadel (1)	CBRN control station	Audible and visual alarm: <ul style="list-style-type: none"> <li>• Navigating bridge</li> <li>• CBRN control station</li> <li>• Throughout the citadel</li> </ul>	CBRN control station
<b>CBRN collective protection ventilation system</b>			
• Differential pressure between citadel and atmosphere (2)	CBRN control station	CBRN control station	
• Differential pressure between machinery space and other spaces in the citadel (2)	CBRN control station	CBRN control station	
• Differential pressure between enclosed engine casing and machinery space (2)	CBRN control station	CBRN control station	
• Differential pressure between machinery space and atmosphere (2)	CBRN control station	CBRN control station	
• Position of gastight closing appliances in the citadel and shelter boundaries (3)	CBRN control station	–	Local and remote at the CBRN Control station
• Airlock and cleansing station doors (4)	CBRN control station	Alarm at the CBRN control station in case more than one door is open	
• Isolation valves in piping system (5)	CBRN control station	–	Local and remote, inside the citadel
<b>Pre-wetting and washdown system</b>			
• Pump (6)	CBRN control station	–	Local and remote from the CBRN control station
• Section valves (6)	CBRN control station	–	Local and remote from the CBRN control station
(1) See [1.2] (2) See [2.1.3] (3) See Ch 10, Sec 2, [1.4.3] and Ch 10, Sec 2, [1.4.1] (4) See Ch 10, Sec 2, [5.2.4] and Ch 10, Sec 2, [6.2.2] (5) See Ch 10, Sec 4, [1.1.2] (6) See Ch 10, Sec 5, [2.2.2]			

## 5.2 Fire control plan

5.2.1 The following information is to be clearly shown on the fire control plan:

- Citadel and/or shelter
- Storage location of personal protective equipment
- CBRN detection system

- Pre-wetting and wash down system and associated control valves for ships assigned with the additional class notation **CBRN-WASH DOWN**.

## 5.3 Fire procedures

5.3.1 Procedures in case of fire during CBRN operation are to be defined and submitted for information.

## SECTION 4

## PIPING AND ELECTRICAL EQUIPMENT

### 1 Piping systems

#### 1.1 General

**1.1.1** Piping systems not serving the citadel are not to pass through the citadel.

**1.1.2** In general, separate piping systems are to be provided to serve:

- the citadel
- shelters, if any
- airlocks and cleansing stations
- other unprotected spaces.

On case by case basis, the Society may accept other arrangements if needed for operational reasons, provided suitable isolation valves are fitted. These valves are to be operable locally and remotely from inside the citadel. Indication of their position is to be provided at the CBRN control station, and they are to be marked in line with the requirements of Ch 10, Sec 2, [9].

**1.1.3** Sea suction serving the fire main, decontamination showers, cooling systems, and pre-wetting and wash down system where provided, are to be located as low as possible.

#### 1.2 Scupper and bilge systems

**1.2.1** Separate scupper and bilge systems are to be provided for:

- The citadel
- Shelters, if any
- Airlocks and cleansing stations
- Other unprotected spaces.

**1.2.2** Scupper and bilge systems are to be sized taking into account decontamination systems, i.e. decontamination shower in cleansing stations and wash down system on ships assigned with the additional class notation **CBRN-WASH DOWN**.

**1.2.3** Drainage from the cleansing stations and external decontamination shower are to be led directly overboard.

**1.2.4** Scuppers from spaces within the citadel or the shelter, and from airlocks and cleansing stations are to be fitted with adequate devices, such as water traps, that will preserve the required overpressure in the protected spaces and prevent the ingress of external air.

**1.2.5** Separate scupper and bilge systems are to be provided for spaces that are maintained at different overpressure during CBRN operation.

#### 1.3 Air, sounding and overflow pipes

**1.3.1** The potable water tank venting is to be led inside the citadel.

**1.3.2** Vent pipes and filling connections of service tanks are to be arranged so that hazardous material cannot enter the tanks during CBRN operation.

### 2 Electrical equipment

#### 2.1 Environmental protection

**2.1.1** Electrical equipment located in the citadel or shelter is to have environmental category (EC) at least EC 31 C or EC 33 C as applicable. Environmental categories are defined in Pt C, Ch 2, Sec 1, [3.28].

**2.1.2** If the local temperature around the equipment may be expected to rise above 55°C, specific testing may be required.

#### 2.2 Emergency source of power

**2.2.1** The following systems are to be supplied by the emergency source of power:

- Ventilation system for the citadel
- CBRN detection system
- Control and monitoring of openings in citadel boundaries.

## SECTION 5

## PRE-WETTING AND WASHDOWN SYSTEM

### 1 General

#### 1.1 Application

**1.1.1** This section applies to ships assigned with the additional class notation **CBRN-WASH DOWN**.

#### 1.2 Ventilation openings

**1.2.1** The ventilation openings are to be arranged so as to prevent water ingress in the ventilating ducts when the pre-wetting and wash down system is in use

### 2 Pre-wetting and washdown system

#### 2.1 System arrangement

**2.1.1** The ship is to be provided with a pre-wetting and wash down system capable of providing continuous and complete coverage of all external horizontal and vertical surfaces of superstructures and weather decks.

Any equipment installed on open deck is to be covered by this system.

**2.1.2** The capacity of the pre-wetting and wash down system is to be not less than 3 L/min for each square meter of protected area.

**2.1.3** Nozzles are to be so arranged that all parts of the protected surfaces can be covered by a moving film of water.

**2.1.4** The pre-wetting and wash-down system may be divided into sections capable of being operated independently.

#### 2.2 System equipment

**2.2.1** The pre-wetting and wash down system may share pumps and/or piping with other systems, including fire-fighting systems. In this case, the pump capacity is to be sufficient to supply either the pre-wetting and wash down system or the other system(s).

**2.2.2** The pump and section valves are to be capable of local and remote operation from the CBRN control station. Indication of each section valve open or close position is also to be provided at this location.

**2.2.3** Pipes, valves and nozzles are to be protected against corrosion and are to comply with the relevant requirements of Pt C, Ch 1, Sec 10.

**2.2.4** Suitable drainage cocks are to be arranged and precautions are to be taken in order to prevent clogging of the nozzles by impurities contained in pipes, nozzles, valves and pumps.

## SECTION 6

## INSPECTION AND TESTING

### 1 Construction testing

#### 1.1 General

**1.1.1** This article details acceptance tests to be carried out during ship commissioning. They may be carried out at yard or during sea trials.

**1.1.2** The provisions of [1.2] to [1.4] are applicable to ships with the additional class notation **CBRN** or **CBRN-WASH DOWN**.

The provisions of [1.5] are applicable only to ships with the additional class notation **CBRN-WASH DOWN**.

#### 1.2 Tightness test

**1.2.1** Remote closing of all openings in the citadel and shelter boundaries is to be tested, including doors, valves and ventilation openings, when supplied from the main source of power and when supplied from the emergency source of power.

**1.2.2** The citadel and shelter(s) are to be pressure-tested and checked for leakage once all openings have been closed.

For the pressure test, the citadel or shelter(s) are to be pressurized with all openings closed, and the air supply is to be isolated. It is then to be checked that the pressure can be maintained for 10min in the citadel or shelter.

#### 1.3 Collective protection ventilation test

**1.3.1** The collective protection ventilation system is to be tested upon building completion in order to demonstrate that the required overpressure can be maintained and that oxygen and temperature levels remain acceptable.

**1.3.2** The ventilation test duration is to be the minimum between:

- 24h, and
- The maximum duration for CBRN operation according to the CBRN operation specification.

This test is to be carried out with the ventilation system fed from the main power source. In addition, it is to be checked that the ventilation system functions properly when fed from the emergency power source.

**1.3.3** The number of people inside the citadel throughout the test is to be the maximum number of people onboard during CBRN operation according to the CBRN operation specification.

**1.3.4** The citadel overpressure is to remain within the required range during the whole test. This includes:

- Differential pressure between the citadel and the atmosphere
- Differential pressure between machinery spaces included in the citadel and the rest of the citadel, if applicable
- Differential pressure between engine enclosure and machinery spaces, if applicable.

**1.3.5** Oxygen and temperature levels are to remain acceptable during the whole test.

**1.3.6** Functioning control for airlock and cleansing stations is to be carried out with the collective protection ventilation system working.

#### 1.4 CBRN detection test

**1.4.1** A functioning test of the CBRN detection system is to be carried out. However, no actual contamination is to be used for the purpose of this test.

**1.4.2** Each line is to be tested from the level of the detector, with means defined by the system supplier.

#### 1.5 Pre-wetting and wash down test

**1.5.1** On ships assigned with the additional class notation **CBRN-WASH DOWN**, a functioning test of each section of the pre-wetting and wash down system is to be carried out.

**1.5.2** It is to be checked that all external surfaces are actually covered by a moving water film while the system is activated.

**1.5.3** Proper drainage of the water is to be checked. There should be no water accumulation on deck.

**1.5.4** Remote operation of each section valve is to be tested.





## OTHER ADDITIONAL CLASS NOTATIONS

---

<b>SECTION 1</b>	<b>STRENGTHENED BOTTOM (STRENGTHBOTTOM)</b>
<b>SECTION 2</b>	<b>GRAB LOADING (GRABLOADING)</b>
<b>SECTION 3</b>	<b>IN-WATER SURVEY ARRANGEMENTS (INWATERSURVEY)</b>
<b>SECTION 4</b>	<b>SINGLE POINT MOORING (SPM)</b>
<b>SECTION 5</b>	<b>CONTAINER LASHING EQUIPMENT (LASHING)</b>
<b>SECTION 6</b>	<b>DYNAMIC POSITIONING (DYNAPOS)</b>
<b>SECTION 7</b>	<b>VAPOUR CONTROL SYSTEM (VCS)</b>
<b>SECTION 8</b>	<b>COFFERDAM VENTILATION (COVENT)</b>
<b>SECTION 9</b>	<b>CENTRALISED CARGO AND BALLAST WATER HANDLING INSTALLATIONS (CARGOCONTROL)</b>
<b>SECTION 10</b>	<b>SHIP MANOEUVRABILITY (MANOVR)</b>
<b>SECTION 11</b>	<b>COLD WEATHER CONDITIONS</b>
<b>SECTION 12</b>	<b>EFFICIENT WASHING OF CARGO TANKS (EWCT)</b>
<b>SECTION 13</b>	<b>PROTECTED FO TANKS (PROTECTED FO TANKS)</b>
<b>SECTION 14</b>	<b>INCREASED ADMISSIBLE CARGO TANK PRESSURE (IATP)</b>
<b>SECTION 15</b>	<b>ENHANCED FIRE PROTECTION (EFP-AMC)</b>
<b>SECTION 16</b>	<b>SINGLEPASSLOADING</b>
<b>SECTION 17</b>	<b>BOW AND STERN LOADING / UNLOADING SYSTEMS</b>

<b>SECTION 18</b>	<b>SUPPLY AT SEA (SAS)</b>
<b>SECTION 19</b>	<b>PERMANENT MEANS OF ACCESS (ACCESS)</b>
<b>SECTION 20</b>	<b>HELIDECK (HEL)</b>
<b>SECTION 21</b>	<b>BATTERY SYSTEM</b>
<b>SECTION 22</b>	<b>ELECTRIC HYBRID</b>
<b>SECTION 23</b>	<b>UNSHELTERED ANCHORING</b>
<b>SECTION 24</b>	<b>SCRUBBER READY</b>
<b>SECTION 25</b>	<b>GAS-PREPARED SHIPS</b>
<b>SECTION 26</b>	<b>ULTRA-LOW EMISSION VESSEL (ULEV)</b>
<b>SECTION 27</b>	<b>MAN OVERBOARD DETECTION (MOB)</b>
<b>SECTION 28</b>	<b>HEADING CONTROL IN ADVERSE CONDITIONS</b>
<b>SECTION 29</b>	<b>ELECTRIC HYBRID PREPARED</b>
<b>SECTION 30</b>	<b>ENHANCED CARGO FIRE PROTECTION FOR CONTAINER SHIPS (ECFP)</b>
<b>SECTION 31</b>	<b>BIOLOGICAL RISK MANAGEMENT (BIORISK)</b>
<b>SECTION 32</b>	<b>HYBRID MECHANICAL PROPULSION</b>
<b>SECTION 33</b>	<b>OPEN-HATCH</b>
<b>SECTION 34</b>	<b>FSRU-READY</b>
<b>SECTION 35</b>	<b>AMMONIA-PREPARED SHIPS</b>
<b>SECTION 36</b>	<b>SUSTAINABLE SHIPS</b>

## SECTION 1

## STRENGTHENED BOTTOM (STRENGTHBOTTOM)

### Symbols

B	: Moulded breadth, in m, defined in Pt B, Ch 1, Sec 2, [3.4]
L	: Rule length, in m, defined in Pt B, Ch 1, Sec 2, [3.1]
$h_{DB}$	: Height, in m, of double bottom
$P_S, P_W$	: Still water and wave pressures as defined in Pt B, Ch 5, Sec 5 for upright ship conditions (load case "a") with positive $h_1$ These loads are to be considered as acting alone without any counteraction from ship internal pressure
$R_y$	: Minimum yield stress, in N/mm <sup>2</sup> , of the material, to be taken equal to 235/k N/mm <sup>2</sup> (the material factor k is defined in Pt B, Ch 4, Sec 1, [2.3])
$\gamma_m$	: Partial safety factor for material to be taken equal to: $\gamma_m = 1,02$
$\gamma_{S2}$	: Partial safety factor for still water pressure to be taken equal to: $\gamma_{S2} = 1,00$
$\gamma_{W2}$	: Partial safety factor for wave pressure to be taken equal to: $\gamma_{W2} = 1,20$
$\sigma_g$	: Hull girder normal stresses in stranded condition defined in [1.1.3]. For ships less than 90 m, $\sigma_g$ is to be taken equal to: $\sigma_g = 0$ .

### 1 General

#### 1.1 Application

**1.1.1** The additional class notation **STRENGTHBOTTOM** is assigned, in accordance with Pt A, Ch 1, Sec 2, [6.14.1], to ships built with specially strengthened bottom structures so as to be able to be loaded and/or unloaded when properly stranded and complying with the requirements of this Section.

**1.1.2** The assignment of additional class notation **STRENGTHBOTTOM** assumes that the ship will only be grounded on plane, soft and homogeneous sea beds with no rocks or hard points and in areas where the sea is calm such as harbours or sheltered bays.

**1.1.3** As a general rule, the requirements of this Section are applicable to ship having a length less than or equal to 90 m.

Ships greater than 90 m in length may be considered by the Society on a case-by-case basis, taking into account the specific hull girder loads induced by loading and unloading when stranded.

The general configuration of the ship and the conditions of grounding during loading and unloading operations having an effect on the hull girder loads are to be specified. The longitudinal distribution of bending moment is to be calculated, and the hull girder normal stresses,  $\sigma_g$ , for elements contributing to the hull girder longitudinal strength in stranded condition are to be calculated.

### 2 Primary supporting members arrangement

#### 2.1 Ships with a longitudinally framed bottom

**2.1.1** Solid floors and side girders are to be fitted with a maximum spacing between floors and girders not greater than  $0,9 L^{0,25}$ .

The number and size of holes on floors and girders are to be kept as small as possible, and are to be such as to allow complete inspection of double bottom structures.

#### 2.2 Ships with a transversely framed bottom

**2.2.1** Floors are to be fitted at every frame.

Side girders are to be fitted on each side of the ship with a maximum spacing not greater than  $0,9 L^{0,25}$ .

The number and size of holes on floors and girders are to be kept as small as possible, and are to be such as to allow complete inspection of double bottom structures.

### 3 Bottom scantlings

#### 3.1 Plating

##### 3.1.1 Plating

The net thickness of the bottom and bilge platings obtained from Pt B, Ch 7, Sec 1 or the thickness obtained from NR600, as applicable, are to be increased by 20% and in no case are to be less than 8 mm.

The values of the corrosion addition are to be taken as defined in Pt B, Ch 4, Sec 2, [3] for plating calculated according to Pt B, Ch 7, Sec 1.

#### 3.2 Ordinary stiffeners

**3.2.1** The net section modulus  $w$ , in cm<sup>3</sup>, and the net shear section area  $A_{Sh}$ , in cm<sup>2</sup>, of longitudinal or transverse bottom ordinary stiffeners are to be not less than the greater of the following values:

- the values obtained from Pt B, Ch 7, Sec 2 or NR600, as applicable

- the values obtained by the following formula:

$$w = \gamma_R \gamma_m \beta_b \frac{\gamma_{s2} P_s + \gamma_{w2} P_w}{12(0,65 R_y - \sigma_g)} s \ell^2 10^3$$

$$A_{sh} = 10 \gamma_R \gamma_m \beta_s \frac{\gamma_{s2} P_s + \gamma_{w2} P_w}{0,65 R_y} s \ell$$

where:

- $\ell$  : Span, in m, of ordinary stiffeners
- $s$  : Spacing, in m, of ordinary stiffeners
- $\gamma_R$  : Partial safety factor for resistance, to be taken equal to 1,25
- $\beta_b, \beta_s$  : Coefficients defined in Tab 1.

**Table 1 : Coefficients  $\beta_b$  and  $\beta_s$**

Brackets at ends	$\beta_b$	$\beta_s$
0	1	1
1	0,90	0,95
2	0,81	0,90

**Note 1:** The length of the brackets is to be not less than 0,1  $\ell$ .

### 3.3 Primary supporting members

**3.3.1** The net section modulus  $w$ , in  $\text{cm}^3$ , and the net shear section area  $A_{sh}$ , in  $\text{cm}^2$ , of longitudinal or transverse bottom primary supporting members are to be not less than the greater of the following values:

- the values obtained from Pt B, Ch 7, Sec 3 or NR600, as applicable
- the values obtained by the following formula:

$$w = \gamma_R \gamma_m \beta_b \frac{\gamma_{s2} P_s + \gamma_{w2} P_w}{12(0,65 R_y - \sigma_g)} s \ell^2 10^3$$

$$A_{sh} = 10 \gamma_R \gamma_m \beta_s \frac{\gamma_{s2} P_s + \gamma_{w2} P_w}{0,65 R_y} s \ell$$

where:

- $\ell$  : Span, in m, of primary supporting member
- $s$  : Spacing, in m, of primary supporting member
- $\gamma_R$  : Partial safety factor for resistance, to be taken equal to 1,4
- $\beta_b, \beta_s$  : Coefficients defined in Tab 1.

## SECTION 2

## GRAB LOADING (GRABLOADING)

### 1 General

#### 1.1 Application

**1.1.1** The additional class notation **GRABLOADING** is assigned, in accordance with Pt A, Ch 1, Sec 2, [6.14.2], to ships with holds specially reinforced for loading/unloading cargoes by means of buckets or grabs and complying with the requirements of this Section.

### 2 Scantlings

#### 2.1 Inner bottom plating

**2.1.1** The net thicknesses of:

- inner bottom plating, where no continuous wooden ceiling is fitted
- hopper tank sloped plate and transverse stools, if any, up to 1,5 m from the inner bottom

- bulkhead plating, if no stool is fitted, up to 1,5 m from the inner bottom,

is to be obtained, in mm, from the following formula:

$$t = t_1 + t_G$$

where:

- $t_1$  : Net thickness, in mm, to be obtained from Pt B, Ch 7, Sec 1 or NR600, as applicable
- $t_G$  : Additional net thickness for taking account of grab impacts, to be taken equal to 3,5 mm. For inner bottom plating, where no continuous wooden ceiling is fitted,  $t_G$  includes the 2 mm required in Pt B, Ch 7, Sec 1, [2.4.1] or NR600, as applicable.

Above 1,5 m from the inner bottom, the net thicknesses of the above plating may be tapered to those obtained from the formulae in Pt B, Ch 7, Sec 1 or NR600, as applicable. The tapering is to be gradual.

## SECTION 3

# IN-WATER SURVEY ARRANGEMENTS (INWATERSURVEY)

### 1 General

#### 1.1 Application

**1.1.1** The additional class notation **INWATERSURVEY** is assigned in accordance with Pt A, Ch 1, Sec 2, [6.14.3].

#### 1.2 Documentation to be submitted

##### 1.2.1 Plans

Detailed plans of the hull and hull attachments below the waterline are to be submitted to the Society for approval. These plans are to indicate the location and/or the general arrangement of:

- all shell openings
- the stem
- rudder and fittings
- the sternpost
- the propeller, including the means used for identifying each blade
- anodes, including securing arrangements
- bilge keels
- welded seams and butts
- marking as per [2.1] with type, position, size, paint, tank abbreviation table.

The plans are also to include the necessary instructions to facilitate the divers' work, especially for taking clearance measurements.

Moreover, a specific detailed plan showing the systems to be adopted when the ship is floating in order to assess the slack between pintles and gudgeons is to be submitted to the Society for approval.

##### 1.2.2 Photographs

As far as practicable, photographic documentation of the following hull parts, used as a reference during the in-water surveys, is to be submitted to the Society:

- the propeller boss
- rudder pintles, where slack is measured
- typical connections to the sea
- directional propellers, if any
- other details, as deemed necessary by the Society on a case-by-case basis.

##### 1.2.3 Documentation to be kept on board

The Owner is to keep on board the ship the plans and documents listed in [1.2.1] and [1.2.2], and they are to be made available to the Surveyor and the divers when an in-water survey is carried out.

### 2 Structure design principles

#### 2.1 Marking

**2.1.1** Identification marks and systems are to be supplied on the outer surface of the immersed shell to facilitate the in-water survey by showing clearly the positions of water-tight bulkheads.

**2.1.2** Markings are to be at least 300 mm long and 30 mm wide, and be made in high contrast colour and surrounded by weld bead. The use of antifouling paint is advised.

Anodes or external attachments on the hull may replace markings, provided they are identified accordingly on the plans submitted for approval according to [1.2.1].

**2.1.3** Every tank and bulkhead is to be clearly identified on the full immersed shell (side shells and bottom) by:

- at least one marking every five ordinary stiffeners spacing, distributed along the bulkhead length, without exceeding 5 m between two markings
- a segmented marking at every angle formed by a bulkhead
- a cross shaped marking at every bulkheads intersection
- the abbreviated name of each tank, to be painted beside one of the boundaries markings.

#### 2.2 Rudder arrangements

**2.2.1** Rudder arrangements are to be such that rudder pintle clearances and fastening arrangements can be checked.

#### 2.3 Tailshaft arrangements

**2.3.1** Tailshaft arrangements are to be such that clearances (or wear down by poker gauge) can be checked.

### 3 Sea inlets and cooling water systems of machinery

#### 3.1

**3.1.1** Means should be provided to enable the diver to confirm that the sea suction openings are clear. Hinged sea suction grids will facilitate this operation, preferably with revolving weight balance or with a counter weight, and secured with bolts practical for dismantling and fitting while the ship is afloat.

## SECTION 4

## SINGLE POINT MOORING (SPM)

### 1 General

#### 1.1 Application

**1.1.1** The additional class notation **SPM** is assigned in accordance with Pt A, Ch 1, Sec 2, [6.14.4] to ships fitted forward with equipment for mooring at single point mooring or single buoy mooring terminals, using standardised equipment complying with the recommendations of the Oil Companies International Marine Forum (OCIMF), according to the requirements of this Section.

**1.1.2** These requirements comply with and supplement the Recommendations for Equipment Employed in the Bow Mooring of Conventional Tankers at Single Point Moorings of the OCIMF (4-th edition - May 2007).

Note 1: Subject to Owner's agreement, applications for certification in compliance with the following previous editions of the OCIMF recommendations are examined by the Society on a case-by-case basis:

- 1st edition (1978): Standards for Equipment Employed in the Mooring of Ships at Single Points Moorings
- 2nd edition (1988): Recommendations for Equipment Employed in the Mooring of Ships at Single Point Moorings
- 3rd edition (1993): Recommendations for Equipment Employed in the Mooring of Ships at Single Point Moorings.

Note 2: The edition considered is specified in the certificate relating to the **SPM** notation.

**1.1.3** Some components of the equipment used for mooring at single point moorings may be common with the bow emergency towing arrangements specified in Pt B, Ch 9, Sec 4, [3], provided that the requirements of this Section and of Pt B, Ch 9, Sec 4, [3] are complied with.

**1.1.4** The relevant requirements of this Section may also be applied to ships fitted afterward with equipment for mooring at single point mooring or single buoy mooring terminals. In such a case, the additional class notation **SPM** is assigned by the Society on a case by case basis.

### 2 Documentation

#### 2.1 Documentation for approval

**2.1.1** In addition to the documents in Pt B, Ch 1, Sec 3, the following are to be submitted to the Society for approval:

- general layout of the forecastle arrangements and associated equipment
- constructional drawing of the bow chain stoppers, bow fairleads and pedestal roller fairleads, together with material specifications and relevant calculations
- drawings of the local ship structures supporting the loads applied to chain stoppers, fairleads, roller pedestals and winches or capstans.

#### 2.2 Documentation for information

**2.2.1** The following documentation is to be submitted to the Society for information (see Pt B, Ch 1, Sec 3):

- specifications of winches or capstans giving the continuous duty pull and brake holding force
- DWT, in t, of the ship at summer load line defined in Pt B, Ch 1, Sec 2, [3.9.1].

### 3 General arrangement

#### 3.1 General provision

**3.1.1** For mooring at SPM terminals ships are to be provided forward with equipment to allow for heaving on board a standardised chafing chain of 76 mm in diameter by means of a pick-up rope and to allow the chafing chain to be secured to a strongpoint.

**3.1.2** The strongpoint is to be a chain cable stopper.

#### 3.2 Typical layout

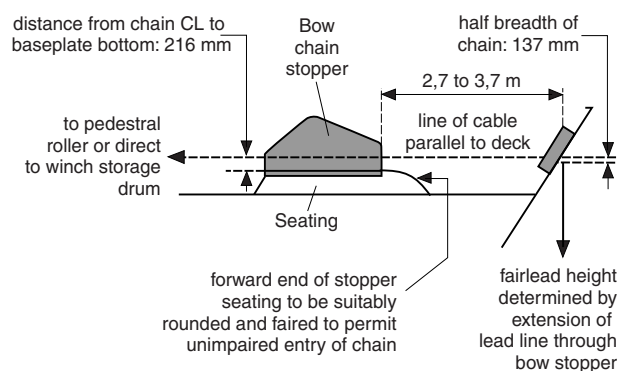
**3.2.1** Fig 1, Fig 2 and Fig 3 show the forecastle schematic layout of the ship which may be used as reference.

#### 3.3 Equipment

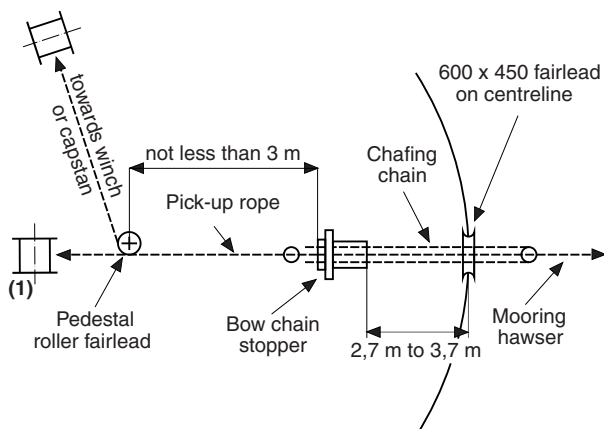
**3.3.1** The components of the ship's equipment required for mooring at single point moorings are the following:

- bow chain stopper, according to [5.1]
- bow fairlead, according to [5.2]
- pedestal roller fairlead, according to [5.3]
- winch or capstan, according to [5.4].

**Figure 1 : Typical forecastle schematic layout**

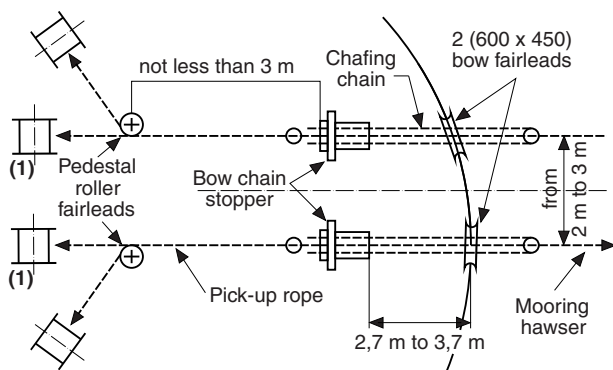


**Figure 2 : Forecastle schematic layout for DWT ≤ 150000 t**



(1) Winch storage drum without pedestal roller

**Figure 3 : Forecastle schematic layout for DWT > 150000 t**



(1) Winch storage drum without pedestal roller

## 4 Number and safe working load of chain stoppers

### 4.1 General

4.1.1 The number of chain stoppers and their safe working load (SWL), in kN, depending on the DWT of the ship, are defined in Tab 1.

**Table 1 : Number and SWL of chain stoppers**

Deadweight, in t	Chain stoppers	
	Number	Safe working load (SWL), in kN
DWT ≤ 100000	1	2000
100000 < DWT ≤ 150000	1	2500
DWT > 150000	2	3500

4.1.2 Although the required safe working load (SWL) is generally agreed by the SPM terminal operators, Owners and shipyards are advised that increased safe working load may be requested by terminal operators to take account of local environmental conditions.

In such case the Society is to be duly informed of the special safe working load to be considered.

## 5 Mooring components

### 5.1 Bow chain stopper

5.1.1 The ship is to be equipped with bow chain cable stoppers complying with the requirements in Tab 1 and designed to accept standard chafing chain of 76 mm in diameter.

Note 1: The chafing chains are made of:

- grade Q3 steel for ships of less than 350000 t DWT
- grade Q4 steel for ships of equal to or greater than 350000 t DWT.

However, chafing chains are supplied by the SPM terminal operators and are not required to be part of the ship's equipment.

5.1.2 The stoppers are to be capable of securing the 76 mm common stud links of the chain cable when the stopping device (chain engaging pawl or bar) is in the closed position and freely passing the chain cable and its associated fittings when the stopping device is in the open position.

5.1.3 Bow chain stoppers may be of the hinged bar or pawl (tongue) type or other equivalent design. Hydraulic bow chain stoppers with interlocks and emergency shut-down systems integral to the bow loading system are to be considered by the Society on a case-by case basis.

Typical arrangements of bow chain stoppers are shown in Fig 4.

5.1.4 The stopping device (chain engaging pawl or bar) of the chain stopper is to be arranged, when in the closed position, to prevent it from gradually working to the open position, which would release the chafing chain and allow it to pay out.

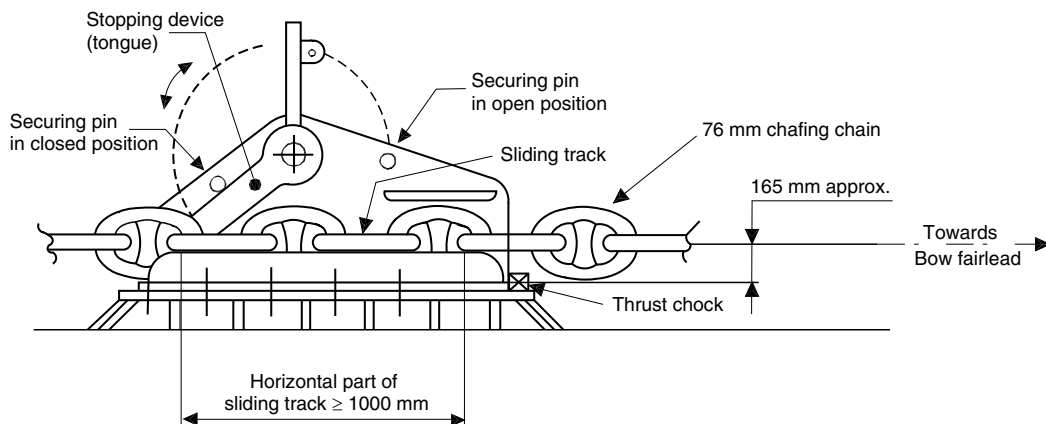
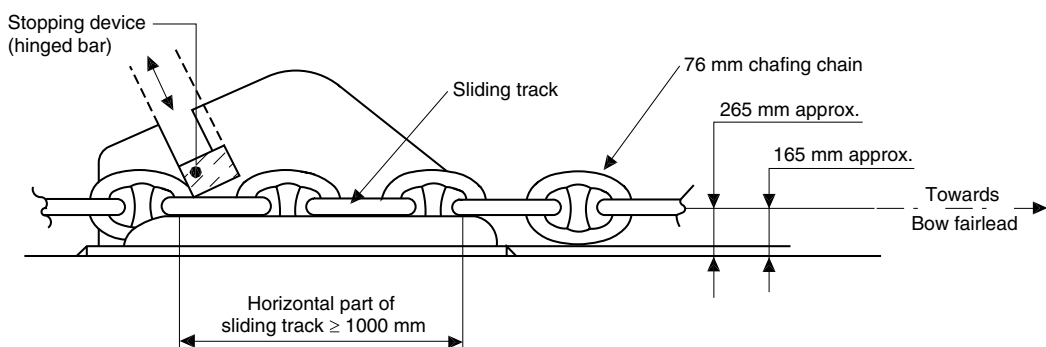
Stopping devices are to be easy and safe to operate and, in the open position, are to be properly secured.

5.1.5 Chain stoppers are to be located between 2,7 m and 3,7 m inboard from the bow fairleads (see Fig 1, Fig 2 and Fig 3).

When positioning, due consideration is to be given to the correct alignment of the stopper relative to the direct lead between bow fairlead and pedestal roller fairlead.



Figure 4 : Typical bow chain stoppers

*Pawl type chain stopper**Bar hinged type chain stopper*

**5.1.6** Stopper support structures are to be trimmed to compensate for any camber and/or sheer of the deck. The leading edge of the stopper base plate is to be faired to allow for the unimpeded entry of the chafing chain into the stopper.

**5.1.7** Where the chain stopper is bolted to a seating welded to the deck, the bolts are to be relieved from shear force by efficient thrust chocks capable of withstanding a horizontal force equal to 1,3 times the required working strength and, in such condition, meeting the strength criteria specified in [7].

The steel quality of bolts is to be not less than grade 8.8 as defined by ISO standard No. 898/1 (Grade 10.9 is recommended).

Bolts are to be pre-stressed in compliance with appropriate standards and their tightening is to be suitably checked.

**5.1.8** The chain stopper is to be made of fabricated steel (see NR216 Materials and Welding, Ch 2, Sec 1) or other ductile material such as steel forging or steel casting complying with the requirements of NR216 Materials and Welding, Ch 2, Sec 3 and NR216 Materials and Welding, Ch 2, Sec 4, respectively.

**5.1.9** Use of spheroidal graphite (SG) iron casting (see NR216 Materials and Welding, Ch 2, Sec 5) may be accepted for the main framing of the chain stopper provided that:

- the part concerned is not intended to be a component part of a welded assembly
- the SG iron casting is of ferritic structure with an elongation not less than 12%
- the yield stress at 0,2% is measured and certified
- the internal structure of the component is inspected by means of non-destructive examinations.

**5.1.10** The material used for the stopping device (pawl or hinged bar) of chain stoppers is to have mechanical properties similar to grade Q3 chain cable defined in NR216 Materials and Welding, Ch 4, Sec 1.

## 5.2 Bow fairleads

**5.2.1** One bow fairlead is to be fitted for each bow chain stopper.

**5.2.2** For ships of more than 150000 t DWT, where two bow fairleads are required, the fairleads are to be spaced 2,0 m centre to centre apart, if practicable, and in no case more than 3,0 m apart.

For ships of 150000 t DWT or less, for which only one bow fairlead is required (see Tab 1), it is generally to be fitted on the centreline.

**5.2.3** Bow fairleads are to be capable of withstanding a load equivalent to the safe working load (SWL) of the bow chain stopper that they serve (see [4.1]) and, in such condition, meeting the strength criteria specified in [7]. The load position is to be based on hawser angles as follows:

- in the horizontal plane, up to 90° from the ship's centre-line, both starboard and portside
- in the vertical plane, up to 30° above and below horizontal.

**5.2.4** Fairleads are normally of a closed type (such as Panama chocks) and are to have an opening large enough to pass the largest portion of the chafing gear, pick-up rope and associated fittings.

For this purpose, the inner dimensions of the bow fairlead opening are to be at least 600 mm in width and 450 mm in height.

**5.2.5** Fairleads are to be oval or round in shape.

The lips of the fairleads are to be suitably faired in order to prevent the chafing chain from fouling on the lower lip when heaving inboard.

The bending ratio (bearing surface diameter of the fairlead to chafing chain diameter) is to be not less than 7 to 1.

**5.2.6** The fairleads are to be located as close as possible to the deck and, in any case, in such a position that the chafing chain is approximately parallel to the deck when it is under strain between the chain stopper and the fairlead.

**5.2.7** Fairleads are to be made of fabricated steel plates (see NR216 Materials and Welding, Ch 2, Sec 1) or other ductile material such as weldable steel forging or steel casting complying with the requirements of NR216 Materials and Welding, Ch 2, Sec 3 and NR216 Materials and Welding, Ch 2, Sec 4, respectively.

### 5.3 Pedestal roller fairleads

**5.3.1** Pedestal roller fairleads are to be used only when the mooring arrangement design is not permitting direct straight leads to a winch storage drum. The number of pedestal roller fairleads for each bow chain stopper is not to exceed two, and the angle of change of direction of the pick-up rope is to be kept as low as possible.

The pedestal roller fairleads are to be fitted not less than 3 m behind the bow chain stopper.

Typical arrangements using pedestal roller fairleads are shown in Fig 1, Fig 2 and Fig 3.

**5.3.2** The pedestal roller fairleads are to be capable of withstanding a horizontal force equal to the greater of the values:

- 225 kN
- the resultant force due to an assumed pull of 225 kN in the pick-up rope.

Stresses generated by this horizontal force are to comply with the strength criteria indicated in [7].

**5.3.3** It is recommended that the fairlead roller should have a diameter not less than 7 times the diameter of the pick-up rope. Where the diameter of the pick-up rope is unknown it is recommended that the roller diameter should be at least 400 mm.

### 5.4 Winches or capstans

**5.4.1** Winches or capstans used to handle the mooring gear are to be capable of heaving inboard a load of at least 15 t. For this purpose winches or capstans are to be capable of exerting a continuous duty pull of not less than 150 kN and withstanding a braking pull of not less than 225 kN.

**5.4.2** If a winch storage drum is used to stow the pick-up rope, it is to be of sufficient size to accommodate 150 m of rope of 80 mm diameter.

## 6 Supporting hull structures

### 6.1 General

**6.1.1** The bulwark plating and stays are to be suitably reinforced in the region of the fairleads.

**6.1.2** Deck structures in way of bow chain stoppers, including deck seatings and deck connections, are to be suitably reinforced to resist a horizontal load equal to 1,3 times the required working strength and, in such condition, to meet the strength criteria specified in [7].

For deck bolted chain stoppers, reinforcements are to comply with [5.1.7].

**6.1.3** The deck structures in way of the pedestal roller fairleads and in way of winches or capstans as well as the deck connections are to be reinforced to withstand, respectively, the horizontal force defined in [5.3.2] or the braking pull defined in [5.4.1] and to meet the strength criteria specified in [7].

**6.1.4** Main welds of the bow chain stoppers with the hull structure are to be 100% inspected by means of non-destructive examinations.

## 7 Strength criteria

### 7.1 General

**7.1.1** The equivalent stress  $\sigma_{VM}$  induced by the loads in the equipment components (see [3.3]) is to be in compliance with the following formula:

$$\sigma_{VM} \leq \sigma_a$$

where:

$\sigma_a$  : Permissible stress, to be taken, in N/mm<sup>2</sup>, as the lower of 0,5  $R_{eH}$  and 0,3  $R_m$

$R_{eH}$  : Minimum yield stress, in N/mm<sup>2</sup>, of the component material

$R_m$  : Tensile strength, in N/mm<sup>2</sup>, of the component material.

## SECTION 5

## CONTAINER LASHING EQUIPMENT (LASHING)

### 1 General

#### 1.1 Application

**1.1.1** The additional class notation **LASHING** is assigned, in accordance with Pt A, Ch 1, Sec 2, [6.14.5], to ships carrying containers and equipped with fixed and portable lashing equipment complying with the requirements of this Section.

**1.1.2** The additional class notation **LASHING** intends to assess lashing patterns in environmental conditions corresponding to Unrestricted Navigation (i.e. based on the North-Atlantic scatter diagram as per NR583 for Whipping and Springing Assessment).

**1.1.3** The additional class notation **LASHING-WW** may be assigned in lieu of the notation **LASHING**, except if the ship is intended to be operated solely in North-Atlantic or North-Pacific area.

**1.1.4** The additional class notation **LASHING-WW** intends to assess lashing patterns in environmental conditions corresponding to a worldwide scatter diagram (see NR583).

**1.1.5** The additional class notation **LASHING (specific area)** may be assigned in lieu of the notation **LASHING** to ships navigating only in specific restricted areas such as Baltic Sea, Mediterranean Sea or South China Sea.

**1.1.6** In order for the notation **LASHING (specific area)** to be granted, all requirements of the notation **LASHING-WW** are to be fulfilled with values of accelerations used for lashing calculations derived on the basis of a specific wave scatter diagram.

#### 1.2 Requirements

**1.2.1** The requirements for additional class notation **LASHING**, **LASHING-WW** and **LASHING (specific area)** are to be in accordance with NR625, Ch 14, Sec 1.

**1.2.2** The procedure for the assignment of the additional class notations **LASHING** and **LASHING-WW** includes:

- approval of the lashing plans and approval of fixed and portable lashing equipment
- type tests of the fixed and portable lashing equipment and issuance of Type Approval Certificates for these equipment
- inspection at the works during manufacture of the fixed and portable lashing equipment and issuance of Inspection Certificates for these equipment
- general survey on board of fixed and portable lashing equipment and sample test of mounting of equipment
- approval of the lashing software when relevant.

**1.2.3** In the case of a ship granted with the additional class notations **LASHING-WW** or **LASHING (specific area)**, the container stowage plan is to contain at least two configurations of a full bay calculated with the unrestricted environmental conditions. These configurations are to represent typical loading for the midship area (e.g. twenty standards and forty standards).

#### 1.3 Documents and information

##### 1.3.1 Documents to be submitted

The following drawings and documents are to be submitted to the Society for review:

- container stowage plan, describing the arrangement of containers in hold, on deck and on hatch covers. The plan shall also include the gross weight of containers and the maximum design weight of container stacks
- fixed lashing equipment plan, showing the location of all fixed lashing equipment, as well as drawings and informations
- a complete list of portable lashing equipment, together with the drawings and information as requested in
- all relevant test reports and certificates of the different fixed and portable lashing devices used onboard
- test cases of the lashing software.

All these documents are to be kept onboard after they have been reviewed.

# SECTION 6 DYNAMIC POSITIONING (DYNAPOS)

## 1 General

### 1.1 Application

**1.1.1** The additional class notation **DYNAPOS** is assigned, in accordance with Pt A, Ch 1, Sec 2, [6.14.6], to ships fitted with dynamic positioning installations complying with the requirements of this Section.

This notation is completed by additional symbols defined in [1.4], according to the operational mode of the installation.

**1.1.2** These requirements are additional to those applicable to the classification of the corresponding ships or mobile offshore units. Attention is drawn to the fact that dynamic positioning installations may be required to comply with existing national regulations.

**1.1.3** With reference to the Rules for the Classification of Ships, the following requirements apply:

- Pt C, Ch 1, Sec 2 when the thruster is driven by an internal combustion engine
- Pt C, Ch 1, Sec 12 for azimuthal and transverse thrusters.

### 1.2 Definitions

#### 1.2.1 Active failure

Active failure concerns all failures which have an immediate effect either on the operation of the installations or on the monitoring circuits.

#### 1.2.2 Activity-specific operating guidelines (ASOG)

Guidelines on the operational, environmental and equipment performance limits for the location and specific activity.

#### 1.2.3 Alarm devices

Visual and audible signals enabling the operator to immediately identify any failure of the positioning system.

#### 1.2.4 Bus-tie breaker

A device connecting/disconnecting switchboard sections ("closed bus-tie(s)" means connected).

#### 1.2.5 Computer system

A system consisting of one or more computers and associated hardware, software and their interfaces.

#### 1.2.6 Consequence analysis

A software function continuously verifying that the vessel will remain in position even if the worst-case failure occurs.

#### 1.2.7 Dynamic positioning control station (DP control station)

A workstation designated for DP operations, where necessary information sources, such as indicators, displays, alarm panels, control panels and internal communication systems are installed (this includes: DP control and independent joystick control operator stations, required position DP system reference systems' Human Machine Interface (HMI), manual thruster levers, mode change systems, thruster emergency stops, internal communications).

#### 1.2.8 Dynamic positioning operation (DP operation)

Using the DP system to control at least two degrees of freedom in the horizontal plane automatically.

#### 1.2.9 Dynamically positioned vessel (DP vessel)

A unit or a vessel which automatically maintains its position and/or heading (fixed location, relative location or predetermined track) by means of thruster force.

#### 1.2.10 Environment

Environmental conditions include wind, current and waves. Ice loads are not taken into account.

#### 1.2.11 Failure

An occurrence in a component or system that causes one or both of the following effects:

- loss of component or system function; and/or
- deterioration of functional capability to such an extent that the safety of the vessel, personnel or environmental protection is significantly reduced.

#### 1.2.12 Failure modes and effects analysis (FMEA)

A systematic analysis of systems and sub-systems to a level of detail that identifies all potential failure modes, down to the appropriate sub-system level, and their consequences.

#### 1.2.13 FMEA proving trials

The test program for verifying the FMEA.

#### 1.2.14 Hidden failure

A failure that is not immediately evident to operations or maintenance personnel and has the potential for failure of equipment to perform an on-demand function, such as protective functions in power plants and switchboards, standby equipment, backup power supplies or lack of capacity or performance.

#### 1.2.15 Joystick system

A system with centralised manual position control and manual or automatic heading control.

#### 1.2.16 Loss of position and/or heading

The vessel's position and/or heading is outside the limits set for carrying out the DP activity in progress.

### 1.2.17 Position keeping

Maintaining a desired position and/or heading or track within the normal excursions of the control system and the defined environmental conditions (e.g. wind, waves, current, etc.).

### 1.2.18 Power management system

A system that ensures continuity of electrical supply under all operating conditions.

### 1.2.19 Redundancy

The ability of a component or system to maintain or restore its function when a single failure has occurred. Redundancy can be achieved, for instance, by the installation of multiple components, systems or alternative means of performing a function.

### 1.2.20 Time to safely terminate (operations)

The amount of time required in an emergency to safely cease operations of the DP vessel.

### 1.2.21 Worst-case failure design intent (WCFDI)

The specified minimum DP system capabilities to be maintained following the worst-case failure. The worst-case failure design intent is used as the basis of the design. This usually relates to the number of thrusters and generators that can simultaneously fail.

### 1.2.22 Worst-Case Failure (WCF)

The identified single fault in the DP system resulting in maximum detrimental effect on DP capability as determined through the FMEA.

## 1.3 Dynamic positioning sub-systems

**1.3.1** The installation necessary for dynamically positioning a vessel comprises, but is not limited to, the following sub-systems:

- power system, i.e. all components and systems necessary to supply the DP system with power
- thruster system, i.e. all components and systems necessary to supply the DP system with thrust force and direction
- DP control system, i.e. all control components and systems, hardware and software necessary to dynamically position the vessel.

**1.3.2** Power system means all components and systems necessary to supply the DP system with power. The power system includes but is not limited to:

- prime movers with necessary auxiliary systems including piping, fuel, cooling, pre-lubrication and lubrication, hydraulic, pre-heating, and pneumatic systems
- generators
- switchboards
- distribution systems (cabling and cable routing)
- power supplies, including uninterruptible power supplies (UPS), and
- power management system(s) (as appropriate).

**1.3.3** Thruster system means all components and systems necessary to supply the DP system with thrust force and direction. The thruster system includes:

- thrusters with drive units and necessary auxiliary systems including piping, cooling, hydraulic, and lubrication systems, etc.
- main propellers and rudders if these are under the control of the DP system
- thruster control system(s)
- manual thruster controls, and
- associated cabling and cable routing.

**1.3.4** Dynamic Positioning control system (DP control system) means all control components and systems, hardware and software necessary to dynamically position the vessel. The DP control system consists of the following:

- computer system/joystick system
- sensor system(s)
- control stations and display system (operator panels)
- position reference system(s)
- associated cabling and cable routing, and
- networks.

## 1.4 Additional and optional class notation

**1.4.1** The notation **DYNAPOS** is completed by one of the following additional notations according to the operational mode of the installation:

- **SAM** (semi-automatic mode). The operator's manual intervention is necessary for position keeping:
  - the control system of installations receiving the notation **SAM** is to achieve synthetic control of all the thrusters thanks to a simple single device (for instance a joystick)
  - the control system is to indicate the position and heading of the unit to the operator. Control settings are to be displayed
  - the control device handle is to have a well-defined neutral position (no thrust)
  - any dynamic positioning installation provided with an automatic control is to be additionally fitted with a manual manoeuvring control complying with the requirements of the **SAM** notation.
- **AM** (automatic mode): position keeping is automatically achieved.
- **AT** (automatic tracking): the unit is maintained along a predetermined path, at a preset speed and with a preset heading which can be completely different from the course.
- **AM/AT**: the installation combines the **AM** and **AT** capabilities.

Note 1: When the notation **AM/AT** is used in the rest of this Section, the corresponding requirements are applicable to notations **AM** or **AT** or **AM/AT**.

**1.4.2** Installations intended to be assigned the notation **DYNAPOS AM/AT** are to be provided with a calculation unit including, in addition to the computer, a reference clock and peripheral equipment for visualisation and printing.

The computer type and features are to comply with the requirements regarding performance in environmental conditions to the satisfaction of the Society.

Calculation cycle fulfilment is to be automatically monitored. Any failure of the computer is to activate a visual and audible alarm.

**1.4.3** For the **DYNAPOS AM/AT** notation, the ship is to be fitted with an automatic control and a standby manual control, the latter being equivalent to the control system required for the **SAM** notation.

**1.4.4** The optional additional notation **DYNAPOS AM/AT** may be completed by the following symbols:

- **R**, when the dynamic positioning is provided with redundancy means, as defined in [1.2.19]. In this case, class 2 equipment as per Article [3] is to be used
- **RS**, when in addition to symbol **R**, the redundancy is achieved by using two systems or alternative means of performing a function physically separated as defined in [4.8.6] below. Equipment class 3 as per Article [3] is to be used for installations to be granted symbol **RS**.

**1.4.5** The notation **-EI** is added to the additional class notation **DYNAPOS AM/AT R** (DP Class 2) or **DYNAPOS AM/AT RS** (DP Class 3) when the ship is fitted with an enhanced dynamic positioning control system in compliance with the requirements of Article [10].

**1.4.6** The notations mentioned in [1.4.2] to [1.4.5] may be supplemented with an environmental station keeping number **ESKI** which indicates the station keeping capability of the vessel (as a percentage of time) under given environmental conditions. See Article [9].

**1.4.7** The notation **-HWIL** is added to the additional class notation **DYNAPOS** when the control system has been verified according to the requirements of NR632 Hardware-in-the-loop Testing.

**1.4.8** The notation **-DDPS** is added to the additional class notation **DYNAPOS AM/AT R** (DP Class 2) or **DYNAPOS AM/AT RS** (DP Class 3) when the ship is fitted with a system which enables the vessel to undertake digital surveys in compliance with the requirements of Article [11].

#### **1.4.9 Association of DP system with position mooring system**

These Rules do not cover the association of the dynamic system with a position mooring system; in such case a special examination of the installations is to be carried out by the Society. Technical considerations concerning this type of installation are given in [4.1.6] for information.

**1.4.10** The practical choice of the dynamic positioning classification notation is governed by the following guidelines:

- The notation **DYNAPOS SAM** is not granted to the following types of units:
  - diving support vessel
  - cable and pipe laying ship
  - lifting units
- Supply vessels fitted with installations intended for position keeping alongside offshore work units may be granted the notation **DYNAPOS SAM** or **DYNAPOS AM/AT**.

## **1.5 Installation survey during construction**

**1.5.1** Installations built under special survey are subject to:

- examination of documents with consideration of those specified in [1.6]
- surveys during fabrication and component testing carried out at the supplier's works and at the yard
- dock and sea trials with a Surveyor from the Society in attendance.

## **1.6 List of documents to be submitted**

**1.6.1** In addition to the drawings and specifications required by the Rules for the Classification of Ships, the documents listed in Tab 1 are required.

## **2 Performance analysis**

### **2.1 General**

**2.1.1** A performance analysis of the dynamic positioning installation is normally required in order to justify design options and limit allowable environmental conditions. This analysis is to consider the main features of the DP installation:

- characteristics of control laws
- installed power
- sizing and location of thrusters

with regard to the required station keeping stability and accuracy in the specified environmental conditions.

### **2.2 Condition of analysis**

**2.2.1** The environmental conditions to be considered in the analysis are normally defined by the Owner for the intended service of the unit. However, for symbol **R** assignment, the following situations are to be considered:

- normal environmental conditions: those environmental conditions in which nominal position holding performances are attained, while the unit is in the normal working situation
- safety environmental conditions: environmental conditions such that any single failure of a thruster or generator unit occurring in service does not impair position keeping or operational safety
- limiting environmental conditions: those environmental conditions in which position keeping is possible with all thrusters running, only installations essential for safety being in service.

When symbol **R** assignment is not required, the analysis may be limited to normal environmental conditions, in any event considering single failure of a generating set. The required analysis may be performed either:

- by a mathematical model of the behaviour of the unit, possibly associated with tank test results, or
- on the basis of previous operational experience gained on similar installations.

## 2.3 Modelling and simulations

**2.3.1** A simulation of the unit displacements in relation to applied environmental forces is normally required for symbol **R** assignment.

**2.3.2** The simulation required in [2.3.1] is notably to include suitable modelling of the following:

- environmental forces (e.g. wind, currents)
- hydrodynamic behaviour of the unit
- dynamic action of thrusters
- control loop.

Simulation results are to include displacements of the unit as well as power determination for each case under consideration.

Note 1: The simulation is to take account of the response of the unit to oscillating forces of positive average (waves, wind, possible external links) likely to have a resonant action upon the dynamic system composed of the unit together with its DP system.

**Table 1 : Documents to be submitted**

No.	I/A (1)	Documents to be submitted
1	A	Documentation on the environment conditions long term distribution (see [9.4.1])
2	I	Owner performance request, if any
3	A	Diagram of the environmental limit conditions (also called capability plot) for the conditions defined in the specification and at least with all thrusters running and selected in DP, and the worst case failure.
4	A	Functional block diagram of the sensor and reference systems (position/environmental conditions)
5	A	Functional block diagram of the control unit
6	A	Single line diagram and specification of the cables between the different equipment units (power, control, display)
7	A	Electrical power balance
8	A	List of the equipment units with, for each one, Manufacturer's identification, type and model
9	A	Type test reports for the sensors of the measurement systems, or equivalent
10	A (3)	Type test report or case-by-case approval certificate for the DP control system
11	A	For approval of propulsion, based on rotary azimuth thrusters: <ul style="list-style-type: none"> <li>- layout drawings of thrust units, thrust shafts and blocks</li> <li>- arrangement of hull passages</li> <li>- thrust curves of each propulsion unit</li> </ul>
12	A	Electrical power management layout drawings and specification if provided on board
13	A	Internal communication system description
14	A	Description of the control stations (layout on board, descriptive diagrams of the display consoles)
15	A	Alarm list and parameter values displayed on the consoles
16	A	Program of FMEA Proving tests alongside quay and at sea
17	A (2)	Simulation report of the behaviour of the unit
18	A (2)	Analysis of consequences of single failures in accordance with rule requirements in the form of a failure mode and effect analysis (FMEA).
19	A (2)	Study of possible interaction between thrusters
20	I	Technical specification of the positioning system
21	I	Operating manual of the positioning system including: <ul style="list-style-type: none"> <li>- description of the equipment</li> <li>- maintenance guide</li> <li>- emergency procedures.</li> </ul>
22	I	Vessel-specific DP-operation manuals
23	I	Program of FMEA Annual tests alongside quay and at sea
<p>(1) A : To be submitted for approval I : To be submitted for information.</p> <p>(2) For symbols <b>R</b> and <b>RS</b> only.</p> <p>(3) Tests to be in accordance with Pt C, Ch 3, Sec 6</p>		

## 2.4 Failure mode and effects analysis

**2.4.1** For installation intended to be assigned the notation **DYNAPOS AM/AT-R** and **DYNAPOS AM/AT-RS** an FMEA is to be carried out. This is a systematic analysis of systems and subsystems to the level of detail required to demonstrate that no single failure as defined in [3.2] will cause a loss of position and/or heading and is to establish worst-case failure design intent.

**2.4.2** The FMEA is to provide general vessel information and specify the overall acceptance criteria, i.e. notation(s), to allow the Society to understand how the (sub) systems work at a level that allows them to correctly assess their failure modes. The systems can be organised as per Tab 2.

**2.4.3** Each system should be considered in a top-down approach, starting from the system's functional output, and failure is to be assumed by one possible cause at a time. Since a failure mode may have more than one cause, all potential independent causes for each failure mode are to be identified.

**2.4.4** The analysis within the FMEA is to show the level of redundancy of each sub-system as well as the consequences of possible common mode failures. Therefore, each physically and functionally independent sub-system and the associated failure modes with their failure causes related to normal operational modes of the sub-system are to be described.

**2.4.5** Where cross connections between redundant groups exist, fault tolerance, fault resistance and the potential for fault propagation are to be analysed by the FMEA and proven during the DP proving trials. The FMEA study in general only analyses failure effects based on a single failure in the system and therefore a failure detection means, such as visual or audible warning devices, automatic sensing devices, sensing instrumentation or other unique indica-

tions, is to be identified. Where applicable, mitigating factors need to be stated.

**2.4.6** Where the system element failure is non-detectable (i.e. a hidden fault or any failure which does not give any visual or audible indication to the operator) and the system can continue with its specific operation, the analysis is to be extended to determine the effects of a second failure, which in combination with the first undetectable failure may result in a more severe failure effect e.g. hazardous or catastrophic effect. For installations intended to be assigned the notation **DYNAPOS AM/AT-RS**, the FMEA is to state the separation design intent and give descriptions of the installation of redundant sub-systems in fire and flooding protected compartments and zones. The method of separating the different zones are to be identified. The design is to be analysed and is to contain a conclusion on whether the separation design intent is met.

**2.4.7** A test program specifying tests to verify assumptions and conclusions within the FMEA is to be drawn up and submitted to the Society for approval.

**2.4.8** The FMEA is to summarise and conclude as a minimum the following:

- for each sub-system analysed, the conclusions are to be stated
- for the total DP system, an overall conclusion is to be stated identifying the most critical sub-system
- a compliance statement referring to the acceptance criterion and with reference to the capability polar plots as defined in 7.1.6.

The report is to contain the test programme, reference any other test reports and the FMEA trials.

**2.4.9** The FMEA is to be kept updated and is to be available on board for inspection by the Society.

**Table 2 : Major DP equipment**

No.	System	Subsystem
1	DP Control	Computers and consoles, networks, hardware architecture, position reference sensors, environmental sensors, etc.
2	Power Generation	Generators, voltage regulators, governors, generator and bus bar protection systems, etc.
3	Power Distribution	High and low voltage AC distribution systems, emergency systems configuration and distribution, UPS systems configuration and distribution, low voltage DC distribution systems and control power supplies, bus tiebreakers and breaker interlocks, etc.
4	Propulsion System	Main propellers and/or thrusters and their drives, hydraulic systems, lubrication systems, emergency stops, steering gear, gearboxes, cooling system, control loops, manual, joystick, DP interfaces, etc.
5	Control System	Integrated control system, thruster control systems, vessel management system, power management system (including load sharing, load shedding, load reduction, and black out recovery), data networks, hardware architecture, etc.
6	Machinery System	Prime movers, fuel system, freshwater and seawater cooling systems, lubrication systems, compressed air systems, remote controlled valve systems, heating, ventilation, and air conditioning (HVAC), etc.
7	Safety system	Fire and gas detection systems, fire extinguishing systems, emergency shutdown system, quick closing valves, etc.



### 3 Equipment class

#### 3.1 General

**3.1.1** The DP-vessel is to be operated in such a way that the worst-case failure, as determined in [2.4.1], can occur at any time without causing a breach of acceptable excursion criteria set for loss of position and/or heading for equipment classes 2 and 3.

**3.1.2** When a DP-vessel is assigned an equipment class, this means that the DP-vessel is suitable for all types of DP-operations within the assigned and lower equipment classes.

#### 3.2 Equipment class according to single failure

**3.2.1** For **DYNAPOS AM/AT**, equipment class 1 is required. In this case loss of position and/or heading may occur in the event of a single failure.

**3.2.2** For **DYNAPOS AM/AT R**, equipment class 2 is required. A loss of position and/or heading is not to occur in the event of a single failure in any active component or system. Common static components may be accepted in systems which will not immediately affect position keeping capabilities upon failure (e.g. ventilation and seawater systems not directly cooling running machinery). Normally such static components will not be considered to fail under reserve that they are built and installed in accordance with the rules of classification of the ship. Single failure criteria include, but are not limited to:

- any active component or system (generators, thrusters, switchboards, communication networks, remote-controlled valves, etc.); and
- any normally static component (cables, pipes, manual valves, etc.) that may immediately affect position keeping capabilities upon failure or is not properly documented with respect to protection.

**3.2.3** For **DYNAPOS AM/AT RS**, equipment class 3 is required. A loss of position and/or heading is not to occur in the event of a single failure in any active component or system, as specified above for class 2. In this case a single failure includes:

- items listed above for class 2, and any normally static component is assumed to fail
- all components in any one watertight compartment, from fire or flooding
- all components in any one fire subdivision, from fire or flooding. For cables, see [6.1.2].

**3.2.4** For equipment classes 2 and 3, a single inadvertent act is to be considered as a single failure if such an act is reasonably probable.

### 4 Functional requirements

#### 4.1 General

**4.1.1** All components in a DP system are to comply with the relevant Rules for the Classification of Ships.

**4.1.2** In order to meet the single failure criteria given in [3.2], redundancy of components will normally be necessary as follows:

- for equipment class 2 (for symbol **R**), redundancy of all active components
- for equipment class 3 (for symbol **RS**), redundancy of all components and A-60 physical separation of the components.

For equipment class 3, full redundancy of the control system may not always be possible (e.g., there may be a need for a single change-over system from the main computer system to the backup computer system). Non-redundant connections between otherwise redundant and separated systems may be accepted provided that these are operated so that they do not represent a possible failure propagation path during DP operations. Such connections are to be kept to the absolute minimum and made to fail to the safest condition. Failure in one system is in no case to be transferred to the other redundant system.

**4.1.3** Redundant components and systems are to be immediately available without needing manual intervention from the operators and with such capacity that the DP operation can be continued for such a period that the work in progress can be terminated safely. The transfer of control is to be smooth and within acceptable limitations of the DP operation(s) for which the vessel is designed.

**4.1.4** If external forces from mission-related systems (cable lay, pipe lay, mooring, etc.) have a direct impact on DP performance, the influence of these systems are to be considered and factored into the DP system design. Where available from the DP system or equipment manufacturer, such data inputs are to be provided automatically to the DP control system. Additionally, provisions are to be made to provide such data inputs into the DP control system manually. These systems and the associated automatic inputs are to be subject to analysis, as specified in [2.4], and surveys and testing specified in [8.2].

The analysis of the consequences of anchor line breaks or thruster failure is to be carried out according to the operational situation.

**4.1.5** For symbol **R** or **RS** assignment, hidden failure monitoring is to be provided on all devices where the FMEA shows that a hidden failure will result in a loss of redundancy.

**4.1.6** When associated with position mooring equipment and used to assist the main dynamic positioning in special circumstances of operation, for instance in the vicinity of an offshore platform, this system is to be designed in such a way as to remote control the length and tension of individual anchor lines.

The analysis of the consequences of anchor line breaks or thruster failure is to be carried out according to the operational situation.

## 4.2 Power system

**4.2.1** The electrical installations are to comply with the applicable requirements of the Rules for the Classification of Ships, in particular for the following items:

- general conditions
- power supply systems
- rotating electrical machinery
- transformers
- switchboards
- electrical cables
- electrical batteries
- rectifiers
- electronic equipment
- electromagnetic clutches and brakes, with special consideration for the Rules applicable to the electric propulsion system, see Pt C, Ch 2, Sec 14.

**4.2.2** System configuration requirements for main power supply and propulsion systems is detailed in Tab 3.

**4.2.3** The power system is to have an adequate response time to power demand changes.

**4.2.4** For equipment class 1, the power system need not be redundant.

**4.2.5** For equipment class 2, the power system (generators, main busbars, etc.) is to be divisible into two or more systems so that, in the event of failure of one sub-system, at least one other system will remain in operation. The power system(s) may be run as one system during operation, but is to be arranged with bus tie breaker(s) to separate the systems automatically upon failures, to prevent the transfer of failure of one system to the other, including, but not limited to, overloading and short circuits.

**4.2.6** For equipment class 3, the power system (generators, main busbars, etc.) is to be divisible into two or more systems such that in the event of failure of one system, at least one other system will remain in operation. The divided power system is to be located in different spaces separated by A-60 class divisions, or equivalent. Where the power systems are located below the operational waterline, the separation is also to be watertight. Bus tie breakers are to be open during equipment class 3 operations unless equivalent integrity of power operation can be accepted according to [4.1.2].

**4.2.7** For equipment classes 2 (symbol **R**) and 3 (symbol **RS**), the following applies:

- The power available for position keeping is to be sufficient to maintain the vessel in position after worst-case

failure as per [3.2.2] and [3.2.3]. The automatic power management system is to be capable of:

- enabling quick supply of active power to consumers in all operating conditions including generator failure or change of thruster configuration
- monitoring power sources and informing the operator about desirable configuration changes such as starting or stopping of generators
- providing automatic change-over of a generating set in case of detected failure; this required capability mainly applies to normal operating conditions. It is to be possible to maintain a proper balance between power demand and power generating configuration, in view of achieving efficient operation with sufficient reserve to avoid blackout
- providing black-out prevention function (automatic load shedding of non-essential services and/or limitation of absorbed power).
- Adequate redundancy of the power management system is to be provided.

The power management system is also to have a black-out prevention function.

- In addition, the following may be required of the automatic power management system:
  - assessment of priority criteria in regard to load shedding
  - suitable automatic power limitations. For instance, gradation may be required to allow safe achievement of essential functions before circuit-breaker opening. Proportional cutbacks may be adequately implemented: static rectifier tripping, thrust command limits, etc.
  - any automatic limitation is to activate warning devices. Override arrangements are to be fitted at the operator's disposal
  - implementation of suitable delays in connecting load consumers so as to enable switching on of additional power sources or load shedding.

**4.2.8** Alternative energy storage (e.g. batteries and flywheels) may be used as sources of power to thrusters as long as all relevant redundancy, independence and separation requirements for the relevant notation are complied with. For equipment classes 2 and 3 (symbol **R** or **RS**), the available energy from such sources may be included in the consequence analysis function, required in [4.8.4], when reliable energy measurements can be provided. The energy measurements then need to calculate the remaining time the vessel can hold position and/or heading if the position and/or heading keeping is dependent on the batteries. Alarms are to be generated based on available energy, levels of which may depend on the vessel's operation. However, when the available energy level falls below the calculated time of 30 minutes a continuous alarm is to be generated.

**4.2.9** Sudden load changes resulting from single faults or equipment failures is not to create a blackout.

**Table 3 : System configuration for main power supply and propulsion systems**

Equipment class	–	1	2	3
Additional class notation <b>DYNAPOS</b>	<b>SAM</b>	<b>AM/AT</b>	<b>AM/AT R</b>	<b>AM/AT RS</b>
Distribution system	According to SOLAS and the present Rules		redundant	redundant in separate rooms
Electric generators			redundant	redundant in separate rooms
Main switchboard			1 with bus tie circuit breaker(s) 2 or more circuits equally distributed	2 or more switchboards, with bus tie circuit-breakers normally open, located in separate rooms
Thrusters and associated control systems			redundant	redundant in separate rooms
Power management system			redundant	redundant in separate rooms
<b>Note 1:</b> Redundant is to be understood as defined in [1.2.19].				

### 4.3 Monitoring of the electricity production and propulsion

**4.3.1** As a general rule, the monitoring level of electric generators, their prime movers and power supply equipment, main propulsion diesel engines and electric propulsion are to be in accordance at least with the requirements of the additional classification notation **AUT CCS**. For installations assigned the **DYNAPOS AM/AT RS** class notation, the requirements of **AUT UMS** or **AUT IMS** may be considered.

### 4.4 Thruster system

**4.4.1** The thruster design and construction are to comply with the applicable requirements of the Rules for the Classification of Ships.

**4.4.2** The provisions of this Section apply to fixed axis or orientable thrusters using fixed or orientable pitch propellers installed below the hull and tunnel thrusters. The use of other thruster types (for example cycloidal propellers) is subject to a special examination.

**4.4.3** Electric propulsion installations are to comply with the requirements of Pt C, Ch 2, Sec 14.

**4.4.4** For symbol **R** and **RS** assignment, attention is drawn to the requirements stated in [3.2.2] and [3.2.3].

**4.4.5** The thruster system is to provide adequate thrust in longitudinal and lateral directions, and provide yawing moment for heading control.

**4.4.6** The values of thruster force used in the consequence analysis required in [4.8.4] are to be corrected for interference between thrusters and other effects which would reduce the effective force.

**4.4.7** For **DYNAPOS SAM** and **DYNAPOS AM/AT**, an UPS is to be provided for the control of power and propulsion system defined above. To this end, for a system granted symbols **R** or **RS**, the number of UPS systems is to be in accordance with the result of the FMEA analysis. Unless

otherwise justified, 2 UPS systems are to be provided for symbol **R**. For symbol **RS**, 2 UPS systems are to be installed, one being located in a separate room.

### 4.5 Thruster control

**4.5.1** Closed loop command of thruster pitch, azimuth and RPM is to be provided from the controller. Feedback signals are to be provided by independent sensors connected to the controlled device.

**4.5.2** Controllers are to incorporate features for avoiding commands likely to overload mechanical gearing or prime movers. Control is preferably to be performed using active power measurements.

**4.5.3** Thrusters are to be capable of being easily stopped.

**4.5.4** Each thruster on a DP system is to be capable of being remote-controlled individually, independently of the DP control system.

### 4.6 Thruster monitoring and protection

**4.6.1** Thruster monitoring is to be provided by the controller unit. Thruster monitoring is to enable:

- detection of equipment failures
- monitoring of the correlation between set and achieved values of control parameters.

The following parameters are to be monitored:

- status of thrusters (on-line/off-line)
- pitch, RPM, azimuth
- thruster load level
- electric motor stator winding temperature
- temperature of main bearings (except roller type)
- lube oil and hydraulic fluid pressure and temperature.

**4.6.2** Failure of a thruster system including pitch, azimuth or speed control is to trigger an alarm, and is not to cause an increase in thrust magnitude or change in thrust direction.

**4.6.3** Provision for automatic stop of a thruster is to be restricted to circumstances liable to bring about immediate plant damage and is to be submitted for approval.

**4.6.4** The individual thruster emergency stop systems are to be protected against accidental activation. For equipment classes 2 (symbol **R**) and 3 (symbol **RS**), the thruster emergency stop systems are to have loop monitoring. For equipment class 3, the effects of fire and flooding are to be considered.

## 4.7 DP Control system

**4.7.1** In general, the DP control system is to be arranged in a DP control station where the operator has a good view of the vessel's exterior limits and the surrounding area.

**4.7.2** The DP control station is to display information from the power system, thruster system and DP control system to ensure that these systems are functioning correctly. Information necessary to safely operate the DP system is to be visible at all times. Other information is to be available at the request of the operator.

**4.7.3** Display systems, and the DP control station in particular, are to be based on sound ergonomic principles which promote proper operation of the system. The DP control system is to be arranged for easy selection of the control mode, i.e. manual joystick, or automatic DP control of thrusters, propellers and rudders. The active mode is to be clearly displayed. The following principles apply to the display system:

- segregation of redundant equipment to reduce the possibility of common mode failure occurrence
- ease of access for maintenance purposes
- protection against adverse effects from environment and from electrical and electromagnetic disturbances.

**4.7.4** For equipment classes 2 and 3, operator controls are to be designed so that no single inadvertent act on the operator's panel can lead to a critical condition.

**4.7.5** Alarms and warnings for failures in all systems interfaced to and/or controlled by the DP control system are to be audible and visual. A record of their occurrence and of status changes is to be provided together with any necessary explanations. The alarm list is given for information in Tab 5.

**4.7.6** The DP control system is to prevent failures being transferred from one system to another. The redundant components are to be so arranged that any failed component or components can be easily isolated, so that the other component(s) can take over smoothly with no loss of position and/or heading.

**4.7.7** It is to be possible to control the thrusters manually, by individual levers and by an independent joystick, in the event of failure of the DP control system. If an independent joystick is provided with sensor inputs, failure of the main DP control system is not to affect the integrity of the inputs to the independent joystick. This requirement may be omitted for installation intended to be assigned the notation **DYNAPOS SAM**.

**4.7.8** The software is to be produced in accordance with an appropriate international quality standard recognised by the Society.

**4.7.9** As far as concerns control stations, the following requirements are to be met:

- where several control stations are provided, control is only to be possible from one station at a time, adequate interlocking devices are to be fitted and indication of the station in control is to be displayed at each control station
- alarm and control systems concerning the same function are to be grouped together (position reference system, propulsion, power generation)
- where inadvertent activation of commands may jeopardise the unit's safety, these commands are to be protected (light cover, double triggering or other equivalent devices or procedures)
- a two-way voice communication facility, independent of the unit's general system, is to be provided between the main control station and the following spaces: navigating bridge, engine room and engine control station, other control stations, responsible officer's accommodation, other control locations specific to the task of the unit
- Equipment that should be located at the DP control station includes, but is not limited to:
  - DP control and independent joystick control operator stations
  - manual thruster levers
  - mode change systems
  - thruster emergency stops
  - internal communications, and
  - position reference systems' HMI, when considered necessary.

**4.7.10** A dedicated UPS is to be provided for each DP control system (i.e. minimum one UPS for equipment class 1, two UPSs for equipment class 2 and three UPSs for equipment class 3 with one being located in a separate room) to ensure that any power failure will not affect more than one computer system and its associated components. The reference systems and sensors are to be distributed on the UPSs in the same manner as the control systems they serve, so that any power failure will not cause loss of position keeping ability. An alarm is to be initiated in case of loss of charge power. UPS battery capacity is to provide a minimum of 30 minutes operation following a main supply failure. For equipment classes 2 and 3, the charge power for the UPSs supplying the main control system is to originate from different power systems.

## 4.8 Computers

**4.8.1** For equipment class 1 (symbol **SAM** or **AM/AT**), the DP control system need not be redundant.

**4.8.2** For equipment class 2 (symbol **R**), the DP control system is to consist of at least two computer systems. Common facilities such as self-checking routines, alignment facilities, data transfer arrangements and plant interfaces are not to be capable of causing the failure of more than one computer system. An alarm is to be initiated if any computer fails or is not ready to take control.

**4.8.3** For equipment class 3 (symbol **RS**), the DP control system is to consist of at least two computer systems with self-checking facilities. Common facilities such as self-checking routines, alignment facilities, data transfer arrangements and plant interfaces are not to be capable of causing failure of more than one computer system. In addition, one backup DP control system should be arranged. An alarm is to be initiated if any computer fails or is not ready to take control.

**4.8.4** For equipment classes 2 (symbol **R**) and 3 (symbol **RS**), the DP control system is to include a software function, normally known as "consequence analysis", which continuously verifies that the vessel will remain in position even if the worst-case failure occurs. This analysis is to verify that the thrusters, propellers and rudders (if included under DP control) that remain in operation after the worst-case failure can generate the same resultant thruster force and moment as required before the failure. The consequence analysis is to provide an alarm if the occurrence of a worst-case failure would lead to a loss of position and/or heading due to insufficient thrust for the prevailing environmental conditions (e.g. wind, waves, current, etc.). For operations which will take a long time to safely terminate, the consequence analysis is to include a function which simulates the remaining thrust and power after the worst-case failure, based on input of the environmental conditions. Manual input of weather trend or forecast might be possible, in order to integrate relevant meteorological data in the system, if available.

**4.8.5** Redundant computer systems are to be arranged with automatic transfer of control after a detected failure in one of the computer systems. The automatic transfer of control from one computer system to another is to be smooth with no loss of position and/or heading.

**4.8.6** For equipment class 3 (symbol **RS**), the backup DP control system is to be in a room, separated by an A-60 class division from the main DP control station. During DP operation, this backup control system is to be continuously updated by input from at least one of the required sets of sensors, position reference system, thruster feedback, etc., and to be ready to take over control. The switchover of control to the backup system is to be manual, situated on the backup computer, and is not to be affected by a failure of the main DP control system. Main and backup DP control systems are to be so arranged that at least one system will be able to perform automatic position keeping after any single failure.

**4.8.7** Each DP computer system is to be isolated from other onboard computer systems and communications systems to ensure the integrity of the DP system and command interfaces. This isolation may be effected via hardware and/or software systems and physical separation of cabling and communication lines. Robustness of the isolation is to be verified by analysis and proven by testing. Specific safeguards are to be implemented to ensure the integrity of the DP computer system and prevent the connection of unauthorised or unapproved devices or systems.

**4.8.8** For dynamic positioning control systems based on computer, it is to be demonstrated that the control systems work properly in the environmental conditions prevailing on board ships and offshore platforms. To this end, the DP control systems are to be submitted to the environmental tests defined in Pt C, Ch 3, Sec 6, with special consideration for E.M.I. (Electromagnetic interference).

## 4.9 Independent joystick system

**4.9.1** A joystick system independent of the automatic DP control system is to be arranged. The power supply for the independent joystick system (IJS) is to be independent of the DP control system UPSs. An alarm is to be initiated upon failure of the IJS.

**4.9.2** The independent joystick system is to have automatic heading control.

## 5 Position reference system

### 5.1 General

**5.1.1** As a general rule, a dynamic positioning installation is to include at least two independent reference systems:

- for **SAM** notation assignment, only one reference system is required
- for equipment class 1 (**AM/AT**), at least two independent position reference systems are to be installed and simultaneously available to the DP control system during operation
- for equipment classes 2 (symbol **R**) and 3 (symbol **RS**), at least three independent position reference systems are to be installed and simultaneously available to the DP control system during operation
- position reference systems are to be selected with due consideration to operational requirements, both with regard to restrictions caused by the manner of deployment and expected performance in the working situation
- when two or more position reference systems are required, they are not all to be of the same type, but based on different principles and suitable for the operating conditions, in order to avoid external common cause failure modes.

**5.1.2** As a general rule, the system is to allow for smoothing and mutual adjustment of the inputs originating from various position reference systems and transfer between reference is to be bumpless. Other arrangements are subject to special examination by the Society. Change-over is preferably to take place automatically in the event of failure of the reference system in use.

**5.1.3** Meteorological reports suitable for the operation of the unit are to be made available to the personnel on board.

### 5.2 Arrangement and performance of reference systems

**5.2.1** The position reference systems are to produce data with adequate accuracy and repeatability for the intended DP-operation.

**5.2.2** Visual and audible alarms are to be activated when the unit deviates from the set heading or from the working area determined by the operator. The performance of position reference systems is to be monitored and warnings provided when the signals from the position reference systems are either incorrect or substantially degraded.

**5.2.3** Indication of the reference system in operation is to be given to the operator.

**5.2.4** For equipment class 3, at least one of the position reference systems is to be connected directly to the backup control system and separated by an A-60 class division from other position reference systems.

**5.3 Type of position reference system**

**5.3.1** When an acoustical reference system is used, a hydrophone is to be chosen to minimise the influence of mechanical and acoustical disturbance on the transmission channels, such as propeller noise, spurious reflection on the hull, interference of riser, bubble or mud cluster on the acoustic path.

The directivity of transponders and hydrophones is to be compatible with the availability of the transmission channels in all foreseeable operational conditions. It is to be possible to select the frequency range and the rate of interrogation according to prevailing acoustical conditions, including other acoustical systems possibly in service in the area.

**5.3.2** When a taut wire system is used, materials used for wire rope, tensioning and auxiliary equipment are to be appropriate for marine service. The anchor weight is to be designed to avoid dragging on the sea floor and is not to

induce, on recovery, a wire tension exceeding 60% of its breaking strength. The capacity of the tensioner is to be adapted to the expected movement amplitude of the unit.

**5.3.3** When the signals from the position reference system are likely to be altered by the movement of the unit (rolling, pitching), a correction of the position is to be made. For this purpose, a vertical reference unit of appropriate characteristics with regard to the expected accuracy of position measurement is to be provided. The VRS is to be multiplied in number for assignment of notations **R** and **RS**, as per Tab 4.

**5.4 Other reference systems**

**5.4.1** Other reference systems such as short to medium range radio positioning systems and global positioning systems may be used. Whatever the chosen principle (for example, hyperbolic or polar determination), the accuracy of the position measurement is to be satisfactory in the whole operational area.

**5.4.2** When a GPS or DGPS is used, interested parties are reminded that this equipment is to be designed in accordance with IMO Resolutions A 694 (17), A 813 (19) and MSC 112(73). Such equipment is to be approved, at least by a competent national authority, and the relevant certificate is to be submitted to the Society. For other reference systems the same procedure is to be applied as when the system is covered by an IMO resolution and this document is to be considered.

**5.4.3** The location of the receiving equipment is to be chosen so as to minimise as far as practicable masking effects and interference.

**Table 4 : Configuration for reference systems, vessel sensors and computers**

Equipment class	–	1	2	3
<b>DYNAPOS</b> class notations	<b>SAM</b>	<b>AM/AT</b>	<b>AM/AT R (1)</b>	<b>AM/AT RS (1)</b>
Number of control computers	1	1	2	3, one of them connected to the backup control station
Manual control: joystick, with automatic heading	may be fitted	Yes	Yes	Yes
One man operating the DP system	Yes	Yes	Yes	Yes
Position reference system	1	2 <b>(2)</b>	3 <b>(2)</b>	3, one of them connected to the backup control station <b>(2)</b>
Vertical reference system	1	1	3	3, one of them connected to the backup control station
Wind sensor	1	1	3	3, one of them connected to the backup control station
Gyro	1	2	3	3, one of them connected to the backup control station
<b>(1)</b> When the <b>DYNAPOS</b> notation is supplemented by <b>-EI</b> , reference is made to Tab 8.				
<b>(2)</b> When two or more position reference systems are required, they are not all to be of the same type, but based on different principles and suitable for the operating conditions.				

## 5.5 Vessel sensors

**5.5.1** Vessel sensors are to measure at least vessel heading, vessel motion, wind speed and direction.

### 5.5.2 Arrangement of sensors and monitoring

Sensors are to be as far as possible provided with failure monitors (overheating, power loss):

- inputs from sensors are to be monitored in order to detect possible faults, notably relative to temporal evolution of the signal. As regards the analogue sensors, an alarm is to be triggered in the event of connecting line wire break, short-circuit or low insulation
- inputs from sensors simultaneously in use are to be compared in order to detect significant discrepancy between them
- any failure of automatic change-over between sensors is to activate visual and audible alarms at the control room
- sensors for equipment classes 2 and 3 and sensors used for the same purpose connected to redundant systems are to be arranged independently so that failure of one will not affect the others.

**5.5.3** For equipment class 3 (symbol **RS**), one of each type of sensor is to be connected directly to the backup control system and is to be separated by an A-60 class division from the other sensors. If the data from these sensors is passed to the main DP control system for their use, this system is to be arranged so that a failure in the main DP control system cannot affect the integrity of the signals to the backup DP control system.

**5.5.4** When an equipment class 2 or 3 (for symbols **R** and **RS**), DP control system is fully dependent on correct signals from vessel sensors, then these signals are to be based on

three systems serving the same purpose (i.e., this will result in at least three heading reference sensors being installed).

### 5.5.5 Heading

- For **DYNAPOS SAM**, one gyrocompass or another heading measurement unit of equivalent accuracy is to be provided.

For **DYNAPOS AM/AT**, two gyrocompasses or other sensors of equivalent accuracy are required.

For **DYNAPOS AM/AT R** or **RS**, see [5.5.4] and Tab 4.

- For **DYNAPOS AM/AT R-EI** and **DYNAPOS AM/AT RS-EI**, see [10] and Tab 8.

**5.5.6** Wind speed and direction are to be measured by suitably located wind sensors, due consideration being given to superstructure influence.

**5.5.7** The alarms to be triggered and indication to be displayed are detailed in Tab 5. This list is given for information and can be completed by taking into consideration the installation configuration. This list does not include the alarms which are required by the automated notation assigned to the unit.

## 5.6 Internal Communications

**5.6.1** At least two independent means are to be provided for communication between the DP bridge and any rooms containing equipment critical to DP operations, such as any position in the machinery space or in the control room from which the vessel is supplied with electrical power and/or from which the speed and the direction of the thrust of the pro-pellers may be controlled.

**5.6.2** The two means for communication are to be fed by independent power supplies.

**Table 5 : Alarm and warning system**

No.	Parameters and equipment	Alarms or group of alarms	Signalling
1	Ship coordinates and desired position		X
2	Actual position		X
3	Maximum deviation required		X
4	Deviation from the desired operating area outside the a.m. limits	X	
5	Thruster availability ready for operation		X
6	Thruster in operation		X
7	Thruster failure (this includes thruster controllers and pumps)	X	
8	Thruster command and feedback failures	X	
9	Thruster emergency stop functionality	X	
10	Thruster emergency stop failures	X	
11	Vectorial thrust output outside limit	X	
12	Total output of all thrusters		X for class 2 and class 3 equipment
13	Thrust limitation by available power	X	
14	Power supply failure	X	

No.	Parameters and equipment	Alarms or group of alarms	Signalling
15	Power management failure	X for class 2 and class 3 equipment	
16	Desired heading		X
17	Actual heading		X
18	Deviation from desired heading outside limit	X	
19	Status of each heading reference system connected or not		X
20	Failure of each heading reference system	X	
21	Automatic switching to standby heading reference system	X	
22	Failure of the vertical reference sensor measuring the pitching and rolling of the unit	X	
23	Operational status of each vertical reference sensor		X
24	Automatic switching to vertical standby reference sensor	X	
25	Indication of wind speed and direction sensor		X
26	Operational status of each wind sensors, speed and direction		X
27	Failure of each wind sensor, speed and direction	X	
28	Automatic switching of wind speed and direction sensor	X	
29	Computer/Controller failures	X	
30	Automatic switching to standby computer/controller	X	
31	Abnormal input signals to the computer/controller, analogue input failures	X	
32	Number of generators available		X
33	Failure of each position reference system	X	
34	Status of each position reference system		X
35	Automatic start of standby DGs		X
36	Functionality of the DP joystick		X
37	Operational status of each network		X
38	Network failure	X	
39	Operator station functionality for each operator station		X
40	Operator station failures for each operator station	X	
41	Command transfer functionality between operator stations		X
42	Functionality of the independent joystick		X
43	Unavailability of the independent joystick	X	
44	UPS/Battery system failures	X	
45	Automatic switching to battery power on loss of main power for each UPS/Battery system	X	
46	30 minutes of battery power on loss of main supply for each	X	
47	Diesel generator load sharing functionality		X
48	Diesel generator load sharing failures	X	
49	Diesel generator auxiliary equipment failures	X	
50	Sea water cooling circuit failures	X	
51	Fresh water cooling circuit failures	X	
52	Compressed air failures	X	
53	Power management input failure	X	
54	ESD controller and circuits failures (1)	X	
55	Mission-related equipment failures (2)	X	

(1) Only applicable if the ESD has an impact on the DP system.

(2) Only applicable if the mission-related equipment is connected to or has an impact on the DP system.

**Note 1:** Depending on the DP classification notation required, the above-mentioned list may be simplified.

**Note 2:** Instead of an individual alarm, when it is possible to discriminate the cause of the alarm, an alarm group may be displayed.



## 6 Installation requirements

### 6.1 Cables and piping systems

**6.1.1** For equipment class 2 (symbol **R**), the piping systems for fuel, lubrication, hydraulic oil, cooling water and pneumatic circuits and the cabling of the electric circuits essential for the correct functioning of the DP system are to be located with due regard to fire hazards and mechanical damage.

**6.1.2** For equipment class 3 (symbol **RS**):

- Redundant piping systems (i.e., piping for fuel, cooling water, lubrication oil, hydraulic oil and pneumatic circuits etc.) are not to be routed together through the same compartments. Where this is unavoidable, such pipes may run together in ducts of A-60 class, the termination of the ducts included, which are effectively protected from all fire hazards except that represented by the pipes themselves.
- Cables for redundant equipment or systems are not to be routed together through the same compartments. Where this is unavoidable, such cables may run together in cable ducts of A-60 class, the termination of the ducts included, which are effectively protected from all fire hazards except that represented by the cables themselves. Cable connection boxes are not allowed within such ducts.

**6.1.3** For equipment classes 2 (symbol **R**) and 3 (symbol **RS**), systems not directly part of the DP system but which, in the event of failure, could cause failure of the DP system (common fire suppression systems, engine ventilation systems, heating, ventilation and air conditioning (HVAC) systems, shutdown systems, etc.) are also to comply with the relevant requirements of these Rules.

### 6.2 Thruster location

**6.2.1** The thruster location, operational modes and design are to comply with the following requirements.

**6.2.2** The thruster location and operational modes are to be chosen so as to minimise interference between thrusters as well as disturbance caused to the proper operation of sensor systems or specific equipment the unit is provided with.

**6.2.3** Thruster intake depth is to be sufficient to reduce the probability of ingesting floating debris and of vortex formation.

**6.2.4** The integrity of the hull is not to be adversely affected by thruster installation, particularly where retractable or tunnel thrusters are provided.

**6.2.5** The thruster system is to provide adequate thrust in longitudinal and lateral directions and provide yawing moment for heading control.

**6.2.6** Transverse fixed axis thrusters, if used, are to be capable, for notation **AM/AT**, of providing sufficient thrust in the contemplated range of speed of the unit.

**6.2.7** The values of the thruster forces used in the consequence analysis (see [4.8.4]) are to be corrected for interference between thrusters and other effects which will reduce the effective force.

**6.2.8** For equipment classes 2 and 3, the thruster system is to be connected to the power system in such way that the requirement in [6.2.5] can be complied with, even after failure of one of the constituent power systems and one of the thrusters connected to that system.

## 7 Operational requirements

### 7.1 General

**7.1.1** The following operational conditions are to be fulfilled.

**7.1.2** Before every DP operation, the DP system is to be checked according to an applicable vessel specific "location" checklist(s) and other decision support tools, such as ASOG, in order to make sure that the DP system is functioning correctly and that it has been set up for the appropriate mode of operation.

**7.1.3** During DP-operations, the system should be checked at regular intervals according to the applicable vessel-specific watch-keeping checklist.

**7.1.4** DP-operations necessitating equipment classes 2 or 3 should be terminated when the environmental conditions (e.g. wind, waves, current, etc.) are such that the DP-vessel will no longer be able to keep position if the single failure criterion applicable to the equipment class should occur. In this context, deterioration of environmental conditions and the necessary time to safely terminate the operation are also to be taken into consideration. This should be checked by way of environmental envelopes if operating in equipment class 1 and by way of an automatic means (e.g. consequence analysis) if operating with equipment classes 2 or 3.

**7.1.5** The necessary operating instructions, etc., are to be kept on board.

**7.1.6** DP capability polar plots are to be produced to demonstrate position keeping capacity for fully operational and post worst-case single failure conditions. The capability plots are to represent the environmental conditions in the area of operation and the mission-specific operational condition of the vessel.

**7.1.7** The following checklist, test procedures, trials and instructions are to be incorporated into the vessel-specific DP-operation manuals:

- location checklist, see [7.1.2]
- watch-keeping checklist, see [7.1.3]
- DP-operating instructions, see [7.1.5]
- initial and periodical (5-year) tests and procedures
- annual tests and procedures
- example of tests and procedures after modifications and non-conformities
- blackout recovery procedure
- list of critical components
- examples of operating modes
- decision support tools such as ASOG
- capability plots.

**7.1.8** Reports of tests and records of modifications or equivalent are to be kept on board and made available during periodical inspections.

## 8 Tests and trials

### 8.1 Inspection at works

**8.1.1** Inspections at the works of items subject to classification are to be carried out to the attending Surveyor's satisfaction, in accordance with a previously agreed program.

**8.1.2** Thruster and electrical installation tests are to be conducted in accordance with the requirements for electric propulsion in Pt C, Ch 2, Sec 14.

### 8.2 Trials

**8.2.1** Before a new installation is put into service and after modification of an existing installation, port and sea trials are to be carried out to check the proper functioning and performances of the DP system.

**8.2.2** Test program of these trials is to be submitted in advance to the Society.

**8.2.3** The initial survey is to include a complete test of all systems and components and the ability to keep position and heading after single failures associated with the assigned equipment class. For equipment classes 2 (symbol **R**) and 3 (symbol **RS**), the findings of the FMEA analysis required in [2.4] are to be confirmed by FMEA proving trials.

**8.2.4** Sea trials are to be of sufficient duration to confirm satisfactory operation.

**8.2.5** The final test reports of dock and sea trials are to be submitted.

## 9 Environmental station keeping index ESKI

### 9.1 Definition

**9.1.1** An environmental station keeping index (ESKI) may be associated with each of the class notations defined in [1.4.2] to [1.4.5].

**9.1.2** The ESKI indicates the station keeping capability of the vessel (as a percentage of time) under given environmental conditions.

### 9.2 Environmental conditions

**9.2.1** The ESKI is based on environmental conditions consistent with the geographical area of vessel operation. It is a two numbers vector (xx ; xx).

**9.2.2** For unlimited service, a set of standard North Sea Environmental Conditions is to be used (see Tab 6).

**9.2.3** For restricted service, a long-term distribution of environmental conditions prevailing where the vessel is in operation is to be considered.

### 9.3 Condition of ESKI estimation

**9.3.1** The ESKI indicates the allowable environmental conditions for two system configurations:

- with all thrusters operating
- with the most critical single failure.

Note 1: The most critical failure of any component in the ship is to be considered, which sometimes can lead to the loss of several thrusters at the same time. Taking into account only the failure of the most efficient thrusters would be in some particular cases not relevant.

**9.3.2** The ESKI reflects the capability to maintain position with the most unfavourable heading.

**9.3.3** Environmental forces (wind, wave drift and current loads) and thrust are to be evaluated through calculations, model tests or other method, in agreement with the Society.

### 9.4 Documentation to be submitted and example

**9.4.1** The ESKI calculation is to be documented in order to justify the results. Generally the relevant documents are as follows:

- capability plots for two considered configurations for the calculation: all thrusters alive, most critical single failure
- documentation on the environment conditions long term distribution (any area for restrictive service, North Sea (see Tab 6 for unlimited service)
- owner performance request, if any.

**9.4.2** For unlimited service, North Sea area conditions are to be considered. The wind and wave statistics are indicated in Tab 6.

Table 6 : ESKI / Mean wind speed

Significant wave height, in m	Corresponding mean wind speed (kts)	Annual frequency, in %	ESKI, in %
0 - 1	0 - 4,8	25,2	25
1 - 2	4,8 - 11,6	32,2	57
2 - 3	11,6 - 17,5	20,9	78
3 - 4	17,5 - 24,3	11,1	89
4 - 5	24,3 - 29,1	5,4	95
5 - 6	29,1 - 34,0	2,5	97
6 - 7	34,0 - 37,9	1,2	98
7 - 8	37,9 - 41,8	0,6	99
8 - 9	41,8 - 46,3	0,3	99
9 and more	More than 46,3	0,3	99

**Note 1:** For the calculations, a constant current of 1.5 kts is assumed, in the same direction as the wind and the waves (to sum up all the environmental forces effects).

### 9.4.3 Example of calculation

According to [9.2], the ESKI can be calculated with various environmental data, depending on the service area of the ship. As an example, the calculation for unlimited service (North Sea conditions being the reference) is given hereafter.

For this example, the following results are extracted from the capability plots (see Tab 7). The ESKI is directly read in Tab 6.

- 41,0 kts corresponds to an ESKI of 99
- 25,8 kts correspond to an ESKI of 95

For this vessel, the ESKI number is (99 ; 95).

Note 1: Attention is drawn on the fact that the ESKI should always be read together with the associated capability plots.

Table 7 : Example

Plot	Condition of operation	Maximum allowable (1) wind speed (kt)
1	All thrusters available	41,0
2	Most critical single failure	25,8

(1) On most ships this corresponding incident angle is directly abeam.

## 10 Enhanced DP system

### 10.1 General

**10.1.1** The requirements of the present Article apply to ships fitted with an enhanced dynamic positioning control system, such system improving the reliability, availability and operability of a DP vessel. When compliance with the present Article, the notation **-EI** may be granted as per [1.4.5].

### 10.2 DP Control system

**10.2.1** The DP control system is to consist of at least a main control system and an alternative control system capable to maintain without disruption the position holding capabilities of the unit in case of complicated failure of the main control system. For equipment class 3 (symbol **RS**), the backup control system required in [4.8.3] can be considered as the alternative control system.

**10.2.2** The alternative DP control system is to operate independently of the main DP control system and for equipment class 2 (symbol **R**) may be provided in place of independent joystick system required in [4.9]. In this case in addition to the DP capability this system is to satisfy all of the requirements of the independent joystick system.

**10.2.3** The main DP control system is to consist of two independent and redundant computer systems as specified in [4.8.2] and [4.8.3]. The alternative DP control system is to consist at least of a single and independent computer system ready to take over control of DP operations at any given times in case of failure of the main DP control system. The switch-over of control of the alternative DP control system is to be manual.

**10.2.4** The alternative DP control system is to perform self-checking routines. An audible and visual alarm is to be initiated in the main DP control system in case of failure or unavailability of the alternative DP control system.

**10.2.5** For equipment class 2 (symbol **R**), the main and alternative DP control systems may be located in the same DP control station.

**10.2.6** The main and alternative DP control systems are to be powered by independent power supplies and each one by its own uninterruptible power supply (UPS) capable to provide a minimum of 30 minutes operation following main supply outage.

**10.2.7** In order to allow post incident analysis, a data logger with a storage capacity of 7 days is to be provided to collect automatically and continuously time-stamped events from the DP control systems. The recorded data are to be easily accessible to the operators and are to be available for upload to an offline storage media.

**10.2.8** The following data of the main and alternative DP control system are to be recorded by the data logger:

- Operational status
- All manual input
- All automatic input and output.

**Table 8 : Configuration for reference systems, vessel sensors and computers for enhance reliability DP system**

Equipment class	2	3
DYNAPOS class notations	AM/AT R -EI	AM/AT RS -EI
Number of control computers	3	3
Manual control: joystick, with automatic heading	Yes (1)	Yes
One man operating the DP system	Yes	Yes
Position reference system	4 (2)	4 (3)
Vertical reference system	4 (2)	4 (3)
Wind sensor	4 (2)	4 (3)
Gyro	4 (2)	4 (3)
(1) May be omitted if the alternative DP control system includes also all of the requirements of the independent joystick system		
(2) One of them is to be connected to the alternative DP control system		
(3) One of them is to be connected to the backup DP control system (see (5.2.4) and Table 3)		

**10.2.9** The main DP control system is to provide online capability plots and online simulation of the position holding capabilities for the most relevant failure modes. These functionalities are to be verified as far as feasible by full scale testing during sea trials.

### 10.3 Position reference system

**10.3.1** At least four independent position reference systems are required (see Tab 8). They are to be designed and so arranged as to ensure that three of them are to be continuously available during DP operations.

**10.3.2** The position reference systems are to be based on two different techniques and a minimum of two Global Navigation Satellite Systems (GNSS) are required. At least one of the GNSS is to be equipped to receive two distinct signal frequencies.

**10.3.3** Position reference systems are to be independent of each other and supplied from UPSs. Their power supply and interface with DP control systems are to be in accordance with the redundancy requirements but at least one position reference system is to be directly interfaced to the alternative DP control system (DP Class 2) or backup DP control system (DP class 3).

**10.3.4** Position reference systems can be interfaced to both DP control systems provided that the failure of a position reference system does not jeopardize the independence requirement between the main and alternative DP control systems.

### 10.4 Other vessel sensors

**10.4.1** At least four vertical reference systems and four gyrocompasses are required (see Tab 8). Two of them are to be based on two different measurement techniques.

**10.4.2** At least four wind sensors are required (see Tab 8). Two of them are to be based on two different measurement techniques.

**10.4.3** Sensors are to be supplied from UPSs. Their power supply and interface with DP control systems are to be in accordance with the redundancy requirements but at least one sensor of each type is to be directly interfaced to the alternative DP control system (DP Class 2) or backup DP control system (DP class 3).

**10.4.4** Sensors can be interfaced to both DP control systems provided that the failure of a sensor does not jeopardize the independence requirement between the main and alternative DP control systems.

## 11 Digital DP survey

### 11.1 General

**11.1.1** The requirements of the present Article apply to ships fitted with a system which independently collects data from the DP system as described within this Article and makes the data available in a readable format in order for the correct functionality of the DP system to be validated and verified by the Society digitally from an onshore location during Class surveys.

**11.1.2** Prior to using the system for digital verification, according to figure 2, the system as described in [11.1.1] is to be validated, according to figure 1, ensuring that evidence produced by the system likely corresponds accurately to the real behavior of the DP system.

**11.1.3** Ships fitted with a system in compliance with [11.1.1] and [11.1.2], may be granted the notation **DDPS** as per [1.4.8].

### 11.2 Definitions

#### 11.2.1 Assessment

Assessment means the action or an instance of making a judgment about something.

#### 11.2.2 Data

Data means the facts and statistics collected together for reference or analysis.

### 11.2.3 Data completeness

Data completeness means, referring to ISO 8000-2, having all the data that existed in the possession of the sender at the time the data message was created. It also means the extent to which the relevant data sets, the expected records of a data set, and data elements, attributes and values in a data set are provided and reflect the scope and the real world.

### 11.2.4 Data quality

Data quality means the degree of quality that data is fit for its intended uses in operations, decision making and planning.

### 11.2.5 Digital Information Management System

Digital Information Management System (DIMS) means a software function that helps organize and analyze data. The purpose of an information system is to turn raw data, generated by tests typically performed by crew guided by a class approved programme, into useful information that can be used for verification and validation of survey tests by the Society.

### 11.2.6 Digital Survey System

Digital Survey System (DSS) means a system enabling data from the DP system to be collected, treated and visualized, for the purpose of digitally validating and verifying the correct functionality of the DP system. Typically the DSS consists of the DIMS, fitted on the vessel, and the Digital Survey Visualization Application (DSVA), which can be used on the vessel as well as onshore.

### 11.2.7 Digital Survey Visualization Application

Digital Survey Visualization Application (DSVA) means a software application which visualizes recorded parameters and functionalities of the DP system. The DSVA is to have a facility for the owner to request verification from the society and for the society to provide the result of the verification to the owner.

### 11.2.8 Evidence

Evidence means the available body of facts or information indicating whether test results are true or valid.

### 11.2.9 Evidence quality

Evidence quality reflects the extent to which confidence is put in the evidence supporting test results.

### 11.2.10 Raw data

Raw data means data collected as time series that can be linked to related tests, creating a relationship between collected data and the timeframe during which a particular test has been carried out.

### 11.2.11 Remote access

Remote access is the ability to access a computer or a network remotely through a network connection. Remote access enables users to access the systems they need when they are not physically able to connect directly; in other words, users access systems remotely by using a telecommunications or internet connection.

### 11.2.12 Test tension

Test session means a time period defined by a start and end time during which a test on a system or single piece of equipment is conducted.

### 11.2.13 Time stamped

Time stamped means to mark something with a printed or digital record of when something happened or was done.

## 11.3 Documentation and test attendance

**11.3.1** In addition to the drawings and specifications required by the documents listed in Tab 1, the additional documents listed in Tab 9 are required.

**11.3.2** The tests to be performed and witnessed for the acceptance of the DSS are listed in Pt C, Ch 3, Sec 3, Tab 2, and are to be in accordance with requirements for Cat II/III systems.

## 11.4 Recorded parameters

**11.4.1** The data gathered and used as evidence is to be in the form of system generated data, i.e. trending (time series) of system parameters (see Tab 10) and functionalities (see-Tab 11), which are recorded as individual test sessions which include as a minimum a start and end time for each session. In addition, it may be accepted that some data cannot be automatically gathered by the DIMS requiring the evidence for that particular test session to be based on screen captures, pictures and/or videos.

**11.4.2** When evidence is based on screen captures, pictures and/or videos, these is to be delivered as digital files, date and time stamped, whereby the date and time corresponds to the date and time that the test session, for which this evidence is submitted, is conducted. Vessel owner is to also have procedures in place, approved by the Society, to guarantee that evidence of this kind is genuine.

**11.4.3** The parameters to be recorded by the DIMS are detailed in Tab 10. This list is the minimum required list of parameters necessary to enable digital surveys to be conducted.

**11.4.4** The functionality as described in Tab 11 is to be able to be recorded.

## 11.5 Data Communication and Management

### 11.5.1 Data storage

The DIMS is to record all the parameters and functionality as per Tab 10 and Tab 11 while the system is in an active state, and store this data for at least a period covering four Annual surveys and a Class Renewal survey.

**11.5.2** Data quality assurance is the process of data profiling to discover inconsistencies and other anomalies in the data. The vessel owner is to have physical and logical security measures in place to prevent unauthorized or unintentional modification of software, whether undertaken at the physical system or remotely.

**Table 9 : Documents to be submitted**

No	I/A (1)	Documents to be submitted
1	A	Functional description of the DSS
2	A	List of DSS units/components (Original Equipment Manufacturer (OEM), type, etc.)
3	A	Single line diagram of the supply and monitoring of DIMS
4	A	Description of the internal and external communication protocols
5	I	Risk analysis demonstrating that failures of DIMS have no effect on the DP control system, including the network storm protection of DIMS
6	I	Data access procedures
7	A	Data storage procedures
8	A	Data treatment procedures
9	A	Programme of the vessel's DP tests including associated data points for data validation
10	A	Programme of the vessel's DP tests including associated data points for data verification
11	A	Test programme of the DSS for integration
12	I	Data transfer procedures
13	A	List of standards used for data communication links
14	A	Diagrams/Description of DSVA, if not included in the functional description of DSS (Item 1)
15	A	Specification of cables between the vessel's DP system equipment and the DIMS
16	I	Operating manual of the DSS
17	A	Specification of the data manipulation prevention measures
18	A	Specification of alarm list filters if utilised
19	A	Specification of signal segregation in case signals cross redundancy zones (2)
20	A	Procedures detailing how failures are simulated or signals are failed for each test, including how the system is restored after a failure (if not detailed in data treatment procedures in Item 8)
<p>(1) A: To be submitted for approval I: To be submitted for information</p> <p>(2) For symbol RS only</p>		

**Table 10 : Parameters to be recorded**

Item	Parameters to be recorded	Alarms or group of alarms	Indication/Measured values
1	Ship coordinates and desired position		X
2	Actual position		X
3	Deviation from the desired operating area outside the a.m. limits		X
4	DP setup including: (3) <ul style="list-style-type: none"> <li>• power distribution overview for main power and standby power</li> <li>• operational status of all environmental reference sensors</li> <li>• operational status of all position reference sensors</li> <li>• engine configuration</li> <li>• thruster configuration</li> <li>• pump configurations on all fuel oil systems associated with the DP system</li> <li>• pump configuration on all lubrication oil systems associated with the DP system</li> <li>• pump configuration on all cooling water systems associated with the DP system</li> <li>• pump configuration on all hydraulic systems associated with the DP system</li> <li>• DP Class as set in the DP system.</li> </ul>		X
5	Thruster availability ready for operation		X
6	Thruster in operation		X
7	Thruster failure (this includes thruster controllers and pumps)	X	
<p><b>Note 1:</b> Depending on the DP classification notation required, the above-mentioned list may be simplified.</p> <p>(1) Only if applicable, as ESD functionality might not be installed on every DP vessel.</p> <p>(2) Applicable only if the mission-related equipment is connected or has an impact on the DP system.</p> <p>(3) This can take the form of a clear GUI showing the status of the specified equipment during each test session.</p>			

Item	Parameters to be recorded	Alarms or group of alarms	Indication/Measured values
8	Thruster command and feedback failures	X	X
9	Thruster emergency stop functionality	X	X
10	Thruster emergency stop failures	X	
11	Vectorial thrust output outside limit	X	X
12	Total output of all thrusters		X
13	Thrust limitation by available power	X	X
14	Power supply failure	X	
15	Power management failure	X	
16	Desired heading		X
17	Actual heading		X
18	Deviation from desired heading	X	X
19	Failure of any heading reference system	X	X
20	Automatic switching to standby heading reference system		X
21	Failure of the vertical reference sensor measuring the pitching and rolling of the unit	X	X
22	Automatic switching to vertical standby reference sensor		X
23	Indication of wind speed and direction sensor	X	X
24	Wind sensor failure, speed and direction	X	X
24	Automatic switching of wind speed and direction sensor		X
26	Computer/Controller failures	X	X
27	Automatic switching to standby computer/controller	X	X
28	Abnormal input signals to the computer/controller, analogue input failures	X	
29	Position reference system failure	X	X
30	Position reference system indication		X
31	Automatic start/switch on of a standby power generation device		X
32	Functionality of the DP joystick		X
33	Operational status of each network		X
34	Network failure	X	X
35	Operator station functionality for each operator station		X
36	Operator station failures for each operator station	X	X
37	Command transfer functionality between operator stations		X
38	Functionality of the independent joystick		X
39	Unavailability of the independent joystick	X	X
40	Two-way voice functionality between key DP equipment rooms		X
41	UPS/Battery system failures	X	X
42	Automatic switching to battery power on loss of main power for each UPS/Battery system		X
43	30 minutes of battery power on loss of main supply for each UPS/Battery system	X	X
44	Power generation device load sharing functionality		X
45	Power generation device load sharing failures	X	X
46	Power generation auxiliary equipment failures	X	X
47	Sea water cooling circuit failures	X	X
48	Fresh water cooling circuit failures	X	X
49	Compressed air failures	X	X
49	Power management input failure	X	
49	ESD controller and circuits failures (1)	X	
50	Mission-related equipment (2) failures	X	

**Note 1:** Depending on the DP classification notation required, the above-mentioned list may be simplified.

(1) Only if applicable, as ESD functionality might not be installed on every DP vessel.

(2) Applicable only if the mission-related equipment is connected or has an impact on the DP system.

(3) This can take the form of a clear GUI showing the status of the specified equipment during each test session.

**Table 11 : Functionality to be recorded**

Item	Functionality	Alarms or group alarms	Indication/Measured values
1	Consequence analysis as per [1.2.6]	X	X
2	Mathematical model as per [2.2.1]	X	X
3	Load rejection as per [4.2.9]		X
4	Load acceptance as per [4.2.9]		X
5	Power demand as per [4.2.7]		X

**11.5.3** Access to the DSVA is to be password protected and all operators, crew members conducting tests, surveyors reviewing tests, etc., are to be identified, as a minimum with name and position, when logged in. Each test is to be digitally signed when completed by an onboard authorized signature. Each test is to be digitally signed when verified by class, by the class surveyor.

**11.5.4** It is to be possible to run DSS both in connected (to e.g. application provider and/or the Society) and in offline mode. When verification data is collected in offline mode the results are to be uploaded automatically when the system becomes connected again.

**11.5.5** If the DSVA is used on a device on the vessel, which communicates wirelessly with the DIMS on the vessel, the system is to comply with the radio frequency and power level requirements of International Telecommunication Union and flag state requirements. Consideration should be given to system operation in the event of port state and local regulations that pertain to the use of radio-frequency transmission prohibiting the operation of a wireless data communication link due to frequency and power level restrictions.

**11.5.6** For wireless data communication equipment, tests during harbour and sea trials are to be conducted to demonstrate that radio-frequency transmission does not cause failure of any equipment and does not self-fail as a result of electromagnetic interference during expected operating conditions.

**11.5.7** A clear warning is to be displayed when important boxes, such as the name box for the test operator or boxes for completion of a test step, are not filled upon ending a test session.

**11.5.8** The data link between the DIMS and the monitored equipment is to be self-checking, detecting failures on the link itself and data communication failures on nodes connected to the link. Detected failures are to initiate an alarm.

**11.5.9** The logical map of networks, for both the system on the vessel as well as any shore based system, is part of the software registry. The Logical Map focuses on the logical topology of networks (e.g. IP and non-IP addressing scheme, subnet names, logical links, principal devices in operation, etc.). This map can be organized in the form of inventories and a diagram.

### 11.5.10 Logical inventories

List of IP address ranges with, for each one:

- the list of switches concerned
- the functional description of the IP range
- the list of Dynamic Host Configuration Protocol (DHCP) servers, relevant IP address management plan and IP history re-cording policy
- the list of equipment MAC address
- interconnections with other ranges
- flow matrix with source, destination, ip, ports, service, motivation, roles, volume estimation and time windows if any.

List of non-IP networks with, for each network:

- the list of MAC addresses or addresses specific to the industrial protocols on the network
- the list of switches concerned
- functional description of the network
- devices connected to other networks (connectors).

List of non-Ethernet access points with, for each one:

- the list of access ports
- addressing, if there is a special protocol
- the list of connected devices.

List of logical servers and desktops with, for each one, if applicable:

- IP addressing (network, mask, gateway)
- operating system version
- underlying physical server
- applications and their versions
- services and versions.

List of connectors and communicating field devices (remote I/O, sensors, actuators, etc.) with, for each one:

- IP addressing (network, mask, gateway), the associated MAC addressing and network or the specific addressing, if appropriate
- applications
- unit of measurement
- type of data.

## 11.6 Hardware requirements

**11.6.1** The DIMS on the vessel is to be continuously powered and is to have an automatic change-over to a stand-by power supply in the case of loss of normal power, so that tests on the vessel's power supply do not adversely affect the recording of data.



**11.6.2** All cabling between the DIMS and the various components of the DP system are to be in compliance with I [6.1].

**11.6.3** The data network architecture is to be capable of performing according to the required availability level. Hardware installed onboard is to be able to perform according to applicable conditions where it is installed, and any applicable limitations are to be documented.

**11.6.4** Hardware connecting devices are to be chosen, when possible, in accordance with international standards.

**11.6.5** Any coupling devices are to be designed, as far as practicable, so that in the event of a single fault, they do not alter the network function. When a failure occurs, an alarm is to be activated. Addition of coupling devices is not to alter the network function.

## 11.7 Cyber security

**11.7.1** A DSS accepted according to this Article is to also comply with the cyber security requirements, including remote access, as per NR659.

**11.7.2** The remote access method is to be approved by the Society on a case-by-case basis.

**11.7.3** Prior to installation, all artefacts, software code, executables and the physical medium used for installation on the vessel are to be scanned for viruses and/or malicious software. Results of the scan are to be documented and kept with the software registry. Barriers, either hardware or software, are to be implemented to ensure the integrity of the DIMS, and the systems it is connected to, and prevent the connection of unauthorised or unapproved devices or systems until such devices are scanned for viruses and/or malicious software.

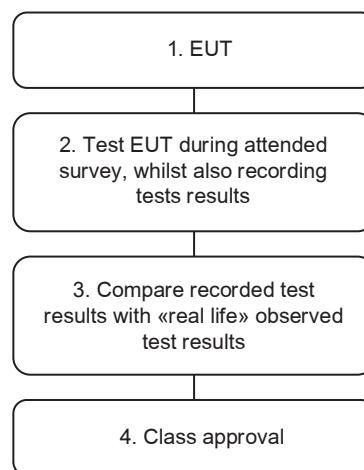
## 11.8 Validation

**11.8.1** Validation can be performed as part of the FMEA proving trials (see [1.2.13]), and serves to prove that recorded parameters (see Tab 10) and functionalities (see Tab 11), and the presentation (see Tab 12), correspond to the real life behavior of the DP system. Validation of the recorded parameters is therefore always to be performed and witnessed on the vessel by the Society.

**11.8.2** The validation program, detailing all tests and monitored data points is to be submitted to the Society prior to the onboard tests and is to be approved.

**11.8.3** The validation process is detailed in Fig 1.

**Figure 1 : Validation process**



**11.8.4** During the validation process, evidence is to be delivered in such a way that the Society can assess that the test(s) has been executed in the right manner and that the evidence is complete and genuine. This includes ensuring that the test is applied in the right manner to the equipment/system, when in the correct mode, and the ability to validate that the recorded result likely corresponds accurately to the real world.

**11.8.5** The DSS integration tests, as specified and conducted by the OEM, and the validation tests, as specified in the program of the vessel's DP tests including associated data points for data validation, is to be witnessed by the Society.

## 11.9 Verification

**11.9.1** For any digital verification method to be accepted the method must be able to provide relevant, genuine and trustworthy results to the Society in order for the Society to be able to objectively assess whether the DP system meets the single failure criteria for its corresponding class notation. This includes ensuring that the test is applied in the right manner to the equipment/system, and in the correct mode.

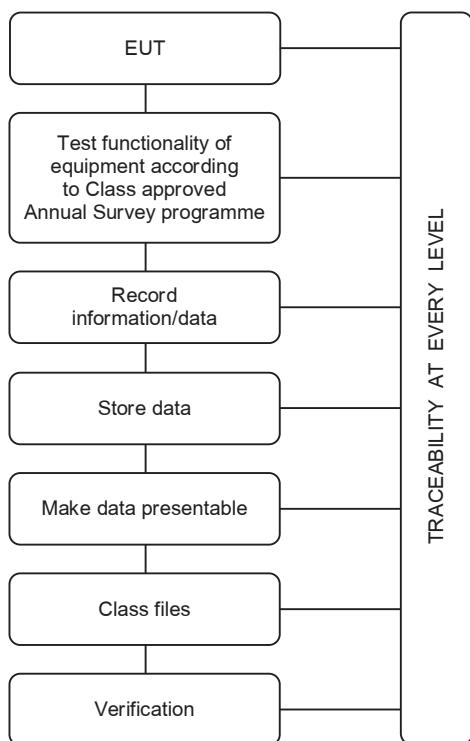
**11.9.2** Evidence generated by a digital verification method complying with the requirements within this notation, can upon request, be accepted as additional to, or replacing evidence generated from the attended survey activities as required by the applicable class notation rules.

**11.9.3** In case the digital verification method will not be able to fully generate evidence regarding the status of the system, the digital verification method may be used in combination with an attended survey in order to provide sufficient verification coverage.

**11.9.4** Approval that the new digital verification method complies with the requirements within this Article, is to be on a case-by-case basis.

**11.9.5** The verification process, to establish whether the DP system meets regulatory or technical standards, is detailed in Fig 2.

**Figure 2 : Verification process**



**11.9.6** Each test session (see [11.4.1]) is to generate a class file containing all activity and results - such as operator inputs as control commands, equipment disconnected or disabled, simulated failures, system direct response as alarms and feedbacks, and system indirect response as a loss of position and heading - during the time stamped session, which is to be submitted to the Society. As a minimum, the items as specified in Tab 12 are to be displayed via the DSVA.

**11.9.7** All test sessions are to be concluded and witnessed by the society, either on board or remotely, within the window of the survey scheme applicable to the vessel.

**11.9.8** The DSVA is to have functionality for:

- Identifying which class files have been submitted to the Society and keep record of which results are accepted or not. The format, scope and frequency used for delivering the class files to the Society, is to be agreed upon and approved by the Society.
- Displaying at a minimum the parameters and configurations as defined in Tab 12, for each test session.
- Playback of each test session, with allowance for play, pause, wind and rewind, whereby it is possible to observe the system response from normal system operation to a failed state and vice versa.

**Table 12 : Parameters and configurations to be displayed**

Parameters and configurations	Static	Dynamic
Date and time when the test session is conducted	X	
Graphical representation of the vessel and position		X
DP set up (including DP Class setting, Power Distribution setup, pump setup, etc.)	X	X
Status for all position reference sensors (1)		X
Status for all environmental sensors (1)	X	X
Heading data		X
Power generation parameter data		X
Thruster representation (including rotation, percentage thrust and order/feedback)		X
Wind speed and direction (2)	X	X
Calculated sea current speed and direction (2)	X	X
Alarms - text and colour (1)		X
Name box for crew member conducting the test (3)	X	
Name box for class surveyor	X	
Comment box or other facility for the test operator to leave an explanation, as to why, in case a test is aborted, unsuccessful or for any other reason not completed in the intended manner, linked to the unsuccessful attempt	X	
<p><b>Note 1:</b> Depending on the DP classification notation required and the complexity of the vessel, the above-mentioned list may be simplified</p> <p>(1) Status is to indicated Normal, Warning and Alert states</p> <p>(2) Speed and direction of the wind and sea current may either be dynamically or statically displayed</p> <p>(3) This could be connected to the login when accessing the DSVA to record a test.</p>		

**11.9.9** The Society is to also have access to the raw data produced from each test session, i.e. the original test data from the vessel.

**11.9.10** Independent of the class files send to the Society, the vessel owner is to keep, and make accessible to the Society, updated records of the verification status of the complete DP system, i.e. for each item to be verified, information on what, how and when verification has been performed and the corresponding status/results.

**11.9.11** The DIMS, DSVA and vessel DP FMEA is to be kept up to date in order to reflect any changes made to the DP system or DP system technical operating modes. Therefore a system is to be in place for change management related to software versions and changes in system parameters. This change management procedure also applies to any changes made to the functionality or the firmware of DIMS and/or the DSVA.

**11.9.12** It is accepted that the vessel will undergo DP tests involving activities which are outside the scope of class. Based on owner's request and specific agreements the Society may assist in assessment also of this scope.

## 11.10 Qualification

**11.10.1** All verification activities requiring manual operations to perform the test(s), i.e. crew performing the test rather than the system collecting data automatically such as in the case of generator temperature readings, is to be executed by qualified personnel on the vessel.

**11.10.2** An Owner's attestation, confirming that the Dynamic Positioning Officer (DPO), Chief Engineer (CE) and/or Electro Technical Officer (ETO) are duly qualified to carry out the tests in the Annual Survey program is to be made available to the Society.

**11.10.3** Where the test results as tested by the Dynamic Positioning Officer (DPO), Chief Engineer (CE) and/or Electro Technical Officer (ETO) do not correspond to the findings of the attending Surveyor, or in case of doubt on the results, the Society may request the Owner to withdraw the qualification attestation of the person carrying out the test(s) until further training and re-assessment of his/her qualification.

## SECTION 7 VAPOUR CONTROL SYSTEM (VCS)

### 1 General

#### 1.1 Application

**1.1.1** The additional class notation **VCS** is assigned, in accordance with Pt A, Ch 1, Sec 2, [6.14.7], to ships fitted with systems for control of vapour emission from cargo tanks complying with the requirements of this Section.

The notation **TRANSFER** is added to the notation **VCS** for ships fitted with systems for control of vapour emission from cargo tanks to another ship and vice versa. Additional requirements for the additional notation **TRANSFER** are given in Article [6].

**1.1.2** As a rule, this notation is applicable to ships which are assigned one or more of the following class notations:

- oil tanker
- chemical tanker
- FLS tanker
- liquefied gas carrier
- combination carrier/OOC
- combination carrier/OBO.

#### 1.2 Definitions

##### 1.2.1 Diluted

A flammable gas or mixture is defined as diluted when its concentration in air is less than 50% of its lower explosive limit.

##### 1.2.2 Flammable cargoes

Flammable cargoes are crude oils, petroleum products and chemicals having a flashpoint not exceeding 60 °C (closed cup test) and other substances having equivalent fire risk.

##### 1.2.3 Inerted

Inerted is the condition in which the oxygen content in a flammable gas/air mixture is 8% or less by volume.

##### 1.2.4 Independent

Two electrical systems are considered independent when any one system may continue to operate with a failure of any part of the other system, except the power source and electrical feeder panels.

##### 1.2.5 Lightering operation

Lightering operation is the operation of transferring liquid cargo from one ship to one service ship.

##### 1.2.6 Maximum allowable transfer rate

Maximum allowable transfer rate is the maximum volumetric rate at which a ship may receive cargo or ballast.

##### 1.2.7 Service ship

Service ship is a ship which receives and transports liquid cargoes between a facility and another ship and vice versa.

##### 1.2.8 Ship vapour connection

The ship vapour connection is the point of interface between the ship's fixed vapour collection system and the collection system of a facility or another ship. Hoses or loading arms on board, carried for the purpose of these Rules, are considered part of the vapour control system of the ship.

##### 1.2.9 Terminal vapour connection

The terminal vapour connection is that point at which the terminal vapour collection system is connected to a vapour collection hose or arm.

##### 1.2.10 Topping-off operation

Topping-off is the operation of transfer of liquid cargo from a service ship to another ship in order to load the receiving ship at a deeper draft.

##### 1.2.11 Vapour balancing

Vapour balancing is the transfer of vapour displaced by incoming cargo from the tank of a ship receiving cargo into a tank of a facility delivering cargo via a vapour collection system.

##### 1.2.12 Vapour collection system

The vapour collection system is an arrangement of piping and hoses used to collect vapour emitted from a ship's cargo tank and to transport the vapour to a vapour processing unit.

##### 1.2.13 Vapour processing unit

Vapour processing unit is that component of a vapour control system that recovers or destroys vapour collected from a ship.

### 1.3 Documentation to be submitted

**1.3.1** Tab 1 lists the documents which are to be submitted.

## 2 Vapour system

### 2.1 General

#### 2.1.1 Installation of vapour collection system

- a) Each ship is to have vapour collection piping permanently installed, with the tanker vapour connection located as close as practical to the loading manifolds.
- b) In lieu of permanent piping, chemical tankers may have vapour connections located in the vicinity of each cargo tank in order to preserve segregation of the cargo systems.

Table 1 : Documents to be submitted

No.	A/I (1)	Document
1	A	Diagrammatic plan of the vapour piping system including: <ul style="list-style-type: none"> <li>• material specifications</li> <li>• dimensions, scantlings and sizes</li> <li>• ratings (temperature/pressure)</li> <li>• joining details</li> <li>• fittings and standards used</li> </ul>
2	A	Diagrammatic drawing of the gauging system and overfill protection including: <ul style="list-style-type: none"> <li>• Manufacturer and type of the instruments</li> <li>• plan of hazardous area locations</li> <li>• location of electrical equipment in gas-dangerous spaces and safe certificates of the electrical instruments intended to be used in hazardous locations</li> <li>• electrical schemes concerning the alarm system supply</li> <li>• electrical schemes concerning the intrinsically safe circuits</li> </ul>
3	A	Diagrammatic drawings of the venting system, including necessary data for verifying the venting capacity of the pressure/vacuum valves
4	I	Pressure drop calculations comparing cargo transfer rates versus pressure drops from the farthest tanks to the vapour connection, including any possible hoses
5	I	Calculations showing the time available between alarm setting and overfill at maximum loading rate for each tank
6	A	Instruction manual
7	I	Information on the anti-detonation devices, including Manufacturer and type of the device employed as well as documentation on any acceptance tests carried out, only for ships for which the notation <b>TRANSFER</b> is requested
(1) A : to be submitted for approval I : to be submitted for information.		

### 2.1.2 Incompatible cargoes

If a tanker simultaneously collects vapour from incompatible cargoes, it is to keep these incompatible vapours separate throughout the entire vapour collection system.

### 2.1.3 Liquid condensate disposal

Means are to be provided to eliminate liquid condensate which may collect in the system.

### 2.1.4 Electrical bonding

Vapour collection piping is to be electrically bonded to the hull and is to be electrically continuous.

### 2.1.5 Inert gas supply isolation

When inert gas distribution piping is used for vapour collection piping, means to isolate the inert gas supply from the vapour collection system are to be provided. The inert gas main isolating valve required in Pt C, Ch 4, Sec 15, [13.3.2] may be used to satisfy this requirement.

### 2.1.6 Prevention of interference between vapour collection and inert gas systems

The vapour collection system is not to interfere with the proper operation of the cargo tank venting system. However, vapour collection piping may be partly common with the vent piping and/or the inert gas system piping.

### 2.1.7 Flanges

- Bolt hole arrangement of vapour connection flanges to the terminal is to be in accordance with Tab 2.
- Each vapour connection flange is to have permanently attached 12,7 mm diameter studs protruding out of the flange face for at least 25,4 mm.
- The studs are to be located at the top of the flange, midway between bolt holes and in line with bolt hole patterns.

## 2.2 Vapour manifold

### 2.2.1 Isolation valve

- An isolation valve capable of manual operation is to be provided at the ship vapour connection.
- The valve is to have an indicator to show clearly whether the valve is in the open or closed position, unless the valve position can be readily determined from the valve handle or valve stem.

### 2.2.2 Labelling

The vapour manifold is to be:

- for the last 1 m painted red/yellow/red, with the red bands 0,1 m wide and the yellow band 0,8 m wide
- labelled "VAPOUR" in black letters at least 50 mm high.

**Table 2 : Bolting arrangement of connecting flanges**

Pipe nominal diameter (mm)	Outside diameter of flange (mm)	Bolt circle diameter (mm)	Bolt hole diameter (mm)	Bolt diameter (mm)	Number of bolts
≤ 12,70	88,90	60,45	15,75	12,70	4
≤ 19,05	98,55	69,85	15,75	12,70	4
≤ 25,40	107,95	79,25	15,75	12,70	4
≤ 31,75	117,35	88,90	15,75	12,70	4
≤ 38,10	127,00	98,55	15,75	12,70	4
≤ 50,80	152,40	120,65	19,05	15,87	4
≤ 63,50	177,80	139,70	19,05	15,87	4
≤ 76,20	190,50	152,40	19,05	15,87	4
≤ 88,90	215,90	177,80	19,05	15,87	8
≤ 101,60	228,60	190,50	19,05	15,87	8
≤ 127,00	254,00	215,90	22,35	19,05	8
≤ 152,40	279,40	241,30	22,35	19,05	8
≤ 203,20	342,90	298,45	22,35	19,05	8
≤ 254,00	406,40	361,95	25,40	22,22	12
≤ 304,80	482,60	431,80	25,40	22,22	12
≤ 355,60	533,40	476,25	28,45	25,40	12
≤ 406,40	596,90	539,75	28,45	25,40	16
≤ 457,20	635,00	577,85	31,75	28,54	16
≤ 508,00	698,50	635,00	31,75	28,57	20
≤ 609,60	749,30	749,30	35,05	31,75	20

## 2.3 Vapour hoses

### 2.3.1 Hoses

Each hose used for transferring vapour is to have:

- a design burst pressure of at least 0,175 MPa
- a maximum working pressure of at least 0,035 MPa
- the capability of withstanding at least 0,014 MPa vacuum without collapsing or constricting
- electrical continuity with a maximum resistance of 10000 Ω
- resistance to abrasion and kinking
- the last 1 m of each end of the hose marked in accordance with [2.2.2].

For hose flanges see [2.1.7].

### 2.3.2 Handling equipment

Vapour hose handling equipment is to be provided with hose saddles which provide adequate support to prevent kinking or collapse of hoses.

## 2.4 Vapour overpressure and vacuum protection

### 2.4.1 General

The cargo tank venting system is:

- a) to be capable of discharging cargo vapour at 1,25 times the maximum transfer rate in such a way that the pressure in the vapour space of each tank connected to the vapour collection system does not exceed:
  - 1) the maximum working pressure of the tank
  - 2) the operating pressure of a safety valve or rupture disk, if fitted
- b) not to relieve at a pressure corresponding to a pressure in the cargo tank vapour space of less than 0,007 MPa
- c) to prevent a vacuum in the cargo tank vapour space that exceeds the maximum design vacuum for any tank which is connected to the vapour collection system, when the tank is discharged at the maximum rate
- d) not to relieve at a vacuum corresponding to a vacuum in the cargo tank vapour space less than 0,0035 MPa below the atmospheric pressure.

### 2.4.2 Pressure/vacuum safety valves

- a) Pressure/vacuum safety valves are to be fitted with means to check that the device operates freely and does not remain in the open position.
- b) Pressure relief valves are to be fitted with a flame screen at their outlets, unless the valves are designed in such a way as to ensure a vapour discharge velocity of not less than 30 m/second.

### 3 Instrumentation

#### 3.1 Cargo tank gauging equipment

**3.1.1** Each cargo tank that is connected to a vapour collection system is to be equipped with a cargo gauging device which:

- provides a closed gauging arrangement which does not require opening the tank to the atmosphere during cargo transfer
- allows the operator to determine the liquid level in the tank for the full range of liquid levels in the tank
- indicates the liquid level in the tank, at the position where cargo transfer is located
- if portable, is installed on tank during the entire transfer operation.

#### 3.2 Cargo tank high level alarms

##### 3.2.1 General

- a) Each cargo tank that is connected to a vapour collection system is to be equipped with an intrinsically safe high level alarm system which alarms before the tank overfill alarm, but not lower than 95% of the tank capacity.
- b) The high level alarm is to be identified with the legend "HIGH LEVEL ALARM" and have audible and visible alarm indications that can be seen and heard where the cargo transfer is controlled.

##### 3.2.2 Alarm characteristics

The high level alarm is:

- to be independent of the overfill alarm
- to alarm in the event of loss of power to the alarm system or failure of the electric circuits to the tank level sensors
- to be able to be checked at the tank for proper operation prior to each transfer or contain an electronic self-testing feature which monitors the condition of the alarm circuits and sensors.

#### 3.3 Cargo tank overfill alarms

##### 3.3.1 General

- a) Each cargo tank that is connected to a vapour collection system is to be equipped with an intrinsically safe overfill alarm which alarms early enough to allow the person in charge of transfer operation to stop such operation before the cargo tank overflows.
- b) The overfill alarm is to be identified with the legend "OVERFILL ALARM" and have audible and visible alarm indications that can be seen and heard where the cargo transfer is controlled and in the deck cargo area.

##### 3.3.2 Alarm characteristics

The overfill alarm is:

- to be independent of both the high level alarm (see [3.2.1]) and the cargo gauging system (see [3.1])
- to alarm in the event of loss of power to the alarm system or failure of the electric circuits to the tank level sensors
- to be able to be checked at the tank for proper operation prior to each transfer or contain an electronic self-testing feature which monitors the condition of the alarm circuits and sensors.

#### 3.4 High and low vapour pressure alarms

##### 3.4.1 Pressure alarms

Each vapour collection system is to be fitted with one or more pressure sensing devices that sense the pressure in the main collection line, and which:

- have a pressure indicator located where the cargo transfer is controlled
- alarm the high pressure at not more than 90% of the lowest relief valve setting in the tank venting system
- alarm at a low pressure of not less than 100 mm WG for an inerted tank, or the lowest vacuum relief valve setting in the cargo venting system for a non-inerted tank.

##### 3.4.2 Equivalence

Pressure sensors fitted in each cargo tank are acceptable as equivalent to pressure sensors fitted in each main vapour collection line.

### 4 Instruction manual

#### 4.1 General

##### 4.1.1

- a) Each ship utilizing a vapour emission control system is to be provided with written operational instructions covering the specific system installed on the ship.
- b) Instructions are to encompass the purpose and principles of operation of the vapour emission control system and provide an understanding of the equipment involved and associated hazards. In addition, the instructions are to provide an understanding of the operating procedures, piping connection sequence, start-up procedures, normal operations and emergency procedures.

#### 4.2 Content

##### 4.2.1 The instructions are to contain:

- a) a line diagram of the tanker's vapour collection piping including the location of all valves, control devices, pressure-vacuum safety valves, pressure indicators, flame arresters and detonation arresters, if fitted

- b) the maximum allowable transfer rate for each group of cargo tanks having the same venting line, determined as the lowest of the following:
- 1) 80% of the total venting capacity of the pressure relief valves in the cargo tank venting system
  - 2) the total vacuum relieving capacity of the vacuum relief valves in the cargo tank venting system
  - 3) the rate based on pressure drop calculations at which, for a given pressure at the facility vapour connection, or, if lightering, at the vapour connection of the service ship, the pressure in any cargo tank connected to the vapour collection system exceeds 80% of the setting of any pressure relief valve in the cargo tank venting system
- c) the initial loading rate for each cargo tank, to be determined in such a way as to minimise the development of a static electrical charge, when applicable
- d) tables or graphs of transfer rates (and corresponding vapour collection system pressure drops through the vapour hoses, if foreseen) determined from the most remote cargo tanks to the ship vapour connection as follows:
- 1) for each cargo handled by the vapour collection system at the maximum and the lowest transfer rates
  - 2) based on 50% cargo vapour and air mixture, and a vapour growth rate appropriate for the cargo being loaded
- e) the safety valve setting at each pressure-vacuum safety valve.

## 5 Testing and trials

### 5.1

#### 5.1.1 General

Machinery and equipment which are part of the vapour collection system are to be tested in compliance with the applicable requirements of the various Sections of the Rules.

#### 5.1.2 Hydrostatic tests

Pressure parts are to be subjected to hydrostatic tests in accordance with the applicable requirements.

#### 5.1.3 Pressure/vacuum valves

Pressure/vacuum valves are to be tested for venting capacity. The test is to be carried out with the flame screen installed if contemplated in accordance with [2.4.2].

### 5.2 Shipboard trials

5.2.1 Upon completion of construction, in addition to conventional sea trials, specific tests may be required at the Society's discretion in relation to the characteristics of the plant fitted on board.

## 6 Additional requirements for notation "TRANSFER"

### 6.1 Application

6.1.1 These requirements are applicable to service ships.

### 6.2 Equipment

#### 6.2.1 Ships with inerted cargo tanks

If the cargo tanks on a ship discharging cargo and a ship receiving cargo are inerted, the service ship is to have means to inert the vapour transfer hose prior to transferring cargo vapour and an oxygen analyzer with a sensor or sampling connection fitted within 3 m of the ship vapour connection which:

- activates an audible and visual alarm at a location on the service ship where cargo transfer is controlled when the oxygen content in the vapour collection system exceeds 8% by volume
- has an oxygen concentration indicator located on the service ship where the cargo transfer is controlled
- has a connection for injecting a span gas of known concentration for calibration and testing of the oxygen analyser.

#### 6.2.2 Ships with cargo tanks not inerted

If the cargo tanks on a ship discharging cargo are not inerted, the vapour collection line on the service ship is to be fitted with a detonation arrester located within 3 m of the ship vapour connection.

#### 6.2.3 Electrical insulating flange

An electrical insulating flange or one length of non-electrically conductive hose is to be provided between the ship vapour connection on the service ship and the vapour connection on the ship being lightered.



## SECTION 8

## COFFERDAM VENTILATION (COVENT)

### 1 General

#### 1.1 Application

**1.1.1** The additional class notation **COVENT** is assigned, in accordance with Pt A, Ch 1, Sec 2, [6.14.8], to ships having all cofferdams in the cargo area provided with fixed ventilation systems complying with the requirements of this Section.

**1.1.2** For the purpose of this Section, the cargo area is that portion of the ship included between the forward bulkhead of the machinery space and the collision bulkhead.

In the case of ships with machinery spaces located amidships, the cargo area is also to include that portion of the ship between the aft bulkhead of the engine space and the after peak bulkhead, excluding the shafting tunnel.

#### 1.2 Documents to be submitted

**1.2.1** The documents listed in Tab 1 are to be submitted to the Society for approval.

The Society reserves the right to require additional plans or information in relation to the specific characteristics of the installations.

### 2 Design and construction

#### 2.1 Arrangement

##### 2.1.1 Number of air changes

- The ventilation system is to be capable of supplying at least 4 complete air changes per hour, based on the cofferdam gross volume.
- For cofferdams adjacent to spaces where dangerous mixtures may be present, such as cargo tanks of oil carriers, chemical carriers and gas carriers, the minimum number of air changes per hour is to be increased to 8.

##### 2.1.2 Type of ventilation

The ventilation is to be of the negative pressure type for cofferdams adjacent to dangerous spaces, as indicated in [2.1.1] b). Other cofferdams may have ventilation of the positive pressure type.

##### 2.1.3 Avoidance of stagnation zones

In order to avoid air stagnation zones, air exhaust ports inside the cofferdam are to be adequately distributed and the various landings are to consist of grates or perforated flats; inlet ducts are generally to end at the top of the cofferdam and outlet ducts are to extend below the floor plates, with suction ports at the level of the upper edge of ordinary floors or bottom longitudinals.

Particular attention is to be paid to the arrangement of inlet and outlet ducts in cofferdams surrounding cargo tanks of double hull tankers, where, due to the particular shape of the cofferdams and the presence of stiffening inside, the formation of stagnant zones is likely.

##### 2.1.4 Cofferdams that may be used as ballast tanks

Provision is to be made to blank the inlet and outlet ventilation ducts when cofferdams are used for the carriage of ballast.

#### 2.2 Other technical requirements

##### 2.2.1 Ventilation inlets and outlets

Ventilation inlets and outlets leading to the open air from cofferdams adjacent to dangerous spaces are to be fitted with wire net flame arresters and protective screens recognised as suitable by the Society. The spacing between them and from ignition sources, openings into spaces where ignition sources are present, openings into cargo tanks and air inlets and outlets of different spaces is to be not less than 3 m.

**Table 1 : Documents to be submitted**

No.	A/I (1)	Item
1	I	Schematic drawing of the installations
2	A	Calculation of number of air changes per hour for each cofferdam in cargo area
3	A	Line diagram of power supply circuits of control and monitoring systems, including circuit table
4	A	List and type of equipment and in particular type of fans and their arrangement in ducts
3	I	Plan of the location and arrangement of the control station, if any
3	A	List of remote control devices, if any
4	A	List of alarms
(1) A : to be submitted for approval; I : to be submitted for information.		

### 2.2.2 Fans

- a) Ventilation fans are to be of non-sparking construction of a type approved by the Society.
- b) Where ventilated cofferdams are adjacent to a dangerous space, the electric motors driving the ventilation fans are not to be located in the ventilation ducts.

### 2.2.3 Lighting

Where cofferdams are provided with electric lighting appliances, the ventilation system is to be interlocked with the lighting such that the ventilation needs to be in operation to energise the lighting.

### 2.2.4 Alarms

An audible and visual alarm is to be activated in the event of failure of the ventilation.

### 2.2.5 Additional requirements

For chemical tankers and gas carriers, the requirements in Pt D, Ch 8, Sec 12 and Pt D, Ch 9, Sec 12, respectively, are also to be applied.

## 3 Inspection and testing

### 3.1 Equipment and systems

**3.1.1** Equipment and systems are to be inspected and tested in accordance with the applicable requirements of the Rules relative to each piece of equipment of the system used for the ventilation of the cofferdams.

### 3.2 Testing on board

**3.2.1** Following installation on board, the ventilation systems are to be subjected to operational tests in the presence of the Surveyor.

## SECTION 9

# CENTRALISED CARGO AND BALLAST WATER HANDLING INSTALLATIONS (CARGOCONTROL)

### 1 General

#### 1.1 Application

**1.1.1** The additional class notation **CARGOCONTROL** is assigned, in accordance with Pt A, Ch 1, Sec 2, [6.14.9], to ships carrying liquid cargo in bulk fitted with a centralised system for handling liquid cargo and ballast and complying with the requirements of this Section.

**1.1.2** Compliance with these Rules does not exempt the Owner from the obligation of fulfilling any additional requirements issued by the Administration of the State whose flag the ship is entitled to fly.

#### 1.2 Documents to be submitted

**1.2.1** The documents listed in Tab 1 are to be submitted to the Society for approval.

The Society reserves the right to require additional plans or information in relation to the specific characteristics of the installations.

### 2 Design and construction requirements

#### 2.1 Control station

##### 2.1.1 Location of control station

a) The control station is to be located such as to allow visibility of the cargo tank deck area, and in particular of the cargo loading and unloading ramps.

b) The station is preferably to be situated in the accommodation area; should this be impracticable, the control station is to be bounded by A-60 class fire-resisting bulkheads and provided with two escapes.

##### 2.1.2 Communications

It is possible from the control station to convey orders to crew members on deck and to communicate with the navigating bridge, with cargo handling spaces, with the engine room and with the propulsion control room, where the latter is foreseen.

##### 2.1.3 Safety equipment

Where the control station is located in the cargo area, two complete sets of protective clothing in order to protect the skin from the heat radiating from a fire are always to be readily available together with three breathing apparatuses.

#### 2.2 Remote control, indication and alarm systems

##### 2.2.1 Remote control system

It is to be possible to carry out the following operations from the control station:

- opening and closing of valves normally required to be operated for loading, unloading and transfer of cargo and ballast (however, the opening and closing of valves is not required for the ends of cargo loading and unloading arrangements)
- starting and stopping of cargo pumps, stripping pumps and ballast pumps (alternative solutions may be considered in the case of pumps powered by turbines)
- regulation, if foreseen, of the number of revolutions of cargo pumps, stripping pumps and ballast pumps.

**Table 1 : Documents to be submitted**

No.	A/I (1)	Item
1	I	Schematic drawing of the installation
2	I	Plan of the location and arrangement of the control station
3	A	List of remote control devices
4	A	List of alarms
5	I	List of the equipment (sensors, transducers, etc.) and automation systems (alarm systems, etc.) envisaged with indication of the Manufacturer and of the type of equipment or system
6	A	Line diagram of power supply circuits of control and monitoring systems, including: <ul style="list-style-type: none"> <li>circuit table, in the case of electrical power supply</li> <li>specification of service pressures, diameter and thickness of piping, materials used, etc. in the case of hydraulic or pneumatic power supply</li> </ul>
(1) A : to be submitted for approval; I : to be submitted for information.		

### 2.2.2 Indication system

The control station is to be fitted with indicators showing:

- (open/closed) position of valves operated by remote control
- state (off/on) of cargo pumps, stripping pumps and ballast pumps
- number of revolutions of cargo pumps, stripping pumps and ballast pumps where they may be operated at adjustable speeds
- delivery pressure of the hydraulic plant for the operation of cargo pumps, stripping pumps and ballast pumps
- delivery and suction pressure of cargo pumps, stripping pumps and ballast pumps
- pressure of the ends of cargo loading and unloading arrangements
- oxygen level, temperature and pressure of the inert gas, where the operation of the inert gas system is required or envisaged at the same time as loading/unloading
- level in cargo and ballast tanks (relaxation of this requirement may be permitted for double bottom ballast tanks of reduced capacity and limited depth)
- temperature in cargo tanks provided with heating or refrigeration.

### 2.2.3 Alarm systems

The cargo control station is to be fitted with visual and audible alarms signalling the following:

- high level, and where requested very high level, in cargo tanks
- high pressure in cargo tanks, if required by the Rules

- low delivery pressure of the hydraulic plant for the operation of pumps and valves
- high vacuum in cargo tanks, if required by the Rules
- high pressure in the cargo and ballast lines
- high and low temperature for cargo tanks fitted with heating and refrigerating systems
- high oxygen level, high temperature, and high and low pressure of inert gas, if foreseen
- high level in a bilge well in cargo and ballast pump rooms
- high concentration of explosive vapours (exceeding 30% of the lower flammable limit) in spaces where cargo is handled
- high temperature of gas-tight seals with oil glands for runs of shafts, where these are foreseen through bulkheads or decks, for the operation of cargo and ballast pumps.

## 3 Inspection and testing

### 3.1 Equipment and systems

**3.1.1** Equipment and systems are to be inspected and tested in accordance with the applicable requirements of the Rules relative to each piece of equipment of the system used for the centralised control.

### 3.2 Testing on board

**3.2.1** Following installation on board, remote control, indication and alarm systems are to be subjected to operational tests in the presence of the Surveyor.

## SECTION 10

## SHIP MANOEUVRABILITY (MANOVR)

### 1 General

#### 1.1 Application

**1.1.1** The additional class notation **MANOVR** is assigned, in accordance with Pt A, Ch 1, Sec 2, [6.14.10], to ships whose manoeuvring capability standards comply with the requirements of this Section.

**1.1.2** The requirements of this Section reproduce the provisions of IMO Resolution A751(18) "Interim Standards for Ship Manoeuvrability".

Note 1: According to Resolution MSC.137(76), these provisions are to be applied to ships of all rudder and propulsion types, of 100 m in length and over, and to chemical tankers and gas carriers regardless of the length, which were constructed on or after January 2004.

#### 1.2 Manoeuvre evaluation

##### 1.2.1 Conventional trials

The requirements in this Section are based on the understanding that the manoeuvrability of ships can be evaluated from the characteristics of conventional trial manoeuvres.

##### 1.2.2 Compliance with the requirements

The following two methods can be used to demonstrate compliance with these requirements:

- Scale model tests and/or predictions using computer programs with mathematical models can be performed to predict compliance at the design stage.  
Results of the models test and/or computer simulations will be confirmed by full scale trials, as necessary.
- Compliance can be demonstrated based on the results of full scale trials conducted in accordance with these requirements.

### 2 Definitions

#### 2.1 Geometry of the ship

##### 2.1.1 Length (L)

Length (L) is the length measured between the aft and forward perpendiculars.

##### 2.1.2 Midship point

Midship point is the point on the centreline of a ship midway between the aft and forward perpendiculars.

##### 2.1.3 Draught $T_A$

The draught  $T_A$  is the draught at the aft perpendicular.

##### 2.1.4 Draught $T_F$

The draught  $T_F$  is the draught at the forward perpendicular.

##### 2.1.5 Mean draught $T_M$

The mean draught  $T_M$  is defined as  $T_M = (T_A + T_F)/2$ .

#### 2.2 Standard manoeuvres and associated terminology

##### 2.2.1 Test speed

The test speed (V) used in the requirements is a speed of at least 90% of the ship's speed corresponding to 85% of the maximum engine output.

##### 2.2.2 Turning circle manoeuvre

The turning circle manoeuvre is the manoeuvre to be performed to both starboard and port with 35° rudder angle or the maximum rudder angle permissible at the test speed, following a steady approach with zero yaw rate.

##### 2.2.3 Advance

Advance is the distance travelled in the direction of the original course by the midship point of a ship from the position at which the rudder order is given to the position at which the heading has changed 90° from the original course.

##### 2.2.4 Tactical diameter

Tactical diameter is the distance travelled by the midship point of a ship from the position at which the rudder order is given to the position at which the heading has changed 180° from the original course. It is measured in a direction perpendicular to the original heading of the ship.

##### 2.2.5 Zig-zag test

Zig-zag test is the manoeuvre where a known amount of helm is applied alternately to either side when a known heading deviation from the original heading is reached.

##### 2.2.6 10°/10° zig-zag test

10°/10° zig-zag test is performed by turning the rudder alternately by 10° either side following a heading deviation of 10° from the original heading in accordance with the following procedure.

- after a steady approach with zero yaw rate, the rudder is put over 10° to starboard/port (first run)
- when the heading has changed to 10° off the original heading, the rudder is reversed to 10° to port/starboard (second run)
- after the rudder has been turned to port/starboard, the ship will continue turning in the original direction with decreasing turning rate. In response to the rudder, the ship is then to turn to port/starboard. When the ship has reached a heading of 10° to port/starboard off the original course, the rudder is again reversed to 10° to starboard/port (third run).

### 2.2.7 First overshoot angle

The first overshoot angle is the additional heading deviation experienced in the zig-zag test following the second run.

### 2.2.8 Second overshoot angle

The second overshoot angle is the additional heading deviation experienced in the zig-zag test following the third run.

### 2.2.9 20°/20° zig-zag test

20°/20° zig-zag test is performed using the same procedure given in [2.2.6] above using 20° rudder angle and 20° change of heading, instead of 10° rudder angle and 10° change of heading, respectively.

### 2.2.10 Full astern stopping test

Full astern stopping test determines the track reach of ship from the time an order for full astern is given until the ship stops in water.

### 2.2.11 Track reach

Track reach is the distance along the path described by the midship point of a ship measured from the position at which an order for full astern is given to the position at which the ship stops in the water.

## 3 Requirements

### 3.1 Foreword

3.1.1 The standard manoeuvres are to be performed without the use of any manoeuvring aids which are not continuously and readily available in normal operations.

### 3.2 Conditions in which the requirements apply

3.2.1 In order to evaluate the performance of a ship, manoeuvring trials are to be conducted to both port and starboard and in the conditions specified below:

- deep, unrestricted water
- calm environment
- full load, even keel condition
- steady approach at test speed.

## 3.3 Criteria for manoeuvrability evaluation

### 3.3.1 Turning ability

The advance is not to exceed 4,5 ship lengths (L) and the tactical diameter is not to exceed 5 ship lengths in the turning circle manoeuvre.

### 3.3.2 Initial turning ability

With the application of 10° rudder angle to port/starboard, the ship is not to have travelled more than 2,5 ship lengths by the time the heading has changed by 10° from the original heading.

### 3.3.3 Yaw checking and course keeping ability

- a) The value of the first overshoot angle in the 10°/10° zig-zag test is not to exceed:
- 1) 10°, if L/V is less than 10 seconds,
  - 2) 20°, if L/V is 30 seconds or more, and
  - 3)  $(5 + 1/2 (L/V))$  degrees, if L/V is 10 seconds or more, but less than 30seconds, where L and V are expressed in m and m/second, respectively.
- b) The value of the second overshoot angle in the 10°/10° zig-zag test is not to exceed the above criterion values for the first overshoot by more than 15°.
- c) The value of the first overshoot angle in the 20°/20° zig-zag test is not to exceed 25°.

### 3.3.4 Stopping ability

The track reach in the full astern stopping test is not to exceed 15 ship lengths. However, this value may be increased at the discretion of the Society for large ships.

## 4 Additional considerations

### 4.1 Trials in different conditions

4.1.1 Where the standard trials are conducted in conditions different from those specified in [3.2.1]c, the corrections deemed necessary by the Society are to be made in each case.

### 4.2 Dynamic instability

4.2.1 Where standard manoeuvres indicate dynamic instability, the Society may require additional tests to be conducted to define the degree of instability, such as spiral tests or the pull out manoeuvre.

## SECTION 11

## COLD WEATHER CONDITIONS

### 1 General

#### 1.1 Application

**1.1.1** The additional class notations **COLD DI** and **COLD (H t<sub>DH</sub>, E t<sub>DE</sub>)** are assigned, in accordance with Pt A, Ch 1, Sec 2, [6.14.12], to ships intended for service in cold climate environments.

The additional class notation **COLD DI** is assigned to ships operating in cold climate environments for shorter periods, not necessarily including ice covered waters and fitted with systems and equipment for de-icing complying with the requirements of [2] to [4].

The additional class notation **COLD (H t<sub>DH</sub>, E t<sub>DE</sub>)** is assigned to ships operating in cold weather conditions, as defined in [1.1.2], built and fitted with systems and equipment for de-icing complying with the requirements of [2] to [6], where t<sub>DH</sub> and t<sub>DE</sub> are defined in [1.1.2] for, respectively, hull and equipment exposed to low air temperature.

The additional class notation **COLD CARGO** is assigned in accordance with Pt A, Ch 1, Sec 2, [6.14.13], complying with the additional requirements given in [8].

#### 1.1.2 Cold weather conditions

The requirements of this Section apply to ships intended to operate with the following conditions:

- t<sub>DH</sub> : Lowest mean daily average air temperature in the area of operation, in °C, to be considered for the hull exposed to low air temperature, provided by the ship designer
- t<sub>DE</sub> : Lowest design external air temperature in the area of operation, in °C, to be considered for the equipment exposed to low air temperature, provided by the ship designer. This temperature can be set to 20°C below the lowest mean daily average air temperature if information for the relevant trade area is not available
- Sea water temperature: not below –2°C
- Wind speed: not higher than 30 knots.

**1.1.3** The requirements for the additional class notation **COLD DI** concern mainly the following functions of the ship and its equipment under cold weather conditions:

- decks and superstructures
- propulsion
- machinery installations
- electricity installations
- navigation
- crew protection
- elimination of ice where necessary for safe access.

The requirements for the additional class notation **COLD (H t<sub>DH</sub>, E t<sub>DE</sub>)** cover also:

- hull
- stability
- material.

#### 1.2 Documentation to be submitted

##### 1.2.1 Plans and documents to be submitted for approval

When the additional class notation **COLD DI** is assigned, the plans and documents listed in Tab 1 are to be submitted to the Society for approval.

When the additional class notation **COLD (H t<sub>DH</sub>, E t<sub>DE</sub>)** is assigned, the plans and documents listed in Tab 2 are to be submitted, in addition to those listed in Tab 1, to the Society for approval.

**Table 1 : Documents to be submitted for approval COLD DI and COLD (H t<sub>DH</sub>, E t<sub>DE</sub>)**

Plan or document
De-icing systems including heating systems: <ul style="list-style-type: none"> <li>• diagrams of the steam, hot water, thermal oil piping or other systems used for de-icing purposes</li> <li>• arrangement of the heat tracing systems</li> <li>• de-icing arrangements of ballast tanks, sea chests, overboard discharges</li> <li>• de-icing arrangements for air intakes</li> </ul>
De-icing devices distribution board
Wheelhouse and cargo control room de-icing system arrangement

**Table 2 : Documents to be submitted for approval COLD (H t<sub>DH</sub>, E t<sub>DE</sub>) only**

Plan or document
Distribution of steel qualities in structures exposed to low air temperatures
Trim and stability booklet including the additional loading conditions with ice accretion
Damage stability calculations when applicable for the loading conditions with ice accretion
Compartments containing internal combustion engines, auxiliary systems, HVAC systems: <ul style="list-style-type: none"> <li>• heat balance for ventilation / air supply to engine turbo-blowers</li> <li>• heat balance for sea water / fresh water cooling circuits</li> <li>• minimum temperatures required for ambient air to ensure satisfactory operation of the concerned equipment</li> </ul>
Deck machinery arrangement (windlasses, winches and deck cranes) including their remote control system

### 1.2.2 Plans and documents to be submitted for information

When the additional class notation **COLD DI** is assigned, the plans and documents listed in Tab 3 are to be submitted to the Society for information.

When the additional class notation **COLD (H t<sub>DH</sub>, E t<sub>DE</sub>)** is assigned, the plans and documents listed in Tab 4 are to be submitted, in addition to those listed in Tab 3, to the Society for information.

**Table 3 : Documents to be submitted for information COLD DI and COLD (H t<sub>DH</sub>, E t<sub>DE</sub>)**

Plan or document
De-icing arrangements for gangways, access, working areas, etc.
List of tools for ice removal
Electrical load balance, including "de-icing case"
De-icing system layout (electrical heat tracing)
Procedure for de-icing the sea chests

**Table 4 : Documents to be submitted for information COLD (H t<sub>DH</sub>, E t<sub>DE</sub>) only**

Plan or document
Plan showing the detail of the location of the ice accretion, the detail of the area calculation and the total weight of ice for each area

### 1.2.3 Plans and documents to be kept on board

The Owner is to keep on board the ship the following plans and documents and they are to be made available to the Surveyor:

- when the additional class notation **COLD DI** is assigned:
  - manual for de-icing procedures
- when the additional class notation **COLD (H t<sub>DH</sub>, E t<sub>DE</sub>)** is assigned:
  - manual for de-icing procedures
  - stability manual including loading conditions with ice accretion.

## 1.3 Testing

**1.3.1** Following installation on board, the systems are to be subjected to operational tests to the satisfaction of the Surveyor.

## 2 Machinery installations

### 2.1 General

#### 2.1.1 Application

The requirements contained in the present Article cover:

- the ship propulsion system and other essential systems
- the prevention of ice formation which could be detrimental to the safety of the ship or of the passengers and crew.

**2.1.2** Thermal barriers are to be considered for all pipe or duct penetrations from exposed decks or bulkheads.

## 2.2 Principles

### 2.2.1 Operation of the propulsion system and other essential systems

- a) As a general rule, the temperature inside the machinery compartments is to be kept above a minimum value allowing the equipment located in those compartments to operate without restrictions. This applies in particular to the propulsion plant, the electricity generation plant, the emergency generating set, the emergency fire pump and auxiliary systems (such as fuel oil transfer, supply and return piping systems, lubricating oil systems, cooling systems, sewage systems, etc.) and to other essential systems as defined in Pt C, Ch 2, Sec 1.
- b) The ventilation capacity can be adjusted so as to limit the heat losses. It should however satisfy the engine needs of combustion air while avoiding excessive vacuum in the compartment.

Note 1: The attention is drawn to any requirements which may impose a minimum number of air changes in the compartment, in particular to avoid flammable oil or gas accumulation.

- c) Working liquids (such as fuel oil, lubricating oil, hydraulic oil) are to be maintained in a viscosity range that ensures proper operation of the machinery.

### 2.2.2 Prevention of ice build-up inside pipes and associated fittings

- a) Arrangements are to be made to avoid the build-up of ice inside air pipes (in particular those connected to sea chests, cooling water recirculation tanks and ballast tanks) and inside their automatic closing devices, where fitted.
- b) It also applies to:
  - sounding pipes and overflow pipes serving cooling water recirculation tanks and water ballast tanks
  - piping systems located in exposed areas, including ro-ro spaces, such as compressed air lines, steam lines or steam drain lines when not in use
  - spray water lines
  - exposed deck scuppers, washing lines and discharge lines.
- c) The fire main is to be arranged so that exposed sections can be isolated and means of draining of exposed sections are to be provided. Fire hoses and nozzles need not be connected to the fire main at all times, and may be stored in protected locations near the hydrants.

Note 1: The above mentioned systems are to be drained when not in use.

### 2.2.3 Prevention of ice build-up in air intakes

Arrangements are to be made to avoid ice accretion on the fresh air intake components (ventilators, louvers, casings, scuppers, etc.), in particular on those serving the machinery spaces, emergency generating set room and HVAC rooms. This may be accomplished by means of closed-circuit ventilation sequences or by electric or steam tracing of the said components.



## 2.3 Design requirements

### 2.3.1 Arrangement of pipes subject to ice build-up

- The pipes subject to ice build-up (see [2.2.2]) are to be placed in unexposed locations, or protected by screening, heat tracing or other suitable arrangement.
- Where provided, the insulation material is to be protected by a suitable sheath so designed as to withstand possible sea impacts.
- Exposed scuppers and discharge pipes are to be arranged with heat tracing.

### 2.3.2 Instrumentation

- Provisions are to be made to ensure a satisfactory operation of the level sensors and remote gauging indicators in ballast tanks.
- Temperature sensors are to be provided in each ballast tank, giving an alarm in case of low temperature in the tank.

Note 1: The temperature alarms are to be inhibited when the ballast capacities are not used.

- Temperature and pressure sensors are to be fitted in sea bay, so as to generate an alarm.
- Ballast pumps are to be fitted with alarm and shutdown, in case of low pressure at the pump suction.

### 2.3.3 P/V valves

Specific heating is to be provided for the cargo P/V valves, if any, so as to maintain their proper operation.

## 3 Electrical installations

### 3.1 General

**3.1.1** The permanent electrical de-icing devices are to comply with the rules indicated in Part C, Chapter 2.

**3.1.2** Thermal barriers are to be considered for all cables or cable duct penetrations from exposed decks or bulkheads.

### 3.2 System design

#### 3.2.1 Electrical power for de-icing devices

The electrical power necessary to supply the de-icing devices is to be considered as a permanent load. A specific case of load balance taking into account the load of these de-icing devices is to be submitted to the Society.

#### 3.2.2 Services to be considered for de-icing arrangement

The following services are to be considered for de-icing arrangement:

- heated bridge windows and heated cargo control room windows, including arrangement for heating/isolating the windows washing water system, which avoid formation of ice, or mist reducing the visibility through the windows
- installation of electrical de-icing system for all escape doors and all main doors giving access to the deck area. The system is to be arranged so as to avoid formation of ice, which may block the door

- heating of bunker lines on deck, when electrical heat tracing is provided together with insulation
- heating of scupper lines when electrical heat tracing is provided
- sequence of ventilation in loop in the air inlet compartment so as to avoid ice formation on air intakes for HVAC, machinery room, and emergency generator room
- heating of whistle
- heating of antennas and similar equipment
- a socket outlet is to be provided close to each lifeboat so as to supply the heating system of lifeboat engine.

**3.2.3** The electrical services as indicated in [3.2.2] are considered as essential services. They may be activated manually, when the outside temperature alarm is activated.

**3.2.4** The heating power capacity for sizing the de-icing system is to be based on a minimum of  $10 |t_{DE}|$  W/m<sup>2</sup>, or 300 W/m<sup>2</sup>, whichever is the larger.

**3.2.5** When the outside temperature is below  $-10^{\circ}\text{C}$  during more than 5 hours, an alarm is to be triggered, so as to inform the personnel that the de-icing system is to be put into service.

## 3.3 Protection

**3.3.1** The heating cables or electrical heating system are to be protected against overload and short circuit.

**3.3.2** When heating cables are of the self regulated type, the overload protection may be omitted.

**3.3.3** The distribution boards dedicated to the de-icing devices are to be arranged with indication of the devices in service.

**3.3.4** The distribution boards dedicated to the de-icing devices are to be arranged with insulation monitoring. A specific alarm dedicated to this service is to be provided.

**3.3.5** Where electrical heat tracing is provided in dangerous area, the temperature surface of the cable is not to exceed the maximum temperature allowed for the type of cargo, the ship is entitled to carry.

## 4 Additional requirements

### 4.1 De-icing of deck areas

**4.1.1** A steam, high pressure hot water, or electrical heating system is to be provided on the exposed deck to allow the de-icing of the ship areas to which the crew may have access during the normal operation of the ship, in particular:

- manoeuvring area
- loading / unloading area
- area around the access to the deckhouses
- passageways, gangways, walkways.

**4.1.2** The circulation on exposed decks is to be facilitated by the use of appropriate gratings and stairs (including escapes, access to lifeboats, to winching areas). Where necessary, safety lines are to be provided on the exposed deck.

**4.1.3** Manual de-icing may be accepted as an alternative method to a limited extent, where such a method is found appropriate and practical.

## 4.2 De-icing tools

**4.2.1** De-icing tools, such as scrapers, lances, showels, etc., are to be provided on board to allow manual de-icing.

They are to be kept in stores of the main deck and at locations protected from ice accretion.

The quantity of equipment is to be sufficient for manual de-icing operation.

## 4.3 Protection of deck machinery

**4.3.1** Specific arrangement for protection of deck machinery (foam monitors, davits, lifeboats, lifejackets lockers, winches, windlasses, cranes), helideck and its access, suppressing the risk of ice formation, such as machinery located in protected spaces, or specific protection arrangement preventing sea water spraying is to be provided.

## 4.4 Closing appliances and doors

**4.4.1** Means are to be provided to remove or prevent ice and snow accretion around hatches and doors (in way of the contact area).

**4.4.2** When hatches or doors are hydraulically operated, means are to be provided to prevent freezing or excessive viscosity of liquids.

**4.4.3** Watertight and weathertight doors, hatches and closing devices which are not within an habitable environment and require access while at sea are to be designed to be operated by personnel wearing heavy winter clothing including thick mittens.

## 4.5 HVAC

**4.5.1** The HVAC plant is to be designed so as to ensure adequate temperature in the accommodation with outside air temperature. Arrangement is made to control humidity.

## 4.6 Other protections

**4.6.1** Specific protection, such as tarpaulins is to be fitted for cargo valves and associated instrumentation.

**4.6.2** Firefighter's outfits are to be stored in warm locations on the ship.

# 5 Specific requirements for COLD (H $t_{DH}$ , E $t_{DE}$ )

## 5.1 Hull

### 5.1.1 Grades of steel

The grades of steel for structures exposed to low air temperatures are given in Pt B, Ch 4, Sec 1.

**5.1.2** Any fitting or construction lugs in the bow area are to be removed. The bow area is to be of good well fared construction to reduce the possibility of spray production.

The selection and method of fitting of bow anchors with regard to potential spray formation is to be carefully considered. Recessed anchors or anchors in pockets are to be considered.

**5.1.3** Shell plating and bow area are to be as smooth as possible to prevent the formation of spray.

**5.1.4** Bow anchors are to be recessed as far as possible or in pockets, with provision to ensure that they cannot freeze in place.

**5.1.5** Anchors and chain cables are to be of low temperature steel suitable for the conditions defined in [1.1.2].

**5.1.6** Material used in external structures above the waterline is to be appropriate for the temperature  $t_{DH}$  given in the class notation.

External structure is defined as the plating with stiffening to a distance of 0,6 meter inwards from the shell plating, exposed decks and sides of superstructure and deckhouses.

In general deckhouses and superstructures are of material class I. Deckhouses or superstructures exposed to longitudinal stresses within 0,6 L amidships are of material class II.

## 5.2 Stability

### 5.2.1 General

The requirements of Pt B, Ch 3, Sec 2, [2] and Pt B, Ch 3, Sec 2, [3] and the applicable requirements of Part F for ships with the additional class notation **SDS** are to be complied with for the loading conditions described in Pt B, Ch 3, App 2, taking into account the additional weight of ice indicated in [5.2.2].

### 5.2.2 Weight of ice accretion

The weight distribution of the ice accretion is to be considered on the full length of the ship from the exposed deck and the decks above, including the sides, as follows:

- 30 kg/m<sup>2</sup> for the horizontal exposed areas
- 7,5 kg/m<sup>2</sup> for the vertical or oblique exposed areas.

For the purpose of the calculation the masts are excluded.

## 6 Additional requirements for machinery installations for COLD (H $t_{DH}$ , E $t_{DE}$ )

### 6.1 General

#### 6.1.1 Application

The requirements contained in the present Article cover the ship propulsion system and other essential systems, which are to remain in operation at the temperature  $t_{DE}$ .

#### 6.1.2 Materials

The materials of pipes and other equipment located on open deck and not insulated are to be suitable for the temperature  $t_{DE}$ . The materials of pipes are to comply with recognized standards such as EN10216-4, EN10217-6, etc.

The use of cast iron and other brittle materials are not permitted in areas exposed to low temperature.

Gaskets, jointing materials and seals are to be suitable for the temperature  $t_{DE}$ .

### 6.2 Principles

#### 6.2.1 Operation of the propulsion system and other essential systems

- Arrangements are to be made to ensure that the machinery can be brought into operation from the dead ship condition assuming an air temperature of  $t_{DE}$ .
- A partial reduction in propulsion capability may be accepted in cold weather conditions provided that the safety of the ship is not impaired.

Note 1: The reduced power is not to be lower than the minimum power required by the ice class notation, where applicable.

#### 6.2.2 Sea inlet and overboard discharge de-icing

Arrangements are to be made to avoid any blockage by ice of:

- the sea inlets
- the overboard discharges situated above the water line as well as up to 1 m below the ballast water line.

#### 6.2.3 Ballast tank de-icing

- Arrangements are to be provided to prevent water ballast freezing in tanks adjacent to the shell and located totally or partly above the ballast water line.
- The following systems will be accepted to prevent water ballast freezing:
  - heating systems
  - internal circulating / pumping systems
  - bubbling systems
  - steam injection systems.
- This also applies to other tanks subject to freezing (such as fresh water, fuel oil).

#### 6.2.4 Fire main and air vents heads

At least one of the fire pumps is to be connected to the sea inlet referred to in [6.3.1].

When fixed water-based firefighting systems are located in a space separate from the main fire pumps and use their own independent sea suction, this sea suction is to be also capable of being cleared of ice accumulation (design requirement as specified in [6.3.1], item c)).

Refer also to Pt C, Ch 4, Sec 6, [1.2.1].

Air vents heads are to be fitted with de-icing device.

### 6.3 Design requirements

#### 6.3.1 Design of the sea inlets

- The ship is to be provided with at least one sea bay from which pumps supplying cooling water to essential machinery draw.
- The sea bay is to:
  - be supplied with water from at least two sea chests, and
  - be connected to the sea chests by pipes, valves and strainers with a cross sectional area equal to the total area of the suctions served by the sea bay.
- The sea chests are to:
  - be fitted on each side of the ship
  - be as deeply submerged as possible
  - have an open area to the sea of at least five times the total area of the pump suctions served by the sea bay
  - be fitted with a strainer plate at the ship's side having perforations approximately 20 mm diameter to prevent ingestion of large ice particles
  - be fitted with a steam or compressed air connection for clearing the strainer complying with Pt C, Ch 1, Sec 10, [2.8.4], item e).
- Diversion valves and piping are to be provided at overboard cooling water discharges to permit warm water to be returned to the sea chests to prevent blockage.
- Suction pipes are to be connected as low as possible to the sea chest.

Note 1: Other arrangements affording equivalent availability of the cooling water supply can also be considered. Engine cooling systems served by water ballasts may be accepted subject to special consideration.

#### 6.3.2 Design of heating systems intended for ballast tanks

- Onboard ships where flammable cargo vapours may enter the ballast tanks in case of structural damage, the temperature of any part of the heating system is not to exceed the maximum temperature allowed for the cargo.
- The heating lines including the return lines are to be independent from those serving the cargo tanks.
- Heating coils which are not in use are to be drained.

#### 6.3.3 Bubbling systems

- Bubbling systems are to be so designed as to avoid any ice formation in the tank which may be detrimental to the tank structure.
- The bubbling system is to include a sufficient number of air nozzles distributed throughout the tank bottom.

- c) The maximum pressure induced in the tank by the air supply system is not to exceed the design pressure of the tank.
- d) The bubbling system may be served:
- either by a dedicated compressed air plant, or
  - by the general service air system provided its capacity takes into account the air consumption of the bubbling system.

### 6.3.4 Prevention of tank over-pressurisation

Provisions are to be made to prevent over-pressurizing the tanks and sea chests when the air or steam injection system is operating. Pressure reduction devices are to be fitted where deemed necessary.

### 6.3.5 Supporting of pipes

The design and arrangement of the pipe supports and collars are to take into account the weight of ice accretion, which is calculated in accordance with the provisions of [5.2.2].

## 7 Other additional requirements for COLD (H $t_{DH}$ , E $t_{DE}$ )

### 7.1 General

7.1.1 Electrical equipment fitted in open decks are to be suitable for operation at the temperature  $t_{DE}$ .

### 7.2 Cableways supports

7.2.1 Cableways supports are to be designed so as to take into consideration the ice load.

### 7.3 Navigation and communication equipment

7.3.1 Attention is to be paid ensuring that navigation and communication equipment is suitable for the temperature  $t_{DE}$ .

### 7.4 Fire safety systems

7.4.1 Portable and semi-portable extinguishers are to be located in positions protected from freezing temperatures, as far as practical. Locations subject to freezing are to be provided with extinguishers capable of operation under the temperature  $t_{DE}$ .

### 7.5 Others protections

7.5.1 Personal protection and evacuation equipment are to be suitable for the temperature  $t_{DE}$ .

### 7.5.2 Personal protection for chemical tankers and gas carriers

The protective, safety and emergency equipment for personnel protection (as required by IBC Code, as amended, Chapter 14 or IGC Code, as amended, Chapter 14) is to be suitable for the temperature  $t_{DE}$ . The possibility for repeated operation of decontamination showers and an eyewash on deck at the temperature  $t_{DE}$  is to be carefully considered.

## 8 Additional requirements for COLD CARGO

### 8.1 General

#### 8.1.1 Application

The requirements of this Article apply to ships having one of the service notation **oil tanker**, **product tanker** or **chemical tanker** intended to be loaded with liquid cargoes:

- having a cargo temperature below  $-10^{\circ}\text{C}$ , in particular when loading is from cold storage tanks (winter conditions), and
- that do not need to be heated in normal operating conditions.

#### 8.1.2 Documents and information to be submitted

The following documents and information are to be submitted:

- general layout drawing of the cargo and ballast tanks
- diagram of the ballast piping system, cargo system, steam / thermal oil heating system and steam condensate system with instrumentation
- details of the heating arrangements (capacity, drawings of the heat exchangers)
- characteristics of the cargo (thermal conductivity, heat value, density, boiling point, flash point, viscosity vs. temperature)
- heat transfer calculation note (see [8.3.3])
- cargo loading and heating procedures
- risk analysis (see [8.4]).

### 8.2 Arrangements

#### 8.2.1 Principles

Arrangements are to be made to:

- avoid excessive ice built-up in the ballast tanks located adjacent to the cargo tanks, which may be detrimental to the ship structure
- avoid freezing of the heating fluid in the cargo heaters and in the piping system supplying the heating medium
- maintain the temperature of the heated cargo in all heaters below its boiling point
- maintain the temperature of the cargo in the tanks below its flash point.

### 8.3 Design and arrangement of the cargo heating means

#### 8.3.1 General

Arrangements are to be made to heat the cargo during loading and after loading, except that:

- products with a flash point below  $60^{\circ}\text{C}$  are not to be directly heated
- products are not to be directly heated by steam or thermal oil having a temperature exceeding the boiling point of the products.

### 8.3.2 Heating of the cargo tank trunks

Arrangements are to be made to maintain positive temperature in all cargo tank trunks. A sufficient steam capacity is to be made available for that purpose.

The heaters located in the tank trunks are to comply with the following provisions:

- The heaters are to be kept in permanent operation or drained and isolated after each use so that they may not be rendered inoperative due to ice build-up or thermal oil gelation
- The steam / thermal oil pipes supplying the heaters are to be provided with efficient thermal insulation so as to provide the highest heat level at the heater inlet. The condensate lines are to be provided with heat tracing and suitably insulated
- The valves serving the heaters are to be arranged with heating and thermal insulation allowing their operation in the worst expected conditions
- Means are to be provided to monitor the proper operation of the heaters.

### 8.3.3 Heating of a cargo tank by the adjacent ballast tanks

Where direct heating of the product is not permitted (see [8.3.1]), the adjacent ballast tanks may be accepted as a heating source for the cargo tanks provided that:

- the ice accretion on the ballast tank walls does not exceed 10% of the tank width (lateral tanks) or height (bottom tanks), which is to be justified by heat transfer calculations
- ballast tanks are provided with de-icing arrangements complying with the provisions of [6.2.3]
- as far as practicable with respect to the ship safety (stability and structural integrity), the level in the ballast tanks is kept as close as possible to the ship water line.

### 8.3.4 Circulation of the products in cargo tanks

Arrangements are to be made to circulate the liquid cargo in the tanks during cargo heating-up.

### 8.3.5 Thermometers and temperature sensors

Temperature sensors and thermometers intended for the cargo are to be suitable for temperatures down to  $-25^{\circ}\text{C}$ .

## 8.4 Risk analysis

**8.4.1** The risk analysis is to cover at least the following failures:

- overheating of the cargo due to insufficient circulation, cargo pump failure, etc., which could lead to the creation of an explosive atmosphere
- freezing of the heating medium due to the low temperature of the cargo
- excessive ice built-up in the ballast tanks.

## 8.5 Materials

### 8.5.1 Plating exposed to cold cargo

The selection of the steel grade for the plating of cargo tank boundary exposed to cold cargo is to be based on the following:

- the design minimum cargo temperature ( $t_c$ )
- the steel grade corresponding to the requirements for material class I at low temperatures as defined in Pt B, Ch 4, Sec 1, Tab 11.

The design minimum cargo temperature ( $t_c$ ) is to be specified in the loading manual.

### 8.5.2 Other structural elements

The steel grades of other structural elements are considered by the Society on a case-by-case basis.

# SECTION 12

## EFFICIENT WASHING OF CARGO TANKS (EWCT)

### 1 General

#### 1.1 Application

**1.1.1** The additional class notation **EWCT** is assigned, in accordance with Pt A, Ch 1, Sec 2, [6.14.15], to ships granted with the service notation **Oil Tanker, FLS Tanker** or **Chemical Tanker** fitted with efficient washing arrangements complying with this Section.

#### 1.2 Documents to be submitted

**1.2.1** The documents listed below are to be submitted.

- cargo tank arrangement
- coatings
- shadow diagrams
- cargo piping system diagram
- cargo tank cleaning system diagram
- tank washing machine specifications
- operation manual.

The Society reserves the right to require additional plans or information in relation to the specific characteristics of the installation.

### 2 Design requirements

#### 2.1 Cargo tanks

**2.1.1** Tanks are to be designed with smooth bulkheads to reduce any possibility of accumulation of residues. In principle, stiffeners and brackets that could accumulate residues and prevent efficient cleaning are not acceptable.

**2.1.2** Bulkheads may be corrugated but special care is to be taken over the design of the corrugations especially those which are horizontal. The angle of the corrugations is

to be such as to ensure that the washing jet from the fixed washing machines have the necessary cleaning impact on the surface. The location of the washing machines and the shadow areas are to be taken into account.

**2.1.3** Cargo tanks are to be either effectively coated or of stainless steel construction.

**2.1.4** Heating coils are to be of corrosion resistant materials, stainless steel or equivalent.

#### 2.2 Cargo piping system

**2.2.1** Cargo piping are to be either effectively coated internally or of stainless steel construction.

**2.2.2** Cargo pumps are to be of the deep-well type individual to each tank with one or more units per tank and located with the necessary suction wells for adequate drainage.

#### 2.3 Cargo tank cleaning system

**2.3.1** The tank cleaning heater is to be capable of maintaining a minimum temperature of 85°C with adequate throughput to clean the largest tank.

**2.3.2** Tank washing machines are to be permanently installed and give no less than 96% coverage of each tank based upon 70% of the washing jet length at its normal operating pressure. Tank fittings such as ladders heating coils need not be included as shadow areas.

**2.3.3** Portable tank washing machines and the necessary openings and equipment are to be provided along with the necessary guidance how to tackle any shadow areas. The use of the portable tank cleaning machines should not require tank entry by personnel.

## SECTION 13

# PROTECTED FO TANKS (PROTECTED FO TANKS)

### 1 General

#### 1.1 Application

**1.1.1** The provisions of the present Section apply only to ships with an aggregate oil fuel capacity of less than 600 m<sup>3</sup>.

Note 1: For ships with an aggregate oil fuel capacity of 600 m<sup>3</sup> and above, the provisions of Pt C, Ch 1, Sec 10, [11.5.3] apply.

**1.1.2** The provisions of this Section apply to all oil fuel tanks except small oil fuel tanks, as defined in [1.2.5].

#### 1.2 Definitions

**1.2.1** "Oil fuel" means any oil used as fuel oil in connection with the propulsion and auxiliary machinery of the ship in which such oil is carried.

**1.2.2** "Length (L)" means 96% of the total length on a waterline at 85% of the least moulded depth measured from the top of the keel, or the length from the foreside of the stem to the axis of the rudder stock on that waterline, if that be greater. In ships designed with a rake of keel the waterline on which this length is measured shall be parallel to the designed waterline. The length (L) shall be measured in metres.

**1.2.3** "Breadth (B)" means the maximum breadth of the ship, in metres, measured amidships to the moulded line of the frame in a ship with a metal shell and to the outer surface of the hull in a ship with a shell of any other material.

**1.2.4** "Oil fuel tank" means a tank in which oil fuel is carried, but excludes those tanks which would not contain oil fuel in normal operation, such as overflow tanks.

**1.2.5** "Small oil fuel tank" is an oil fuel tank with a maximum individual capacity not greater than 30 m<sup>3</sup>.

**1.2.6** "C" is the ship's total volume of oil fuel, including that of the small oil fuel tanks, in m<sup>3</sup>, at 98% tank filling.

**1.2.7** "Oil fuel capacity" means the volume of a tank in m<sup>3</sup>, at 98% filling.

### 2 Design requirements

#### 2.1 Distance from the bottom shell plating

**2.1.1** Oil fuel tanks are to be located above the moulded line of the bottom shell plating nowhere less than the distance  $h$  as specified below:

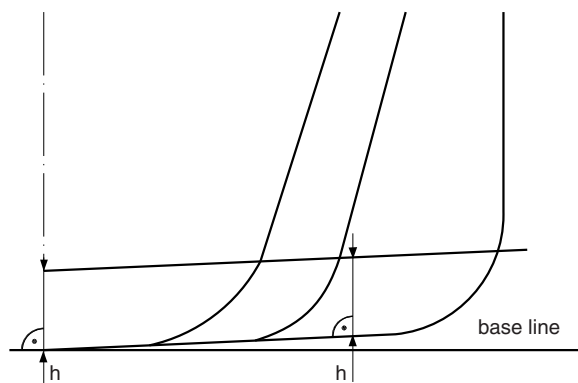
$h = B / 20$  m or

$h = 2,0$  m, whichever is the lesser.

The minimum value of  $h$  is 0,76 m.

**2.1.2** In the turn of the bilge area and at locations without a clearly defined turn of the bilge, the oil fuel tank boundary line shall run parallel to the line of the midship flat bottom as shown in Fig 1.

**Figure 1 : Oil fuel boundary lines relating to bottom shell**



#### 2.2 Distance from the side shell plating

**2.2.1** Oil fuel tanks shall be located inboard of the moulded line of the side shell plating, nowhere less than the distance  $w$  which, as shown in Fig 2, is measured at any cross-section at right angles to the side shell, as specified below:

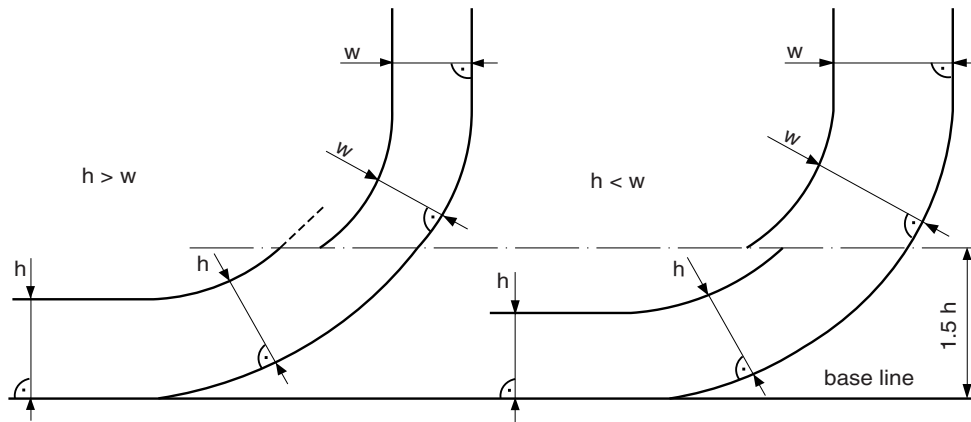
$w = 0,4 + 2,4 C / 20000$  m

The minimum value of  $w$  is 0,76 m.

#### 2.3 Oil fuel piping lines

**2.3.1** Lines of oil fuel piping located at a distance from the ship's bottom of less than  $h$ , as defined in [2.1], or from the ship's side less than  $w$ , as defined in paragraph [2.2] are to be fitted with valves or similar closing devices within or immediately adjacent to the oil fuel tank. These valves are to be capable of being brought into operation from a readily accessible enclosed space the location of which is accessible from the navigation bridge or propulsion machinery control position without traversing exposed freeboard or superstructure decks. The valves are to close in case of remote control system failure (fail in a closed position) and are to be kept closed at sea at any time when the tank contains oil fuel except that they may be opened during oil fuel transfer operations.

Figure 2 : Oil fuel boundary lines relating to side shell



**2.3.2** The valves or similar closing devices referred to in [2.3.1] above may be located in the double bottom provided they are arranged at a distance from the ship's bottom of not less than 0,5 h.

**2.3.3** Air pipes and overflow pipes from oil fuel tanks are not considered as part of the lines of fuel oil piping referred to in [2.3.1] above and may therefore be located at a distance from the ship side of less than w.

## 2.4 Suction wells

**2.4.1** Suctions wells in oil fuel tanks may protrude into the double bottom below the boundary line defined by the distance h provided that such wells are as small as practicable and the distance between the well bottom and the bottom shell plating is not less than 0,5 h.



## SECTION 14

# INCREASED ADMISSIBLE CARGO TANK PRESSURE (IATP)

## 1 Application

### 1.1 Ships covered by this section

**1.1.1** This Section applies to ships having the service notation **liquefied gas carrier** or **LNG bunkering ship** and intended to carry methane (LNG) whose maximum cargo tank design pressure does not exceed 70 kPa and that are designed and built so as to allow the pressure in the tanks to increase above 25 kPa.

LNG carriers with **IATP** notation are characterized by:

- a dual setting of the cargo tanks pressure relief valves, or

Note 1: The operational conditions and limitations for both setting pressure are to be specified in a memoranda.

- a boil-off handling system whose available capacity can be lower than 100% of the nominal boil-off rate of the ship during the periods referred to in [4.3.2], or
- both.

### 1.2 Scope

**1.2.1** This section covers:

- the ship's structure
- the cargo tanks pressure relieving system
- the boil-off gas management system.

## 2 Documentation to be submitted

### 2.1 Drawings and documents to be submitted to the Society

**2.1.1** The following drawings and documents are to be submitted to the Society for review:

- Cargo tanks venting system specification, where the different values of the pressure relief valves setting and the related high pressure alarm levels are indicated.
- Pressure relief valves drawings for cargo tanks.
- Calculation of the maximum filling level for each cargo tank depending on the setting of the pressure relief valves.
- Justification of the reduction of the available gas handling system capacity referred to in [4.3.3].

**2.1.2** The following documents are to be submitted to the Society for information:

- Cargo functional diagrams when all the tanks are not operated at the same pressure.
- Cargo operation manual and procedures, including:
  - procedure associated with changing the set pressure of the cargo tanks relief valves
  - cargo handling procedures when all the tanks are not operated at the same pressure.
- Ship to ship transfer procedure if relevant.

## 3 Definitions

### 3.1

#### 3.1.1 Nominal boil-off gas rate (NOBG)

For the purpose of this Section, the nominal boil-off gas rate means the maximum boil-off rate considering an ambient temperature of 45°C, as specified by the cargo containment system designer.

#### 3.1.2 Boil-off gas handling system

For the purpose of this Section, the gas handling system means all the equipment installed on board the gas carrier and allowing the boil-off gas disposal. Boil-off gas handling system includes gas or dual fuel engines, gas turbines, boilers, Gas Combustion Units (GCU) and reliquefaction installations, or other gas consuming equipment, as appropriate.

## 4 General design requirements

### 4.1 Ship design

#### 4.1.1 Ship's structure

The ship's structure is to be designed and tested according to Part D, Chapter 9, taking into consideration the maximum service pressure in the cargo tanks.

When cargo tank pressure relief valves with dual setting pressure are installed, in accordance with [4.2.3], the ship's structure is to be designed and tested for both setting pressure depending on the operational condition.

The case where the pressure in one or several cargo tanks is the atmospheric pressure while the pressure in the other cargo tanks is at the highest allowable service pressure is to be considered, if necessary.

## 4.2 Cargo tanks pressure relieving system

### 4.2.1 General arrangement of the cargo tank pressure relieving system

The following requirements apply to ships whose cargo tanks are provided with pressure relief valves with single or dual setting values.

Installations with more than 2 pressure relief valves settings will be subject to special examination by the Society.

### 4.2.2 Installation with single setting of the pressure relief valves

When single setting cargo tanks pressure relief valves are installed, the pressure relieving system is to be designed according to the appropriate requirements of IGC Code and Part D, Chapter 9.

### 4.2.3 Installation with dual setting of the pressure relief valves

Cargo tanks pressure relief valves with dual setting pressure are to be in accordance with IGC code 8.2.7.

If three way valves are used for the selection of the pressure setting, positive locking devices are to be provided.

If an auxiliary pilot unit is installed on the permanently installed pilot, its setting is not to be modified when it is handled and it must be sealed as required in IGC Code.

When not in use, the auxiliary pilots are to be safely stored so as to minimize the risks of mechanical damage and/or modification of setting.

### 4.2.4 Visual indication of the safety valve setting

When dual setting pressure relief valves are installed, arrangements are to be made in order to allow a visual verification of the setting of the pressure relief valves.

### 4.2.5 Modification of the pressure relief valves setting at sea

When dual setting pressure relief valves are installed, the changing of the setting is not to be done automatically and is to require a manual operation.

The changing of the set pressure during laden voyage is to be carried out under the supervision of the master in accordance with the procedures included or referred to in the cargo operation manual requested in [2.1.2].

Before changing the setting value of the safety valves of one tank, the master is to make sure that the level in the tank is not above the maximum filling limit corresponding to the new setting pressure.

The level in the tank may be assessed by the following means:

- level switches
- level indicating devices
- level gauging devices.

Note 1: The master is to pay attention to the fact that the accuracy of the level indicating and level gauging devices may be impaired at sea due to the liquid motion in the tanks.

## 4.3 Boil-off gas management system

### 4.3.1 Normal navigation condition

In normal navigation condition, the cargo handling system of the ship is to be able to dispose at least 100% of the nominal boil-off gas rate.

### 4.3.2 Reduction of the boil-off gas disposal

Subject to the flag authorities agreement, the available capacity of the ship's boil-off gas handling system may be below the nominal boil-off gas rate during the following periods on condition that the pressure in the cargo tanks can be maintained below the set pressure of the safety relief valves for at least 21 days:

- when the gas engines are stopped or running at low load
- for the vessels fitted with a reliquefaction installation for boil-off gas disposal, when a part of this installation is out of service.

### 4.3.3 Capacity reduction of the boil-off gas handling system

During the periods the boil-off gas handling system is reduced in accordance to [4.3.2], the available capacity of the system is however not to be less than 50% of the NBOG.

The following arrangement may be considered:

- Ship equipped with gas engines and GCU: the capacity of the GCU is not to be less than 50% of NBOG
- Ship equipped with reliquefaction installation (without GCU): the reliquefaction installation is to consist of 2 trains, each having at least a 50% NBOG capacity
- Other arrangement where at least 50% of the NBOG can be handled at any time.

Note 1: The minimum reduced capacity of GCUs or reliquefaction installations may be required to be greater than 50% if necessary to achieve the 21 days condition stated in [4.3.2].

## 5 Control, monitoring and safety systems

### 5.1 Cargo tanks pressure alarms

5.1.1 Pressure alarms levels, and other associated parameters if any, are to be adjusted in the cargo control system when cargo tank relief valves settings are changed.

The selection on the console is to be carried out by means of a single switch with key lock which will select the appropriate pressure alarms and associated parameters.

The necessary information about these parameters is to be available at the request of the operators.

### 5.2 Indication of the cargo tanks pressure setting

5.2.1 A permanent indication of the setting of the pressure relief valves is to be displayed on the mimic diagrams on the appropriate screens.

## **6 Other**

### **6.1 Shop and gas trials**

**6.1.1** During the ship gas trials the functional test of the gas management system is to be carried out at the lower and at the higher set pressure of the pressure relief valves.

The functional test of the pressure relief valves for cargo tanks is to be carried out at manufacturer's test shop or at gas trials.

### **6.2 Ship to ship transfer**

**6.2.1** Means and/or measures are to be provided to prevent overpressure in the cargo tanks of the discharging or receiving ship.

## SECTION 15

## ENHANCED FIRE PROTECTION (EFP-AMC)

### 1 General

#### 1.1 Application

**1.1.1** The following additional class notations may be assigned, in accordance with Pt A, Ch 1, Sec 2, [6.14.18] to ships complying with the requirements of this Section:

- **EFP-A** for cargo ships and tankers having enhanced fire safety protection in accommodation spaces (see applicable requirements in Article [2])
- **EFP-M** for cargo ships, tankers and passenger ship having enhanced fire safety protection in machinery spaces (see applicable requirements in [3])
- **EFP-C** for cargo ships and tankers having enhanced fire safety protection in cargo area (see applicable requirements in [4])
- **EFP-AMC** for cargo ships and tankers complying with all the requirements of this Section.

### 2 Protection of accommodation spaces (EFP-A)

#### 2.1 Application

**2.1.1** This article is applicable to cargo ships and tankers having the additional class notation **EFP-A** or **EFP-AMC**.

#### 2.2 Prevention of fire

##### 2.2.1 Furniture in stairway enclosures

Furniture in stairway enclosures is to be limited to seating. It is to be fixed, limited to six seats on each deck in each stairway enclosure, be of restricted fire risk determined in accordance with the Fire Test Procedures Code, and is not to restrict the escape route. Furniture is not to be permitted in corridors forming escape routes in cabin areas. In addition to the above, only lockers of non-combustible material, providing storage for non-hazardous safety equipment required by the regulations, may be permitted.

#### 2.3 Detection and alarm

**2.3.1** A fixed fire detection and fire alarm system of addressable type is to be so installed and arranged as to provide smoke detection in service spaces, control stations and accommodation spaces, including corridors, stairways and escape routes within accommodation spaces. Heat detectors in lieu of smoke detectors may be installed in galleys and refrigerated spaces. Spaces having little or no fire risk such as voids, public toilets, private bathrooms, carbon dioxide rooms and similar spaces need not be fitted with a fixed fire detection and alarm system.

### 2.4 Containment of fire

#### 2.4.1 Method of protection in accommodation area

Only method of protection IC, in accordance with Pt C, Ch 4, Sec 5, [1.4.1], is to be adopted in accommodation and service spaces and control stations.

#### 2.4.2 Subdivision

- a) All divisional bulkheads, linings, ceilings in accommodation spaces, service spaces and control stations are to be of at least B-15 class. Private sanitary units are considered as part of the cabin in which they are located, and the corresponding bulkhead and door reduced to C-class division.
- b) Corridors in accommodation spaces are to be divided by self-closing class B-15 doors at a maximum distance of 20m from each other. When transversal corridors and longitudinal corridors are connected to each other, self-closing class B-15 doors are also to be provided if the total corridor length exceeds 20 m.

#### 2.4.3 Fire integrity of bulkheads and decks

- a) All decks in accommodation spaces, including corridors, and service spaces are to be of minimum A-0 class.
- b) All bulkheads and decks separating the accommodation spaces from machinery spaces, cargo holds and ballast and cargo pump rooms, as applicable, are to have an A-60 rating. This requirement does not apply to fire category 7 machinery spaces located within the accommodation spaces and only serving accommodation and service spaces, such as air conditioning spaces and service trunks.

#### 2.4.4 Doors in fire-resisting divisions

All doors fitted in the corridor bulkheads (providing access to cabins, public spaces, etc.) are to be of self-closing type. Service hatches and normally locked doors need not to comply with this requirement.

### 2.5 Escape

#### 2.5.1 Dead-end corridors

A corridor, lobby, or part of a corridor from which there is only one route of escape is prohibited. Dead-end corridors used in service areas which are necessary for the practical utility of the ship, such as fuel oil stations and athwartship supply corridors, are permitted, provided such dead-end corridors are separated from accommodation areas. Also, a part of a corridor that has a depth not exceeding its width is considered a recess or local extension and is permitted.

#### 2.5.2 Means of escape

Spaces exceeding 30 m<sup>2</sup> are to be provided with at least two means of escape, as widely separated as possible. Both

means of escape are to be a door having direct access to a corridor, a stairway or an open deck.

### 3 Protection of machinery spaces (EFP-M)

#### 3.1 Application

**3.1.1** This Article is applicable to ships having the additional class notation **EFP-M** or **EFP-AMC**.

#### 3.2 Machinery spaces general arrangement

##### 3.2.1 Segregation of thermal oil heaters and incinerators

Oil fired thermal oil heaters and incinerators are subject to the same segregation requirements as for purifiers (see Pt C, Ch 4, Sec 6, [4.1.2]). They are to be placed in a separate room, enclosed by steel bulkheads extending from deck to deck and provided with self-closing steel doors.

##### 3.2.2 Location of hydraulic power units

The requirement of Pt C, Ch 1, Sec 10, [14.3.3] is replaced by the following requirement:

- Hydraulic power units are to be located outside main engine or boiler rooms.

#### 3.3 Detection and alarm

##### 3.3.1 Fixed fire detection and fire alarm system

- All machinery spaces, including auxiliary machinery spaces, are to be covered by the fixed fire detection and fire alarm system.
- Fire detectors of more than one type are to be used for the protection of machinery spaces of category A. Flame detectors are to be provided in addition to smoke detectors, in way of engines, heated fuel oil separators, oil fired boilers and similar equipment.
- Smoke detectors located in workshops are to be connected to a timer function which automatically resets after maximum 30 minutes.

##### 3.3.2 TV monitoring system

Machinery spaces of category A are to be provided with a color TV monitoring system, covering all hot spots, such as engines with rated power above 375 kW, heated fuel oil separators, oil fired boilers and emergency diesel engine when it is used in port (Ch 2, Sec 3, [2.4]). Monitors are to be located in a manned control station or in an engine control room.

#### 3.4 Ventilation system

**3.4.1** In machinery spaces of category A, at least one exhaust ventilation fan is to have a supply from the emergency source of power, in order to permit, after a fire, the release of smoke and gaseous extinguishing agent, if any.

### 3.5 Fixed water-based local application fire-fighting system

**3.5.1** The fixed water-based local application fire-fighting system is to be provided with an automatic release.

**3.5.2** The system release is to be controlled by a combination of flame and smoke detectors. The detection system is to provide an alarm upon activation of any single detector and discharge if two or more detectors activate. The detection system zones are to correspond to the extinguishing system zones.

**3.5.3** The fixed water-based local application fire-fighting system is to be supplied from both the main and emergency source of power.

#### 3.6 Escape

##### 3.6.1 Escape from machinery control rooms, workshops and auxiliary machinery spaces

Two means of escape are to be provided from a machinery control room located within a machinery space, at least one of which will provide continuous fire shelter to a safe position outside the machinery space. This is also applicable to workshops, and, as far as practicable, to auxiliary machinery spaces.

#### 3.7 Central control station

##### 3.7.1 Cargo ships and tankers

Controls required:

- in items a) to d) of Pt C, Ch 4, Sec 2, [2.1.2]
- in Pt C, Ch 4, Sec 4, [3.2.1]
- in Pt C, Ch 4, Sec 5, [4.2.2], and
- the controls for any required fire-extinguishing system and CCTV system controls,

are to be located in a central control station, having a safe access from the open deck.

However, controls for release of the fixed fire-extinguishing system in machinery spaces of category A and controls for closing of oil fuel valves are to be readily accessible but may be located outside the central control station.

##### 3.7.2 Passenger ships

The controls for the TV monitoring system required in [3.3.2] are to be located in the safety centre required by Pt C, Ch 4, Sec 14.

### 4 Protection of cargo decks and cargo spaces (EFP-C)

#### 4.1 Cargo ships

##### 4.1.1 Application

This sub-article is applicable to dry cargo ships having the additional class notation **EFP-C** or **EFP-AMC**.

##### 4.1.2 Fire detection system

A fixed fire detection and fire alarm system complying with the requirements of Pt C, Ch 4, Sec 15 or a sample

extraction smoke detection system complying with the requirements of Pt C, Ch 4, Sec 15 is to be installed in all dry cargo holds.

#### 4.1.3 Fire fighting

Cargo spaces are to be protected by a fixed carbon dioxide or inert gas fire-extinguishing system, in compliance with Pt C, Ch 4, Sec 6, [6].

The exemption clause, as referred to in Pt C, Ch 4, Sec 6, [6.1.4], is not applicable to ships intended for the additional class notation **EFP-C** or **EFP-AMC**.

## 4.2 Ro-ro cargo ships and pure car and truck carriers

### 4.2.1 Application

This sub-article is applicable to ships having the additional class notation **EFP-C** or **EFP-AMC** and the service notation **ro-ro cargo ship** or **PCT carrier**.

### 4.2.2 Fire detection system

A fixed fire detection and fire alarm system of addressable type is to be so installed and arranged as to provide smoke detection in all ro-ro spaces.

## 4.3 Oil tankers, FLS tankers and chemical tankers

### 4.3.1 Application

This sub-article is applicable to ships having the additional class notation **EFP-C** or **EFP-AMC** and one of the following service notations: **oil tanker**, **FLS tanker** or **chemical tanker**.

### 4.3.2 Fire detection system in cargo pump rooms

A fixed fire detection and fire alarm system complying with the requirements of Pt C, Ch 4, Sec 15 and approved for use in gas hazardous atmosphere is to be so installed and arranged as to provide smoke detection in cargo pump rooms. Controls are to be located in the cargo control room, if any, and in the wheelhouse.

### 4.3.3 Fire main

The fire main on deck is to be arranged as a ring main laid to the port and starboard side. Isolation valves are to be globe valves of steel or fire safe butterfly valves. Main fire pumps are to be remote-controlled from the wheelhouse.

### 4.3.4 Foam system

- For oil tankers of less than 4000 GT, foam from the fixed foam system is to be supplied by means of monitors and foam applicators. Use of applicators only, as per Note 2 in Pt D, Ch 7, Sec 6, [3.2.1], item d), is not applicable.
- Tankers of 4000 GT and upwards need an independent foam main, arranged along the centre line as a single line with foam outlet branches to both port and starboard arranged just aft of each monitor. At least two foam mixing units and two foam concentrate pumps are to be provided, placed together with the storage tank for foam concentrate in a dedicated room. Foam concen-

trate sufficient for 30 minutes of continuous foam production are to be stored onboard. Two foam monitors at each side of the accommodation front and monitors covering the cargo manifold are to be remote-controlled from the bridge or from another safe area with a good visibility to the monitors coverage area.

### 4.3.5 Water-spray protection of lifeboats

If lifeboats are not separated by steel bulkheads from the cargo area, a manual water spraying system giving an effective average distribution of water of at least 10 l/min/m<sup>2</sup> over the sides and top of each lifeboat is to be provided. It may be taken from the fire main with the isolating valve located outside the protected area, if the capacity of the fire pumps is sufficient for simultaneous activation of the water-spraying system and the fire main system. In any case, the system is to be remote-controlled from the wheelhouse.

### 4.3.6 Inert gas system

An inert gas system complying with Pt D, Ch 7, Sec 6, [5] or Pt D, Ch 8, Sec 9, [2], as applicable, is to be provided for all tankers having additional class notation **EFP-C** or **EFP-AMC**, even if less than 8000 DWT. This is however not applicable to oil tankers having the additional service feature **flash point > 60°C**.

## 4.4 Liquefied gas carriers

### 4.4.1 Application

This sub-article is applicable to ships having the additional class notation **EFP-C** or **EFP-AMC** and the service notation **liquefied gas carrier** or **LNG bunkering ship**.

### 4.4.2 Fire detection system

A fixed fire detection and fire alarm system complying with the requirements of Pt C, Ch 4, Sec 15, [8] and approved for use in gas hazardous atmosphere is to be so installed and arranged as to provide smoke detection in enclosed spaces / areas containing cargo handling equipment, such as compressor and pump rooms, reliquefaction room, regasification spaces, and electric motor room within the cargo area. Controls are to be located in the wheelhouse.

### 4.4.3 Fixed fire-extinguishing system in electrical rooms

Enclosed spaces/areas containing cargo handling equipment, such as compressor and pump rooms, reliquefaction room, regasification spaces, and electric motor room within the cargo area should be provided with a fixed gas fire extinguishing system complying with the requirements of Pt C, Ch 4, Sec 15, [4] taking into account the necessary concentrations required for extinguishing gas fires or water mist fire extinguishing system complying with the requirements of Pt C, Ch 4, Sec 15, [6].

### 4.4.4 Fire main

The fire main on deck is to be arranged as a ring main laid to the port and starboard side. Isolation valves are to be globe valves of steel or fire safe butterfly valves. Main fire pumps are to be remote-controlled from the wheelhouse.

#### 4.4.5 Dry chemical powder fire-extinguishing system

The dry chemical powder fire-extinguishing system complying with the requirements of Pt D, Ch 9, Sec 11, [1.4.2] is subject to the following additional requirement:

- Sufficient dry powder quantity is to be stored on board to provide 60 s operation.

#### 4.4.6 Fire extinguishing arrangement in vent mast of gas carriers

A fixed system for extinguishing a fire at the vent outlet is to be provided inside venting masts for cargo tank venting system. Nitrogen, CO<sub>2</sub> or any other suitable medium is acceptable.

#### 4.4.7 Water-spray protection of lifeboats

If lifeboats are not separated by steel bulkheads from the cargo area, a manual water spraying system giving an effective average distribution of water of at least 10 l/min/m<sup>2</sup> over the sides and top of each lifeboat is to be provided. It may be taken from the fire main with the isolating valve located outside the protected area, if the capacity of the fire pumps is sufficient for simultaneous activation of the waterspraying system and the fire main system. In any case, the system is to be remote-controlled from the wheelhouse.

## 5 Onboard testing

### 5.1 Hot spot verification

#### 5.1.1

Compliance with the requirements of Pt C, Ch 1, Sec 1, [3.7.1] is to be confirmed through thermal imaging scanning of engines, boilers, steam, thermal oil and exhaust gas lines, silencers, exhaust gas boilers and turbochargers or other equipment where hot surfaces above 220 °C may be expected. This verification is to be carried out with the engines or concerned equipment under steady and normal operating conditions.

5.1.2 Thermal imaging measurements are to be performed:

- in accordance with a recognized methodology accepted by the Society
- with suitably calibrated equipment
- by qualified personnel.

The society may require that the measurements be witnessed by a surveyor.

# SECTION 16 SINGLEPASSLOADING

## 1 General

### 1.1 Application

**1.1.1** The additional class notation **SINGLEPASSLOADING** may be assigned to ships having the service notation **ore carrier** which are specially designed for single pass loading. This additional class notation may be completed by the design loading rate in tons per hour, for example: **SINGLEPASSLOADING [16000 t/h]**.

**1.1.2** The additional class notation **SINGLEPASSLOADING** only covers the loading sequences provided to the Society, as referred to in [2.2.1].

### 1.2 Definitions

#### 1.2.1 Loading sequence

The loading sequence is the step-by-step description of the loading process of the ship starting from empty condition (no cargo in holds) and ending at the fully loaded condition. The loading sequence is to include the description of the necessary de-ballasting operations.

#### 1.2.2 Loading step

A loading step is one step of the loading sequence. The step begins when the considered empty cargo hold starts to be filled up and ends when this cargo hold reaches its final filling. In case of multiple loaders acting simultaneously the loading step begins when the considered empty cargo holds start to be loaded and ends when these holds reach their final filling.

#### 1.2.3 Loading rate

The loading rate is defined as the total mass of cargo divided by the time needed for the ship to be entirely loaded during active filling operations, and is expressed in t/h (tons per hour).

#### 1.2.4 Design loading rate

The design loading rate is the maximum loading rate, in t/h, for which the ship is designed.

#### 1.2.5 Single pass loading

The ship can be loaded from empty (ballast) condition up to the fully loaded condition by filling each cargo hold to the maximum permissible cargo mass in a single pour.

**1.2.6** Mistiming the loading of cargo may result in cargo overloading, also called overshooting.

This phenomenon is prevented through means of control and monitoring, as required in [4.3] and [5.3].

In case an additional margin is requested by the designer or the owner, the requirements in [4.2.5] are to be complied with.

## 2 Documentation to be submitted

### 2.1 Design loading rate

**2.1.1** The design loading rate is to be defined by the designer and submitted to the Society. Its value is to be indicated in the loading manual. Unless otherwise specified, the design loading rate is to be taken as 16000 t/h.

### 2.2 Loading sequences

**2.2.1** Applicable loading sequences are to be submitted by the designer to the Society for review. These loading sequences are to describe every loading step from empty (ballast) condition up to the ship's final loading condition. If multiple loaders are used, the corresponding information is to be detailed. Typical final loading conditions to be considered include homogeneous loading conditions, alternate loading conditions and part loading conditions, as applicable.

**2.2.2** For any considered loading sequence, the following information is to be provided at the initial stage (empty condition) and at the end of each loading step:

- cargo hold mass of each cargo hold
- ballast tanks filling levels
- longitudinal distribution of still water bending moment and shear force. The corresponding values are to be given at least at the transverse cargo bulkheads and at mid-hold positions
- trim and draught of the ship (mean, aft and fore)
- metacentric height, corrected for free surface effects.

### 2.3 Hold mass curves

**2.3.1** Hold mass curves for each single cargo hold are to be provided in the loading manual. The curves are to show the maximum allowable and minimum required mass of cargo and double bottom contents (e.g. ballast water) of each cargo hold as a function of the draught at mid-hold position (for determination of the permissible mass in a single cargo hold, refer to Pt B, Ch 10, App 1).

**2.3.2** Hold mass curves for any two adjacent cargo holds are to be provided in the loading manual. They are to show the maximum allowable and minimum required mass of cargo and double bottom contents of any two adjacent cargo holds as a function of the mean draught in way of these cargo holds. This mean draught may be obtained averaging the draughts at both mid-hold positions (for determination of permissible mass in two adjacent cargo holds, refer to Pt B, Ch 10, App 1).

Note 1: In the context of single pass loading all loading steps are to be related to the hold mass curves in harbour condition, while only the initial (ballast) and final (fully loaded) step are to be related to the hold mass curves in seagoing condition.



### 3 Loading instrument and alternative loading

#### 3.1 Loading instrument

**3.1.1** The ship loading instrument is to ascertain that:

- the mass of cargo and double bottom contents remains within the limits defined by the hold mass curves
- the resulting still water bending moment and still water shear force remain within the permissible values, as applicable in port conditions.

#### 3.2 Alternative loading

**3.2.1** If any deviation from the approved loading sequence is deemed necessary by the Master, it is to be carried out in compliance with the relevant requirements of SOLAS Ch VI Reg.7.3. To this end a new loading plan is to be agreed with the loading terminal.

## 4 Hull requirements

#### 4.1 General

**4.1.1** The Master is to ensure that the ship's manoeuvring capability upon arrival in the loading port in (light) ballast condition is adequate for berthing at the designated loading terminal, taking into consideration the environmental conditions (e.g. wind, waves and current) and the port lay-out (e.g. available space for turning and air draught).

**4.1.2** During each loading step, the de-ballasting operations are to be completed within the same time as the cargo loading operations.

#### 4.2 Hull structure

**4.2.1** The hull girder strength and local strength are to comply with the relevant requirements of Part B during each loading step of the applicable loading sequences, as defined in [2.2.1]. Intermediate stages of loading and de-ballasting are to be taken into consideration to ensure that the most severe situation during the loading step is covered.

**4.2.2** The ship structure is to withstand the design loading rate, as defined in [2.1].

**4.2.3** During each loading step, the filling level in each cargo hold is to remain within the permissible limits of the applicable hold mass curves as defined in [2.3].

**4.2.4** The inner bottom is to comply with the requirements for the additional class notation **GRABLOADING**, as defined in Ch 11, Sec 2.

**4.2.5** In case an extra margin is requested by the designer or the owner to cover for overshooting, the following is to be complied with:

- An extra amount of cargo, in t, taken equal to the product of the design loading rate, in t/h, and the maximum

overshooting time, in h, as specified by the designer is to be considered in one cargo hold at a time for the following assessments, in both sea-going and harbour conditions:

- local scantling of cargo hold bulkheads (plating and stiffeners)
- partial cargo hold FE analysis.
- In addition, the corresponding loading conditions are to be provided in the loading manual and shall prove that the related still water hull girder loads remain within the allowable values.

#### 4.3 Control and monitoring

**4.3.1** An automatic draught reading system, feeding draught and trim data to the loading computer, is to be provided. Readings are also to be provided in the cargo loading station.

## 5 System requirements

#### 5.1 General

**5.1.1** The ship is to be fitted with a de-ballasting system and a separate stripping system having a capacity consistent with the design loading rate.

**5.1.2** Arrangements are to be made for synchronizing the de-ballasting rate with the loading rate, as well as in time starting of the stripping operations.

**5.1.3** Where provided, the ballast water treatment system is to be designed for the maximum expected de-ballasting rate.

#### 5.2 Ballast piping

**5.2.1** Ballast main and branch lines are to have sufficient diameter so that the sea water velocity in those lines does not exceed the limits stated in Pt C, Ch 1, Sec 10, [5.8.3], in all de-ballasting configurations (depending on the number of ballast pumps in operation and number of ballast tanks served simultaneously).

#### 5.3 Control and monitoring

**5.3.1** Ballast pumps and all valves necessary for the de-ballasting and stripping operations are to be capable of being controlled from the cargo loading station and / or ballast control station.

**5.3.2** Ballast tanks are to be fitted with level sensors feeding tank sounding levels to the loading computer and providing a remote indication in the cargo loading station.

**5.3.3** Fuel oil tanks for storage of bunkers are to be fitted with level sensors feeding tank sounding levels to the loading computer and providing a remote indication in the cargo loading station.

## SECTION 17

# BOW AND STERN LOADING / UNLOADING SYSTEMS

### 1 General

#### 1.1 Application

**1.1.1** The requirements of the present Section are applicable for oil tankers fitted with bow or stern loading/unloading systems and intended to be granted class notations defined in [1.2].

**1.1.2** The requirements of the present Section are to be considered in addition to the applicable requirements of Part D, Chapter 7.

#### 1.2 Class notations

##### 1.2.1 Additional class notation **BLUS**

Oil tankers equipped with bow loading/unloading systems and complying with the requirements of the present Section may be granted the additional class notation **BLUS**.

##### 1.2.2 Additional class notation **SLUS**

Oil tankers equipped with stern loading/unloading systems and complying with the requirements of the present Section may be granted the additional class notation **SLUS**.

#### 1.3 Scope of classification

**1.3.1** Additional class notations **BLUS** and **SLUS**, as defined in [1.2] cover classification requirements relating to the following equipment and items:

- general arrangement of bow or stern loading/unloading systems
- cargo transfer piping for bow or stern loading/unloading systems
- relevant mooring arrangements
- traction winches and storage reel
- bow and stern control stations
- fire protection of areas relating to bow or stern loading/unloading systems
- ventilation of spaces in relevant bow or stern areas.
- electrical equipment for bow or stern loading/unloading systems
- instrumentation and automation for bow or stern loading/unloading systems.

**1.3.2** All equipment covered by additional class notations **BLUS** and **SLUS** is to be function tested.

### 1.4 Definitions

#### 1.4.1 Oil tanker

For the purpose of the present Note, oil tanker means a ship with service notation **oil tanker**, as defined in Pt A, Ch 1, Sec 2, [4].

#### 1.4.2 Hazardous areas

Hazardous areas are areas where flammable or explosive gases are normally present or likely to be present. Hazardous areas are categorized as Zone 0, Zone 1 and Zone 2, as defined in Pt C, Ch 2, Sec 1, [3.24].

Detailed definitions of hazardous areas are given as follows in Pt D, Ch 7, Sec 5.

#### 1.4.3 Cargo area

*The cargo area is that part of the ship that contains cargo tanks as well as slop tanks, cargo pump rooms including pump rooms, cofferdams, ballast or void spaces adjacent to cargo tanks or slop tanks as well as deck areas throughout the entire length and breadth of the part of the ship above these spaces.*

When independent tanks are installed in hold spaces, the cofferdams, ballast or void spaces at the after end of the aftermost hold space or at the forward end of the forwardmost hold space are excluded from the cargo area.

### 1.5 Documents to be submitted

#### 1.5.1 General

In addition to the documentation requested by the Ship Rules, the following documents are to be submitted:

- general arrangement of bow or stern loading/unloading systems and mooring arrangements, including loading/unloading manifold, traction winch, storage reel, fairleads and chain stoppers, relevant control stations
- hazardous area plan and electrical equipment data
- plans showing fire protection and fire extinguishing arrangements for the bow or stern loading/unloading areas
- ventilation of spaces in bow or stern areas
- spill containment arrangements
- details of cargo piping from the cargo area to loading/unloading manifold, including standard construction details
- operating manual.

## 1.6 Operating Manual

**1.6.1** An Operating Manual is to be submitted to the Society, for approval, as requested in [1.5.1].

**1.6.2** The Operating Manual is to provide, at least, the following information relating to ship operation:

- mooring procedure including specific operation of mooring related equipment
- connection / disconnection of hose coupling
- emergency disconnection procedure
- cargo transfer
- specific loading conditions including cargo load distribution
- cleaning and gas-freeing
- provisions for avoiding overfilling of cargo tanks.

**1.6.3** The Operating Manual is to provide references to drawings relating to relevant arrangements, equipment, safety installations, emergency escape routes.

## 2 Materials

### 2.1 General

**2.1.1** Material for construction are to comply with the requirements of NR 216 Material and Welding.

**2.1.2** Unless otherwise specified, materials for cargo piping are to comply with the requirements of Pt C, Ch 1, Sec 10 applicable to piping systems of class III.

The requirements of Pt D, Ch 7, Sec 4, [3.3.2] are also to be taken into account.

## 3 General design

### 3.1 Mooring system

**3.1.1** Mooring equipment are to be designed in accordance with relevant requirements given in Pt B, Ch 9, Sec 4.

**3.1.2** Mooring system is to be provided with a device indicating continuously the tension in lines during loading/unloading operations.

**3.1.3** The requirement of [3.1.2] may be waived for ships fitted with a dynamic positioning system for operations and intended to be assigned the additional class notation **DYNAPOS**, as defined in Pt A, Ch 1, Sec 2, [6].

**3.1.4** Mooring system instrumentation is to include chain stopper control and mooring lines control.

### 3.2 Cargo piping system

**3.2.1** Cargo piping outside cargo area is to be fitted with a shut-off valve at its connection with the piping system within the cargo area and separating means such as blank flanges or removable spool pieces are to be provided when the piping is not in use, irrespective of the number and type of valves in the line.

**3.2.2** Connection with shore or offshore unit is to be fitted with a shut-off valve and a blank flange. The blank flange may be omitted when a patent hose coupling is fitted.

**3.2.3** Cargo lines outside the cargo area are to be installed outside accommodation spaces, service spaces, machinery spaces and control stations.

**3.2.4** Pipe connections outside the cargo area are to be of welded type only, except for connections with manifold or loading/unloading equipment.

**3.2.5** Spray shields are to be provided at the connection station, except where the loading/unloading manifold is located outboard. Spill containment arrangements with sufficient capacity are to be provided under the loading/unloading manifold.

**3.2.6** Cargo lines outside cargo area are to be provided with arrangements for easy draining to the cargo area, in a cargo tank.

**3.2.7** Loading/unloading lines are to be fitted with means to be purged by inert gas after use and maintained gas free when not in use. Due consideration is to be given to isolation between cargo and the inert gas system.

### 3.3 Ventilation

**3.3.1** Air inlets, entrances and openings to machinery spaces, service spaces and control stations are to be located at least 10 m from the coupling and are not to be located facing the cargo hose connection.

**3.3.2** For ships intended to be assigned the additional notation **SLUS**, due consideration is to be given to the location of ventilation inlets and outlets of machinery spaces and openings of deckhouses and superstructure boundaries.

### 3.4 Hazardous areas and electrical installations

**3.4.1** Spaces used for housing loading/unloading hoses, cargo lines and loading/unloading manifold are to be considered as hazardous area Zone 1.

**3.4.2** Spaces within 3 m from the boundary of spill containment arrangements are to be considered as hazardous, Zone 1.

**3.4.3** Electrical equipment and cables located in hazardous areas are to be of a certified safe-type and are to comply with the requirements of Pt D, Ch 7, Sec 5.

### 3.5 Positioning

**3.5.1** Ship positioning and manoeuvring during loading/unloading operations is to be ensured by:

- controllable pitch propeller
- side thrusters of adequate power.

**3.5.2** For ships fitted with dynamic positioning system, the requirements given under the scope of additional class notation **DYNAPOS** are to be complied with.

### 3.6 Emergency Disconnection System (EDS)

**3.6.1** Bow or stern loading/unloading systems are to be provided with an automatic EDS and a back-up EDS.

**3.6.2** Functions of automatic EDS are to be performed in sequence and are to include:

- tripping of transfer pumps
- emergency closing of valves
- coupler disconnection
- mooring system release.

**3.6.3** The back-up EDS is to be manually operated, allowing the individual operation of coupler and mooring system.

### 3.7 Control station

**3.7.1** A control station from which are performed all operations relating to ship positioning and monitoring of mooring and loading/unloading parameters is to be arranged in the relevant bow or stern area or on the navigation bridge.

**3.7.2** Boundaries of the control station, including windows and side scuttles, are to be of A-60 insulated.

**3.7.3** Adequate emergency escape routes are to be provided for the control station.

### 3.8 Communications

**3.8.1** Means of communication, such as telephones, two-way portable radios, etc, are to be provided onboard between the control station and shore or offshore unit. Means of emergency communication are also to be provided.

**3.8.2** Means of communication are to be such that the communication can be maintained in the eventuality of any equipment failure or incidents during loading/unloading operations.

**3.8.3** Means of communication in hazardous areas are to be of a certified safe-type.

**3.8.4** A communication sequence is to be established for all phases of loading/unloading operation.

### 3.9 Safety features

**3.9.1** The layout of bow or stern loading/unloading system is to be based on the principle of the minimization of risk and consequences of relevant fire and explosion events relating to bow or stern areas.

**3.9.2** The following additional safety equipment is to be provided, as a minimum:

- protection of mooring elements against shocks and contact with hull elements
- protection of hose coupling against shocks and contact with hull elements
- additional water jets and foam monitors for bow or stern area, at the satisfaction of the Society
- a fixed foam fire extinguishing system, at the satisfaction of the Society, covering loading/unloading areas
- a fixed water spray system covering the area of mooring elements, hose couplings and control station area.

**3.9.3** Bow or stern loading/unloading system is not to interfere with the safe launching of survival craft. Provisions are to be made to protect launching stations from sprays in case of hose and pipe bursting.

## SECTION 18 SUPPLY AT SEA (SAS)

### 1 General

#### 1.1 Application

**1.1.1** The additional class notation **SAS** is assigned in accordance with Pt A, Ch 1, Sec 2, [6.14.25], to ships having the service notation **supply** fitted with installations for underway ship-to-ship supply at sea of liquid and solid supplies, complying with the requirements of this Section.

Specific operation may be added if relevant (e.g. **SAS** - seismic support).

**1.1.2** The requirements of this Section apply in addition to the requirements of Part E, Chapter 3.

**1.1.3** Application to other types of ship may be considered on a case-by-case basis.

#### 1.2 Documents to be submitted

**1.2.1** The plans and documents to be submitted to the Society are listed in Tab 1.

#### 1.3 Definitions

##### 1.3.1 Supply At Sea (SAS)

SAS means refuelling at sea or underway provisioning at sea of solid and liquid supplies.

##### 1.3.2 SAS station

SAS station is the deck area fitted with SAS equipment providing the capability to carry out underway provisioning of liquid and/or solid cargo.

##### 1.3.3 SAS control station

SAS control station is a station from which it is possible to operate SAS equipment and observe the SAS operations performed at SAS station(s).

**Table 1 : Documentation to be submitted**

No.	I/A (1)	Documents to be submitted
1	I	Description and operation manuals of the ship's SAS systems and equipments, including limiting conditions for SAS operations
2	A	Plans showing each proposed combination of equipment, fully rigged
3	I	Details of solid cargo to be transferred: maximum weight and dimensions
4	A	Details of liquid cargo to be transferred and diagram of the fluid transfer system
5	I	Details of maximum sea state and environmental conditions under which SAS operations are permitted
6	I	General arrangement showing: <ul style="list-style-type: none"> <li>• relative disposition of SAS stations and associated clearances</li> <li>• location of SAS control stations</li> <li>• arrangement of solid cargo transfer routes</li> </ul>
7	A	Lifting appliances: plans and construction drawings of all lifting appliances, masts, derricks, rigs
8	I	Mooring plan, including details and SWL of lines, bitts, fairleads and winches to be used
9	A	Details of equipment identified for SAS operations. Design and installation loads on the equipment together with details of securing and holding down arrangements. Details of the access required for maintenance and to operate the equipment
10	I	Description of safety devices (emergency breakaway, antislack devices, alarms, limit switches...)
11	A	Drawings of the foundations of lifting appliances and winches, including footprint and reaction forces
12	I	National or international regulations, standards or specifications used for type testing of equipment requiring type testing according to Tab 3
13	I	SWL of all components of SAS installation
14	A	Test and inspection programme for the test onboard: static load test, checking verifications, dynamic overload tests
15	A	Details of structural reinforcement under SAS stations dump areas
16	A	Diagram of internal ship communication system
17	I	Diagram of ship to ship communication system
18	I	Arrangement plan of low intensity lightning of SAS stations and transfer routes
<p>(1) I : To be submitted for information. A : To be submitted for approval.</p>		

## 2 Design and construction

### 2.1 SAS equipment

#### 2.1.1 Typical arrangement

Solid supply installations are generally made of:

- support line and inhaul line with their necessary associated items (hooks, derricks, mast...) to run the traveller block manually or by means of winches between delivery ship and receiving ship, or
- on-board cranes.

Liquids supply installations are generally made of:

- hose lengths secured by saddles to the support line with their necessary associated items (hooks, derricks, mast...) and run between both ships by means of winches, or
- floating hoses running between both ships (stern transfer).

Other types of SAS installations may be used and are to be submitted to the Society for special examination.

#### 2.1.2 General

SAS pieces of equipment onboard supply vessels are to comply with the following requirements:

- they are to be type approved according to [4.1]
- certificates of inspection of materials and equipment are to be provided as indicated in [4.2]
- fitting onboard of the SAS equipment is to be witnessed by a Surveyor of the Society and the relevant certificate is to be issued
- demonstration of the strength, structural integrity and good working of SAS equipment is to be effected for each ship through shipboard testing as mentioned in [4.4] and this is to be reported in the above certificate.

#### 2.1.3 Emergency breakaway

All SAS equipment and facilities are to be designed to permit the application of emergency breakaway procedures that are normally to be complete within one minute of the commencement of initiation. Use may be made of quick release couplings and/or breakable couplings. Attention is to be given to the attachment of wires and ropes to winch drums and the selection of emergency breakaway equipment (wire cutters, axes, etc.).

#### 2.1.4 Prevention measures

Fenders are to be provided to protect the ship from ship-to-ship contact during SAS operations.

Measurements are to be taken to prevent electrostatic hazards during liquids transfer operation.

#### 2.1.5 Survey of elements within the scope of ship classification

The fixed parts of the SAS equipment and connections to ship structure (masts, crane pedestals, winches and equipment foundations, local reinforcements under the dump area and transfer lanes) are to be surveyed at the yard by a Surveyor of the Society within the scope of the ship classification.

#### 2.1.6 Safe Working Load (SWL) of SAS equipment

The safe working load of SAS components is to be sufficient to withstand the maximum load to which such component may be subjected during the SAS operation. The safe working load is to be indicated by the designer.

For tensioned spanwire, the SWL of the rigging components is the maximum design tension of the spanwire given by the designer.

As a rule, the SWL of the components which are not part of the tensioned line (i.e. riding and retrieving lines) is not to be less than 35 kN.

#### 2.1.7 Winches

Winches are to incorporate safety features that permit safe SAS operations and cater for the unique loading conditions that may arise during SAS operations. The following functions are to be fulfilled:

- Quick and efficient engagement and disengagement of the service brake by both automatic and manual means
- Long term locking of the winch drum having manual engagement and disengagement
- For spanwire and retrieving winches:
  - an overload protection preventing the wire/rope being overstressed during SAS operations (e.g. when ships move or roll apart)
  - slack rope prevention that maintains tension in the wire when the winch is operating under no load
- Proper spooling of the wire onto the drum
- Winches are to be fed by an alternative power supply.

Combined stress resulting from application in the most unfavourable conditions of a tension in the cable equal the breaking load of this cable is not to be higher than 80% of the comparison elastic limit of the material of which strength elements such as frame, drum, drum axles, assembly welds, etc. are made.

Minimum braking force of service brakes is not to be less than 1,5 times the safe working force on the brake.

#### 2.1.8 Steel wire ropes

Steel wire ropes used for SAS operations are to be in compliance with requirements of NR216 Materials and Welding, Ch 4, Sec 1, [4].

The ratio of the specified breaking load of the cable to its SWL is not to be taken less than 3,5.

#### 2.1.9 Hoses and fittings

Hoses for transferring liquids are to be in accordance with standards applicable to the intended application.

#### 2.1.10 Masts

Masts, cranes, derricks and rigs used for SAS operations and fenders positioning are to comply with the relevant requirements of NR526 Rules for Lifting Appliances, considering the most unfavourable combination of all safe working loads applied to the mast.

### 2.1.11 Shipboard fittings and supporting hull structures associated with mooring

Mooring lines are only to be led through class approved closed fairleads.

Additional lines are to be readily available to supplement moorings if necessary or in the event of a line failure.

It is recommended to use all available fairleads and bitts to avoid concentration of loads.

The requirements of Pt B, Ch 9, Sec 4, [4.2] are applicable.

## 2.2 Steering capability

### 2.2.1 General

The steering gear system is to fulfil the requirements defined in Pt C, Ch 1, Sec 11.

### 2.2.2 Electrical power supply

An alternative power supply either from the emergency source of electrical power or from an independent source of power located in the steering gear compartment is to be provided, sufficient at least to supply the steering gear power unit such that the latter is able to perform the duties of auxiliary steering gear.

This power source is to be activated automatically, within 45 seconds, in the event of failure of the main source(s) of electrical power.

The independent source is to be used only for this purpose.

The alternative power source is also to supply the steering gear control system, the remote control of the power unit and the rudder angle indicator.

### 2.2.3 Steering control systems

Any single failure in the steering control system including its interfaces to the navigation system is not to impair the steering capability which is to be continuously maintained.

Such single failure may affect any active component as defined in Pt E, Ch 2, Sec 1, [1.2.5] from interfaces to the navigation system to interfaces to the mechanical steering actuators.

Compliance with the above is to be demonstrated by a risk analysis performed in compliance with Pt E, Ch 2, App 1, Procedures for Failure Modes and Effect Analysis.

A dynamic positioning system, with **DYNAPOS AM/AT R** notation, could be considered as an alternative regarding the availability of the steering system.

## 3 Arrangement and installation

### 3.1 General

**3.1.1** SAS systems are to be designed and installed such that degradation or failure of any SAS system will not render another ship system inoperable.

## 3.2 Arrangement of SAS stations

### 3.2.1 Location of SAS stations

The distance separating two alongside SAS stations, if any, is recommended not to be less than 20 m and not to exceed 40 m.

As far as practicable, one side SAS station is to be located amidships to maximise crew protection during SAS operations in heavy weather conditions.

### 3.2.2 Clearance requirements

A clearance of at least 30° aft and forward of each side SAS station is to be provided.

For the stern station, if any, sufficient clearance is to be provided for safe deployment of refuelling equipment with regard to deck and stern equipment.

### 3.2.3 Protection of personnel

- a) Bulwarks, guard rails or other equivalent arrangement are to be provided in exposed upper deck positions with regard to personnel protection, in accordance with Pt B, Ch 9, Sec 2.
- b) In general, SAS operations are to be carried out with guard rails in position. Where, for operational reasons, this is not practicable, alternative equivalent arrangements are to be provided.
- c) Slip-free surfaces are to be provided in the areas where SAS operations are conducted, and tripping hazards are to be minimized.
- d) A minimum distance of at least 3 m between any SAS station superstructure and the edge of the weather deck is to be provided.

In case this distance is practically not achievable, specific measures are to be described in order to provide protection to personnel (individual protection, maximum size of solid loads transferred, marks on SAS area, procedures used, limitation of operations according to weather conditions ...)

- e) Authorised personnel only is allowed at the SAS station. During liquid transfer operation, authorised personnel is to be equipped with protective clothing

### 3.2.4 Access

The rigging securing points are to be arranged so that safe access is provided to authorised personnel, including ladders and walkways on the masts.

### 3.2.5 SAS equipment stores

SAS equipments and fittings are to be stored in dedicated stores, readily accessible from authorised personnel SAS station. The stores are to have direct access to the weather deck.

### 3.2.6 Sources of high intensity noise

SAS stations are to be arranged so that exposure to high intensity noise (above 85 dB) is as low as practicable during SAS operations.

### 3.3 SAS control station arrangement

#### 3.3.1 General

- A SAS control station is to be provided for control and monitoring of all equipment involved in SAS operations as requested in [3.4] and [3.5].
- The controls for SAS equipment are to be situated at one control position or grouped in as few positions as possible, to the satisfaction of the Society.
- For liquid transfer, the SAS control station is to be located at a safe distance from the filling connection.
- The SAS control station is to be located so that it provides a clear view of all SAS stations and associated equipment.
- The SAS control station is to be permanently manned during transfer operations.

### 3.4 Communication

#### 3.4.1 Bridge conning position

A conning position for the officer in charge of the SAS operations is to be provided on the navigating bridge with a duplicated position on both bridge wings.

From this conning position, it is to be possible to observe the ship heading and relative motion of the ships conducting SAS operations. In addition, a gyro compass readout and rudder angle indicator are to be readily visible from the conning position.

#### 3.4.2 Ship internal communication systems

Means of communication are to be provided between each SAS station and the SAS control station.

Such communication system is to be such that communication between SAS stations and SAS control station can be maintained in case of equipment single failure.

As a minimum, means of effective ship internal communications are to be provided in accordance with Tab 2.

#### 3.4.3 Ship to ship communications

- Means are to be provided to allow continuous ship to ship distance measurement during side by side SAS operations.
- Visual and aural means of communication are to be provided between the ships conducting SAS operations.
- If some equipment, such as distance line, is to be transferred from one ship to another in order to conduct the SAS operations, the distance line securing points are to

be clear of all SAS stations and arranged so that the distance line is visible from the bridge conning position. This requirement may be waived for stern replenishment.

### 3.5 Fluid transfer

#### 3.5.1 General

- The filling connections for liquid transfer operations are to be located within the SAS station and are to be fitted with shut-off valves locally operated.
- Filling connections are to be designed to allow an emergency breakaway as per [2.1.3]. In particular, they are to be provided with quick release coupling.
- Filling connections are to be provided with pressure sensors monitored from the SAS control station.
- Emergency stop of the cargo pumps are to be provided at the SAS control station.

#### 3.5.2 Quick release system

When transferring liquids with flash point not greater than 60°C, adequate means are to be provided to rapidly stop the liquid transfer operation if abnormal situation occurs. This system is to operate at two levels:

- stage 1: shut down of cargo pumps and shutting of quick closing valves. Emergency stop is to be provided at SAS control station and at bridge conning position.
- stage 2: release of the quick release couplings.

The quick release system may be connected to the ships automatic emergency breakaway system (if any) but, in all cases, is also to be capable of manual activation.

The means of control of the quick release system are to be located at the SAS control station together with the controls for any safety system that may provided additional protection to the ship in the event of a quick release (e.g. deck foam system ...).

In the event of activation of the quick release hose couplings, the hoses are to be adequately supported and protected to prevent potential damage or rupture.

#### 3.5.3 Fire extinguishing arrangement

A SAS station is to be provided with:

- two dry powder fire-extinguishers, each of at least 50 kg
- at least one portable low expansion foam applicator.

**Table 2 : Internal communications**

Position	Conning position	SAS station	SAS control station	Remarks
Conning position		X	X	
SAS station	X		X	Each SAS station is to be able to communicate with the conning position and the SAS control station
SAS control station	X	X		



### 3.6 Solid transfer

#### 3.6.1 General

To prevent ingress of water into the ship, sills or alternative equivalent arrangements are to be provided at the entrances to the interior of the ship from each SAS station.

#### 3.6.2 Ship structure

- a) Each SAS station intended for solid transfer operations is to be provided with a designated dump area.

The dump area is to be suitably reinforced to withstand the impact loads that may arise due to landing of stores and equipment on board during SAS operations.

- b) The dump area is to extend over at least 1 m outside of the largest expected solid cargo foot print. A factor of safety of not less than 3,5 times the maximum load to be transferred is to be used in the design of the structure.

### 3.7 Electrical installation

**3.7.1** The following additional hazardous areas are to be considered when transferring flammable liquids having a flash point not exceeding 60°C or flammable liquids heated to a temperature within 15°C of their flash point:

- Zone 1: Enclosed or semi-enclosed spaces containing SAS equipment unless:
  - fitted with forced ventilation capable of giving at least 20 air changes per hour and having characteristics such as to maintain the effectiveness of such ventilation, or
  - acceptable means are provided to drain or empty the hoses or rigid arms on completion of transfer operations, prior to or after disconnection
- Zone 2: Areas in open deck within 3 m from SAS equipment unless acceptable means are provided to drain or empty the hoses or rigid arms on completion of transfer operations and after disconnection.

Types of electrical equipment allowed within these areas are specified in Pt C, Ch 2, Sec 3, [10].

**3.7.2** All the deck mounted electrical equipment and enclosures are to be designed with IP56 ingress protection rating.

#### 3.7.3 Night operation

In order to carry out SAS operation at night in safe conditions, sufficient lighting, including emergency lighting, is to be provided on SAS areas and at control station.

## 4 Certification, inspection and testing

### 4.1 Type approval procedure

**4.1.1** SAS components are to be type approved according to the following procedure:

- the design is to comply with the requirements of this Section and either national or international standards, or recognized codes or specifications, which are to be indicated

- each component of the SAS equipment is to be tested and its manufacturing is to be witnessed and certified by a Surveyor according to [4.3]
- type tests are to be carried out as specified under [4.4].

### 4.2 Inspection at works of the SAS equipment

**4.2.1** The materials and equipment are to be inspected and certified as specified in Tab 3.

### 4.3 Prototype tests

**4.3.1** Prototype tests are to be witnessed by a Surveyor from the Society and to include load test of the SAS equipment under a proof load at least equal to 2 times the safe working load defined in [2.1.6].

### 4.4 Tests on board

#### 4.4.1 General

The SAS arrangements are to undergo the following tests and inspections after their installation on board:

- static load test demonstrating the strength of the complete rigging of SAS equipment under a load condition larger than the operational one;
- after static load test, a visual inspection and functional test to demonstrate that the system is operational and has not suffered damages from the static load tests;
- overload tests to demonstrate proper functioning of the equipment on overload.

These tests are to be carried out according to a test programme submitted to the Society.

Testing and marking of the SAS equipment is to be in accordance with the relevant requirements of NR526 Rules for Lifting Appliances, Sec 10.

#### 4.4.2 Static load tests

Static load tests are to be performed using dedicated test wire rope, different from the ship wire rope used onboard.

The test loads are to be greater than twice the rated SWL of the rigging to be tested. In addition, for tensioned spanwire or highline systems, the test load is not to be less than 20% of the breaking strength of the spanwire or highline.

#### 4.4.3 Overload tests

Repeated load cycles specific to each type of equipment are to be performed according to a test programme submitted to the Society. As a rule, the test load is to be 1,5 times the rated operating load corresponding to the SWL.

On winches with adjustable clutches, the clutch need temporary readjustment in order to perform the overload tests. After completion of the test, the clutch or limiting devices are to be readjusted to the normal value and retested.

Table 3 : Materials and equipment certification

Item	Material certification	Product certification				Remarks	
		Design assessment Index	Examinations and tests				Certification
			During fabrication	After completion	Running tests		
Lifting appliances: masts, cranes, derricks	C (1)	DA	X (2)	X (2)	X (3)	C	(1) As per NR216 (2) As per relevant provisions of NR526 (3) Shop tests and running tests onboard as per [4.4]
Winches, anti-slack devices, Ram tensioner	C (1)	TA (2)	X	X	X (3)	C	(1) As per NR216 (2) As a rule, no individual design assessment of winches and RAS equipment (3) Onboard tests as per [4.4]
Electric motors and electrical equipment used for SAS operations (1)	W	DA or TA		X (2)	X (2)	W	(1) Considered as intended for secondary essential services (2) Testing of electric motors includes type tests and routine tests as per Pt C, Ch 2, Sec 4, [3]
Hydraulic cylinders, piping of class I and equipment essential for SAS operation (winches, Ram tensioner)	C		X s	X h		C	
Control systems of winches and essential systems for SAS operation (Ram tensioner)		DA			X (1)	C	(1) According to an agreed programme for onboard tests as per [4.4]
Cargo transfer hoses and pipes couplings, including breakaway couplings	C (1)	TA		X s h (2)	X (3)	C	(1) Only for metallic pieces and couplings (2) Non-destructive and hydraulic tests as per recognized standards or specification to be specified by the manufacturer (3) Emergency breakaway capabilities to be demonstrated onboard
Loose gear and accessories, including blocks, hooks, shackles, swivels ...	W	DA (1)		X (2)		C	(1) Only for elements not complying with a national or international standard (2) Proof load as per [4.3]
Steel wire ropes	W			X (1)		C	(1) As per requirement of NR216 or in compliance with a national or international standard (ISO 3178 for instance)

**Note 1:**  
 "C" indicates that a product certificate of the Society is required with invitation of the Society surveyor to attend the tests unless otherwise agreed.  
 "W" indicates that a manufacturer's certificate is required.  
 index "h" means that an hydraulic pressure test is required.  
 index "s" means that non destructive tests are required, as per Rules, standard or specification.  
 "TA" means a type approval is required.

**Note 2:** Where nothing is mentioned in the design index assessment column, a design assessment of the specific unit is not required.

## SECTION 19

## PERMANENT MEANS OF ACCESS (ACCESS)

### 1 General

#### 1.1 Application

**1.1.1** The additional class notation **ACCESS** is assigned in accordance with Pt A, Ch 1, Sec 2, [6.14.29] to ships defined in [1.1.2] for which permanent means of access comply with the requirements of:

- Regulation II-1/3-6 of SOLAS as amended - Access to and within spaces in, and forward of, the cargo area of oil tankers and bulk carriers
- IMO Resolution MSC.133(76) - Adoption of technical provisions for means of access for inspections
- IMO Resolution MSC.158(78) - Adoption of amendments to the technical provisions for means of access for inspections
- IACS UI SC 191, latest revision - Unified Interpretation for the application of amended SOLAS regulation II-1/3-6 (resolution MSC.151(78)) and revised Technical provisions for means of access for inspections (resolution MSC.158(78)).

**1.1.2** The ships to which additional class notation **ACCESS** may be assigned are:

- oil tankers of 500 gross tonnage and over, having integral tanks for carriage of oil in bulk, which is contained in the definition of oil in Annex 1 of MARPOL 73/78 as amended
- bulk carriers (as defined in regulation IX/1 of SOLAS as amended) of 20000 gross tonnage and over.

**1.1.3** The alternative, movable or portable means of access are outside the scope of the additional class notation **ACCESS**.

#### 1.2 Definitions

##### 1.2.1 Permanent Means of Access

They are permanent means of access provided to enable, throughout the life of a ship, overall and close-up inspections and thickness measurements of the ship's structures to be carried out by the Administration, the Society, the Owner and the ship's personnel and others as necessary.

## SECTION 20

## HELIDECK (HEL)

### 1 General

#### 1.1 Application

**1.1.1** The additional class notation **HEL** is assigned, in accordance with Pt A, Ch 1, Sec 2, [6.14.22], to ships fitted with helicopter facilities and complying with [1.2.1], in addition to the requirements from Part B and Part C, as applicable to helicopter facilities.

#### 1.2 Reference standard

**1.2.1** The design and arrangement of the helicopter facilities are to be in accordance with the Civil Aviation Publication 437 "Offshore Helicopter Landing Areas - Guidance on Standards" (CAP 437)".

The following chapters of CAP 437 are applicable, except where it refers to operational procedures or training, and where applicable for design and safety equipment on the unit:

- Chapter 3 Helicopter landing areas – Physical characteristics
- Chapter 4 Visual aids
- Chapter 5 Helideck rescue and fire fighting facilities
- Chapter 7 Helicopter fuelling facilities – Systems design and construction
- Chapter 9 Helicopter landing areas on vessels
- Chapter 10 Helicopter winching areas on vessels and on wind turbine platforms.

## SECTION 21

## BATTERY SYSTEM

### 1 General

#### 1.1 Application

**1.1.1** The additional class notation **BATTERY SYSTEM** may be assigned to ships when batteries are used for propulsion and/or electric power supply purpose during ship operation. This notation is mandatory when the ship is relying only on batteries for propulsion and/or electrical power supply for main sources.

**1.1.2** When an emergency source of power is required on board the ship, it is to remain independent from the battery source considered for propulsion and/or main source of power.

**1.1.3** Batteries may be of the lead-acid type, nickel alkaline type or lithium type, due consideration being given to the suitability for any specific application. Other types of batteries may be considered (see [3.2.5]).

**1.1.4** These requirements are supplementary to those mentioned in Pt C, Ch 2, Sec 7, Pt C, Ch 2, Sec 12, [5] and Pt C, Ch 4, Sec 12.

#### 1.2 Documents to be submitted

**1.2.1** The documents to be submitted are listed in Tab 1.

### 2 Definitions and acronyms

#### 2.1 System considered

**2.1.1** The system considered is summarised in Fig 1.

#### 2.2 Definitions

##### 2.2.1 Battery management system (BMS)

A battery management system is an electronic system associated with a battery pack which monitors and/or manages in a safe manner its electric and thermal state by controlling its environment, and which provides communication between the battery system and other macro-system controllers, such as a power management system (PMS).

##### 2.2.2 Battery pack

Battery pack means one or more sub-packs that can work or the intended purpose as a standalone unit.

##### 2.2.3 Battery support system (BSS)

A battery support system is a group of interconnected and interactive parts that performs an essential task as a component of a battery system.

Note 1: Such systems are, for example, electrolyte circulation pumps, cooling and heating devices or fire extinguishers.

##### 2.2.4 Battery system

A battery system is an energy storage device that includes cells, cell assemblies or battery pack(s), as well as electrical circuits and electronics (example of electronics: BMS, BSS, cell electronics).

##### 2.2.5 Cell

Cell means the smallest unit of a battery.

##### 2.2.6 Cell electronics

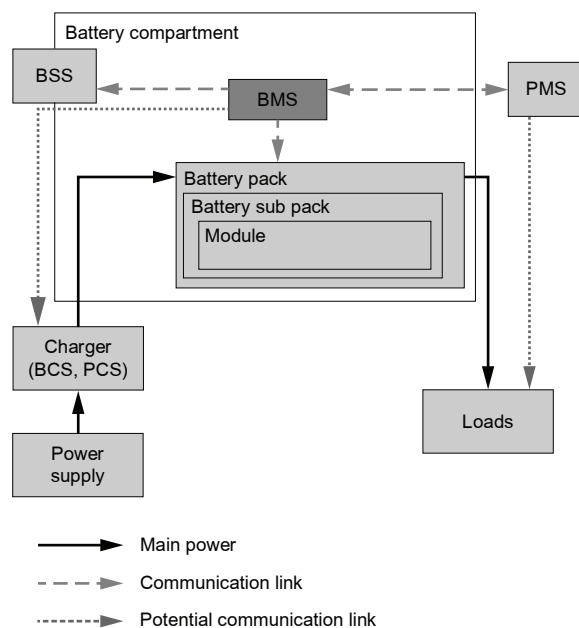
Cell electronics means the electronic device that collects and possibly monitors thermal and electric data of cells or cell assemblies and contains electronics for cell balancing, if necessary, as well as over-current protection devices (e.g. fuse).

Note 1: The cell electronics may include a cell controller. The functionality of cell balancing may be managed by the cell controller as part of a modular BMS.

##### 2.2.7 Module

A module is an assembly of cells including some levels of electronic control.

**Figure 1 : Battery system considered**



This configuration shows only one battery pack. The battery pack may be duplicated inside the battery system.

BCS : Battery charging system  
 BSS : Battery support system  
 PCS : Power conversion system  
 PMS : Power management system  
 BMS : Battery management system.

**Table 1 : Documents to be submitted**

No.	A/I (1)	Document	Document details
1	A	Power balance	This document is to take into account the achievable configurations for energy production and distribution
2	A	Risk analysis when required (see [3.2.5])	This document is to consider together battery and BMS if any
3	A	Failure analysis regarding availability of ship propulsion and energy	
4	I	Information about toxic products present or likely to be produced in the battery system	
5	A	List of alarms and defaults	This list is to describe alarms and defaults directly connected to the battery system and interfaces with other ship systems, if any
6	A	Justification for choice of fire-extinguishing system	
7	I	Operation manual of battery and BMS	
8	A	Test programs related to type approval, factory test and onboard tests	
9	I	Reports related to test programs for type approval, gas analysis, factory test and onboard tests	
10	I	Standards used for design and testing procedures	If such standard is not available, the Manufacturer's specification is to be submitted
(1) A = to be submitted for approval I = to be submitted for information.			

### 2.2.8 Rated capacity

Rated capacity means Supplier's specification of the total amount of ampere hours that can be withdrawn from a fully charged battery pack or system for a specified set of test conditions, such as discharge rate, temperature and discharge cut-off voltage.

### 2.2.9 State of charge (SOC)

State of charge means the available capacity in a battery pack or system, used to estimate the current charge level of a battery in use.

### 2.2.10 State of health (SOH)

State of health means the available capacity in a battery pack or system as a function of the battery lifetime.

Note 1: SOC and SOH are expressed as percentages of rated capacity.

### 2.2.11 Sub-pack

Sub-pack means the assembly of one or more modules. This is the smallest unit that can be electrically isolated.

## 3 Safety and design issues

### 3.1 Battery compartment

#### 3.1.1 Ventilation

In general, requirements mentioned in Pt C, Ch 2, Sec 11, [6] for large vented batteries are to be referred to. For lithium-ion batteries, requirements mentioned in Pt C, Ch 2, Sec 11, [6] for valve-regulated sealed batteries apply.

Additionally, when hazardous areas may be created regarding criteria of IEC 60079 series, the battery compartment and its neighbourhood is to be considered accordingly. In

this case, a specific detection should be implemented, in order to monitor:

- negative pressure of the room
- ventilation air flow
- explosive or inflammable gas concentration. Detectors are to be positioned regarding air streams repartition in the battery compartment
- position of ventilation circuit valves.

When toxic products may be emitted in normal or abnormal conditions of operation, a specific analysis is to be undertaken (see [3.2.5]).

Note 1: The risk of release of toxic or explosive gases is to be assessed based on the gas analysis performed during the battery pack prototype testing, as required by [5.3.5].

#### 3.1.2 Protection against water entry and/or liquid leakage in battery compartment

It should not be possible to have sea water entering battery compartment under normal operating conditions.

The piping systems not involved in battery operation are not to be located in the battery compartment. Departure from this requirement may be accepted by the Society, with the following minimum conditions:

- efficient detection of fluid leakage is implemented in compartment
- pipes are provided with welded joints inside the battery compartment
- no flammable fluid is conveyed
- only class III pipes are accepted.

#### 3.1.3 Protection against falling objects

Access hatches to batteries are to prevent falling of objects directly on battery cells, connections, elements of BMS, and cooling system if any.

### 3.1.4 Protection against electrostatic hazard

When hazardous areas may be created regarding criteria of IEC 60079 series, the battery room is to be painted with antistatic paintings in the circulating area.

Battery rooms containing Lithium batteries need not be painted with antistatic paintings, provided it is confirmed by the risk analysis required in [3.2.4].

### 3.1.5 Fire protection

a) For the purpose of Part C, Chapter 4, battery rooms are to be regarded as:

- auxiliary machinery spaces of moderate fire risk i.e. cat(11) on passenger ships carrying more than 36 passengers
- other machinery spaces i.e. cat(7) on other ships

The boundary between two battery rooms is to have at least A-0 fire integrity.

In addition, the safety measures detailed in item b) to item d) are to be applied.

- b) The boundaries between battery rooms containing Lithium-type batteries and machinery spaces of category A are to have A-60 fire integrity. The boundaries between battery rooms containing Lithium-type batteries and other rooms are to have the fire integrity required between a machinery space of category A and that other room.
- c) A fixed fire detection system complying with the requirements of Pt C, Ch 4, Sec 15, [8] is to be provided in battery rooms. Combined heat and smoke detection is to be installed in battery rooms for Lithium-type batteries.
- d) Battery rooms are to be fitted with a fixed fire-extinguishing system according to Pt C, Ch 4, Sec 6, [3.1]. This system is to be compatible with the technology of the battery employed, according to the battery manufacturer specification.

### 3.1.6 Accessibility for maintenance

It is to be possible to enter the battery compartment for common maintenance and to overhaul battery system elements in a safe manner.

## 3.2 Battery pack

### 3.2.1 Battery pack cooling

Battery pack cooling is to be ensured either by the ventilation of the battery compartment or by direct cooling (dedicated cooling circuit).

When a direct cooling is installed, the following alarms are to be provided, where applicable:

- High temperature of the cooling air of battery pack provided with forced ventilation (see Note 1)
- Reduced flow of primary and secondary coolants of Battery packs having a closed cooling system with a heat exchanger (see Note 1).

Note 1: As an alternative to the air temperature and to the cooling flow, the supply of electrical energy to the ventilator may be monitored.

### 3.2.2 Protection against ingress

IP rating of the batteries is to be fitted in relation with the location of the installation and the risk of ingress. The minimum required degree of protection is as follows:

- IP 2X for battery packs less than 1500 V DC
- IP 32 for battery packs more than 1500 V DC.

### 3.2.3 Lead-acid batteries, Ni-Cd batteries

The requirements mentioned in Pt C, Ch 2, Sec 7 apply for these type of batteries.

### 3.2.4 Lithium batteries

When lithium batteries are fitted, a risk analysis as mentioned in [3.2.5] is to be provided.

Lithium battery pack charging and un-charging are to be controlled with a BMS that is to be able:

- to monitor the battery pack state at the level at least of modules, sub-packs and packs regarding at least voltage, temperature, and, if necessary, to monitor current flow and detect leakage currents
- to estimate the potential need for battery pack or sub-pack connection or disconnection by determining if the battery pack or sub-pack is in a critical state, if there is a need coming from the PMS system or any other connected control system
- to control the proper connection and disconnection of the battery packs and sub-packs
- to optimise battery lifetime and energy availability by monitoring and controlling battery pack SOC and SOH, managing cells, sub-packs and packs balancing, and monitoring and controlling BSS.

### 3.2.5 Other types of batteries and risk analysis

Other types of batteries may be accepted by the Society. As for the lithium type batteries, a risk analysis covering together battery packs, battery compartment and BMS is to be conducted and submitted to the Society for review.

The following items, at least, are to be covered:

- risk of thermal runaway
- risk of emission of combustion gases
- risk of internal short-circuit
- risk of external short-circuit
- risk of sensor failure (voltage, temperature, gas sensor...)
- risk of high impedance (cell, connectors, ...)
- risk of loss of cooling
- risk of leakage (electrolyte, cooling system)
- risk of failure of BMS (error on manoeuvring breakers, overloading, over discharge ...)
- risk for external ingress (fire, fluid leakage, fire-fighting water...).

Adequation of fire-extinguishing system to battery type should be documented.

Appropriate alarms and shutdown should be described (for example, default on the cooling system when necessary to proper operation of the battery system).

## 4 Availability of power

### 4.1 Ship configuration

4.1.1 The following cases are to be considered:

- Case 1: global battery system failure leads to loss of propulsion or of main electrical sources, see [4.2]
- Case 2: global battery system failure does not lead to any loss regarding ship propulsion and main source of power, see [4.3].

### 4.2 Case 1: global battery system failure leads to loss of propulsion or of main electrical sources

#### 4.2.1 Types of ships

The ships falling onto SOLAS Convention cannot, from the Society point of view, be allowed to have configuration as mentioned in case 1.

#### 4.2.2 Minimum requirements

The battery system is to be fitted with at least two independent packs of batteries to supply the main energy source.

A failure analysis taking into account single failure of the battery system and ability of the ship to reach a safe destination or to operate life-saving appliances and safety systems is to be provided.

If passengers, or cargoes falling onto consideration of MARPOL Convention, are transported, it is to be possible to steer and manoeuvre the ship with one battery pack unavailable.

### 4.3 Case 2: global battery system failure does not lead to any loss regarding ship propulsion and main source of power

#### 4.3.1 Types of ships

It is reminded that flag agreement needs to be obtained for statutory compliance, especially regarding method to obtain compliance with SOLAS Convention.

In case where a ship is not complying with SOLAS Convention when the battery system is not taken into account, requirements [4.3.2] and [4.3.3] are to be considered.

#### 4.3.2 Minimum requirements

The requirements mentioned in [4.2.2] are to be complied with.

#### 4.3.3 Additional requirements for compliance to SOLAS Convention from the Society point of view

When the battery pack is supposed to replace the main energy source and the propulsion energy source, it is to be able to provide energy for 8-hour operations, as mentioned in Pt C, Ch 1, Sec 10, [11].

## 5 Test and certification process for batteries

### 5.1 Battery cells

#### 5.1.1 Scheme of approval

Battery cells are to be type approved according to scheme H<sub>BV</sub> as described in NR320, Certification Scheme of Materials and Equipment for the Classification of Marine Units. See Tab 2.

#### 5.1.2 General

Battery cells are to be constructed and tested in accordance with the relevant IEC Publications 62619 and 62281.

Battery cells constructed and tested in accordance with other standards may be accepted, provided they are in accordance with an acceptable and relevant international or national standard and are of an equivalent or higher safety level, to the satisfaction of the Society.

#### 5.1.3 Prototype tests

The following items, at least, are to be checked:

- External short circuit
- Impact / Crush
- Drop
- Thermal abuse / Thermal cycling
- Overcharge
- Forced discharge
- Internal short circuit
- Insulation tests (High voltage test and insulation resistance test according to Pt C, Ch 2, Sec 8, [3])

#### 5.1.4 Factory acceptance tests

The following items, at least, are to be checked:

- Insulation tests (High voltage test and insulation resistance test according to Pt C, Ch 2, Sec 8, [3])

#### 5.1.5 Onboard test

Battery cell test in itself is to be included in the battery pack test.

### 5.2 Equipment used in battery systems

5.2.1 Approval and testing of pieces of equipment, such as safety electrical equipment, fuses, over current protective devices, circuit breakers, contractors and cables, are to follow the requirements mentioned in Part C, Chapter 2 and NR266, Requirements for Survey of Materials and Equipment for the Classification of Ships and Offshore Units.

### 5.3 Battery packs and associated BMS

#### 5.3.1 Scheme of approval

Battery packs are to be type approved according to scheme I<sub>BV</sub> as described in NR320 (see Tab 2). When a battery pack is installed with a BMS, the type approval is to cover battery pack and BMS. A case-by-case approval can be applied with the same review and testing as for the type approval scheme.



Table 2 : Schemes of approval

Item	Product certification				Remarks
	Design assessment/ Approval (1)	Raw material certificate	Examination and testing	Product certificate (2)	
Battery Cell	TA (H <sub>BV</sub> )		X (see [5.1])	W	
Battery pack and associated BMS	TA (I <sub>BV</sub> )		X (see [5.3])	C	
<p>(1) TA (H<sub>BV</sub>) : Type Approval is required with work's recognition (H<sub>BV</sub> scheme as per NR320)  TA (I<sub>BV</sub>) : Type Approval is required with work's recognition (I<sub>BV</sub> scheme as per NR320).  (2) W indicates that a Manufacturer's certificate is required.  C indicates that a product certificate of the Society is required with invitation of the Surveyor to attend the tests, unless otherwise agreed.</p>					

### 5.3.2 General

Battery pack are to be constructed and tested in accordance with the relevant IEC Publications 62619 and 62620.

Battery pack constructed and tested in accordance with other standards may be accepted, provided they are in accordance with an acceptable and relevant international or national standard and are of an equivalent or higher safety level, to the satisfaction of the Society.

### 5.3.3 Prototype tests

The following items, at least, are to be checked:

- a) Propagation/internal thermal event
- b) Overcharge control of voltage
- c) Overcharge control of current
- d) Overheating control
- e) Insulation tests (High voltage test and insulation resistance test according to Pt C, Ch 2, Sec 8, [3])
- f) IP characteristics
- g) Safety function tests :
  - Emergency stop function
  - Alarms and shutdowns
  - Temperature protection BMS
  - Overvoltage protection BMS
  - Undervoltage protection BMS
  - Communication Failure
- h) Discharge performance (rated capacity check)
- i) Endurance
- j) Charge retention and recovery (self discharge)
- k) Additional tests based on FMEA (sensors failures,...)
- l) Environmental tests according to Pt C, Ch 3, Sec 6.

### 5.3.4 Gas analysis

The types and quantities of gases released by the cell when submitted to the propagation/internal test required in [5.3.3], item a) are to be measured and recorded. This gas analysis will be used as an input for the risk analysis required in [3.2.4] and the design of the battery compartment, see [3.1].

### 5.3.5 Factory acceptance tests

The following items, at least, are to be checked:

- ability to achieve safety functions
- proper working of alarms and defaults and related functions and/or interfacing to the other ship systems
- proper working of monitoring systems
- when direct cooling is provided, temperature rise test in order to check the proper working of the cooling circuit (see [3.2.1])

Note 1: The test condition to be selected is the most unfavourable nominal operating conditions of the batteries (maximum charging or discharging current which will produce the maximum heating losses)

- Insulation tests (High voltage test and insulation resistance test according to Pt C, Ch 2, Sec 8, [3])
- IP characteristics.

Note 2: When this test is impractical at the factory, the following alternative may be considered:

- a calculation based on a method validated by tests is to be submitted to the Society, and
- Proper working of the cooling circuit is to be checked after installation onboard, see [5.3.6].

### 5.3.6 Onboard tests

The following items, at least, are to be checked:

- proper working of alarms and defaults and related functions and/or interfacing to the other ship systems
- proper working of monitoring systems
- fitting of battery pack arrangement to battery compartment
- battery capacity and loading duration, at least for the cases mentioned in the ship availability failure analysis
- Insulation resistance test
- IP characteristics.
- Temperature rise test in order to check the proper working of the cooling circuit, when direct cooling is provided and when the cooling test has not been performed during factory acceptance tests, see [5.3.5], Note 2.

## **5.4 Onboard tests of battery compartment and fire-extinguishing system**

### **5.4.1 Fire detection**

Efficiency of fire detection is to be tested.

### **5.4.2 Dangerous gas detection**

Efficiency of dangerous gas detection is to be tested. This includes testing that detectors were properly positioned to detect dangerous gas concentration in any normal circumstance of operation of the ventilation system.

### **5.4.3 Fire-extinguishing system efficiency**

Efficiency of fire-extinguishing system is to be tested. Gas concentration after fire-extinguishing system operation is to be measured and found high enough to prevent an explosion or stop a fire. Other criteria may be defined or asked for, at the satisfaction of the Society.

### **5.4.4 Accessibility of battery compartment**

Accessibility for common maintenance and devices used for battery overhaul, if any, are to be tested.

## SECTION 22

## ELECTRIC HYBRID

### 1 General

#### 1.1 Application

**1.1.1** The additional class notation **ELECTRIC HYBRID** may be assigned in accordance with Pt A, Ch 1, Sec 2, [6.14.40] to ships provided with an Energy Storage System (ESS) used to supply the electric propulsion and/or the main electrical power distribution system of the ship.

The notation **ELECTRIC HYBRID** is to be completed, between brackets, by at least one of the following complementary notations:

- **PM** when at least one of the following Power Management mode is available:
  - load smoothing mode
  - peak shaving mode
  - enhanced dynamic mode,
 as defined in [1.3.3].
- **PB** when Power Backup mode, as defined in [1.3.4], is available.
- **ZE** when Zero Emission mode, as defined in [1.3.5], is available.

Examples of notations are given below:

**ELECTRIC HYBRID (PB)**

**ELECTRIC HYBRID (PM, ZE)**

**1.1.2** The ESS aims to assist the electric propulsion and/or the main electrical distribution system with the power demand, and/or to take over from the main source of electrical power.

**1.1.3** The notation **ELECTRIC HYBRID** applies to the following cases, as illustrated in Fig 1:

- the ESS supplies the main switchboard, or
- the ESS supplies a propulsion switchboard, or
- the ESS supplies both the main switchboard and a propulsion switchboard.

#### 1.2 Documents to be submitted

**1.2.1** The documents to be submitted are listed in Tab 1.

#### 1.3 Definitions

##### 1.3.1 Electric Energy Storage System (ESS)

The ESS is a system based on battery packs, semiconductor converter (if any) and transformer (if any). It is used to supply the electric propulsion and/or the main electrical power distribution system of the ship.

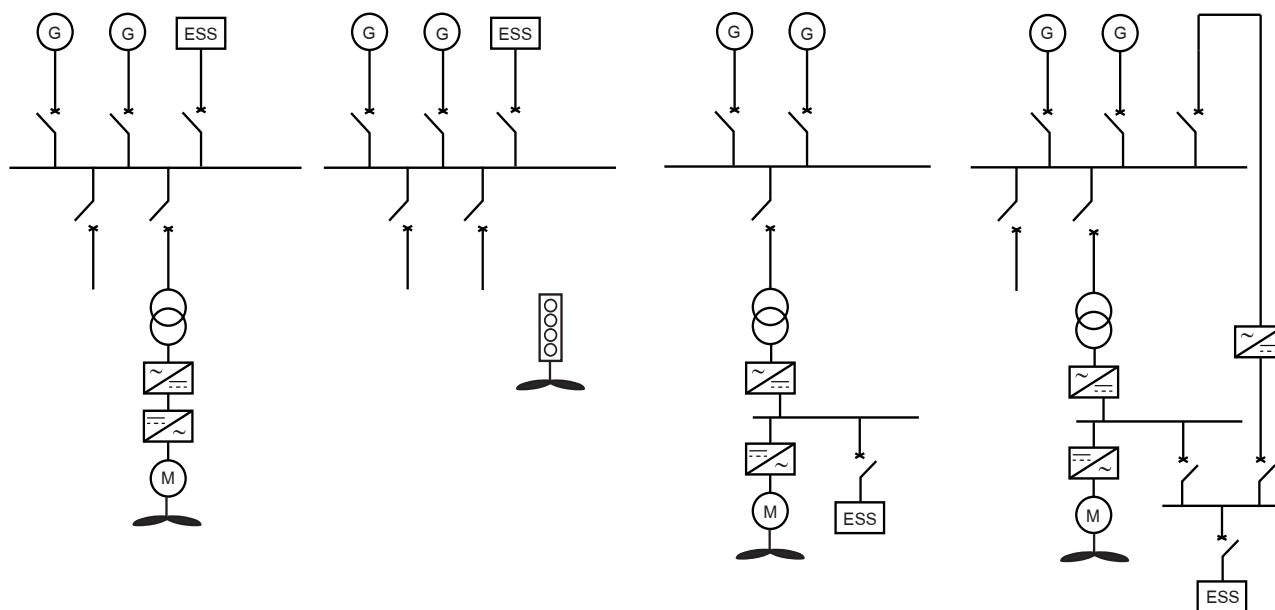
The ESS may be based on the following configurations (see Fig 2):

- direct supply (DC switchboard), or
- supply through a DC/DC semiconductor converter (DC switchboard), or
- supply through an DC/AC semiconductor converter and/or a transformer (AC switchboard).

**Table 1 : Documents to be submitted**

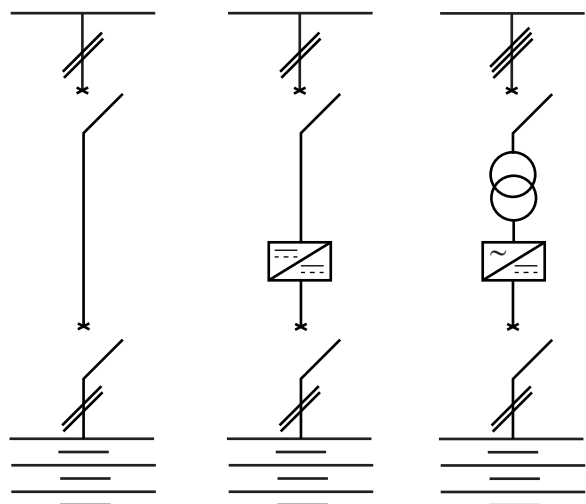
No.	I / A (1)	Documents
1	I	General description of the ESS and the different operating modes
2	I	Power balance, see (2)
3	A	Failure Mode and Effect Analysis (FMEA) regarding the availability of ship propulsion and main electrical source of power
4	A	List of alarms and defaults. This list is to describe alarms and defaults directly connected to the battery system and interfaces with other ship systems
5	I	Operation manual of ESS
6	A	Test programs related to type approval, factory test and onboard tests including the standards used for design and testing procedures
7	I	Reports related to test programs for type approval, factory test and onboard tests
8	I	Maintenance manual and maintenance schedule
9	I	For ZE Mode: Electrical load balance and specified design autonomy period, see [3.5.3]
10	I	For PB Mode: Electrical load balance(s) for power back up, see [3.5.2]
<p>(1) I = to be submitted for information. A = to be submitted for approval.</p> <p>(2) The load balance is to include the battery charging phase. See [2.2.10].</p>		

Figure 1 : Typical ESS supply arrangements



The examples given in Fig 1 are for an AC network. The same principles apply to a DC network.

Figure 2 : ESS possible configurations



**1.3.2 Energy Control System (ECS)**

The energy control system ensures the overall control and monitoring of the ESS: battery, converter, transformer and circuit breaker.

**1.3.3 Power Management mode (PM mode)**

For the purpose of this Section, the term PM mode is used for one of the following power management mode (see Fig 3):

a) Load smoothing mode:

Load smoothing mode is a mode where the ESS is charged and discharged all the time to compensate for the network load variations within a given amplitude above or below the average.

This will result in limited load fluctuations of the main generating sets, allowing optimised fuel consumptions and reduced exhaust gas emissions

Note 1: This mode is also named load optimising mode.

b) Peak shaving mode:

Peak shaving mode is a mode dedicated to instant power demand. The goal is to supply peaks of a highly variable load (e.g. during manoeuvring) and to avoid the connection of an additional main generating set.

c) Enhanced dynamic mode:

Enhanced dynamic mode is mainly related to gas fuel or dual fuel generating sets. In case of sudden load increase, the ESS instantaneously supplies the corresponding power demand, thus enhancing the generator dynamic performance, and, for dual fuel engines, preventing the possible switch-over to fuel oil due to ramping-up.

**1.3.4 Power Back up mode (PB mode)**

The PB mode is a mode where the ESS is permanently connected to the main electrical power distribution system of the ship and is able to deliver power immediately in case of failure of one main generating set.

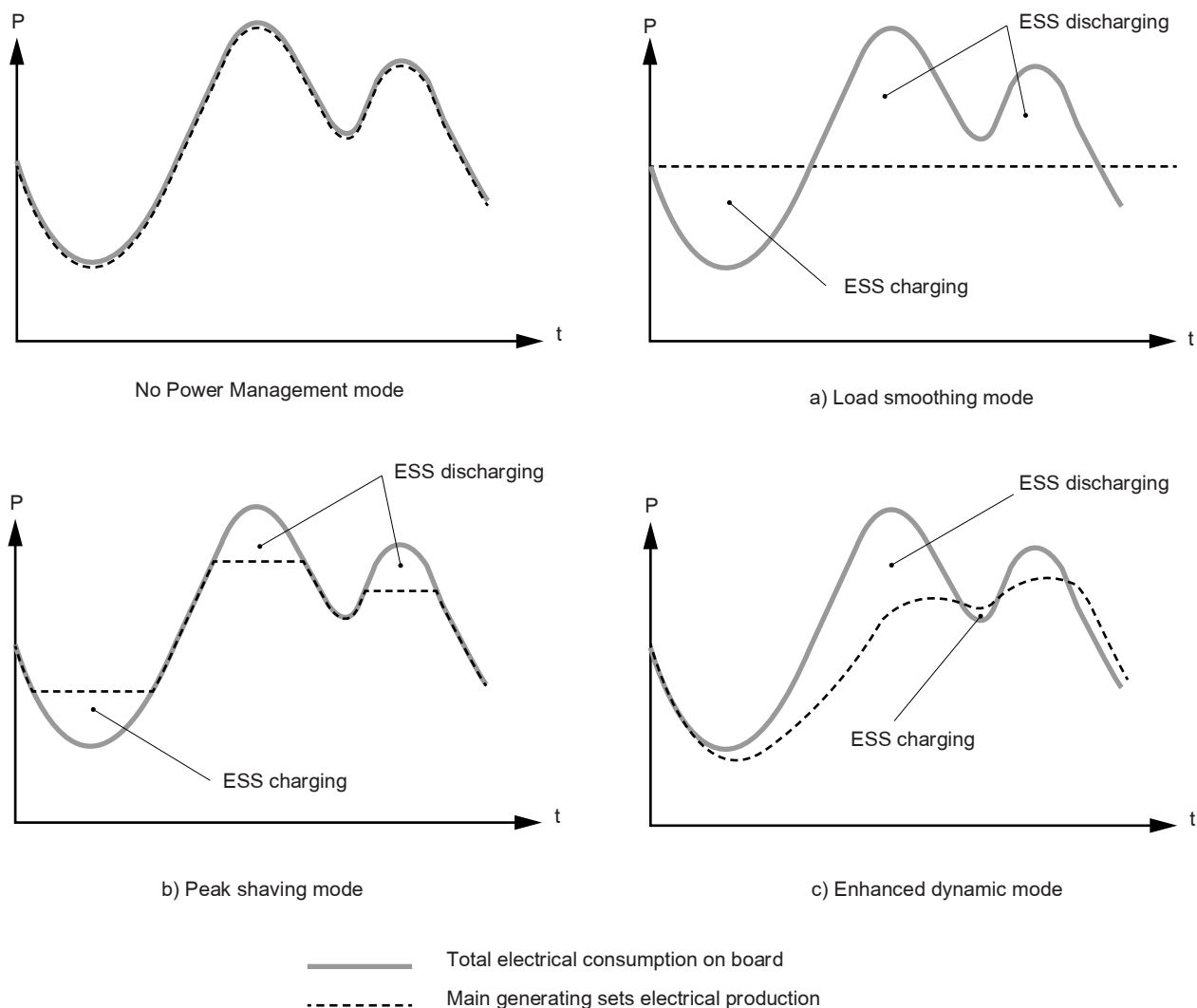
Note 1: This mode is also named spinning reserve mode.

**1.3.5 Zero Emission mode (ZE mode)**

The ZE mode is a mode where the ESS is temporarily the only source of power connected to electrical network. This mode allows stopping all the main generator sets, the main diesel engines, boilers and incinerators, if any, and the associated emission of exhaust gas for a specified period of time (manoeuvring, ship at berth).

Note 1: The ZE mode, unlike the PB mode, is activated on a voluntary basis.

Figure 3 : Power Management modes (PM)



## 2 System design

### 2.1 Quality of power supply

**2.1.1** Characteristics of power supply at the main switchboard or at the propulsion switchboard may be outside the limits defined in Pt C, Ch 2, Sec 2, [2] (e.g. due to battery voltage drop), provided it is compensated for through the semiconductor converters supplying the essential services. Alternatively, the electrical devices are to be designed to operate outside of these limits and justifications are to be transmitted by the manufacturers to the Society.

### 2.2 Power distribution

**2.2.1** The ESS is not considered as forming part of the main source of electrical power, as defined in Pt C, Ch 2, Sec 3, [2.2].

**2.2.2** The ESS is to remain independent of the emergency source or transitional source of power, if any, required in Pt C, Ch 2, Sec 3, [2.3].

**2.2.3** For PM mode, where generators can be paralleled, a Power Management System (PMS) is to be provided. The system is to include automatic start, synchronising, connecting and load sharing.

Where the number of generators in service is to vary according to operating condition, starting and connecting of supplementary generators, entailed by the use of equipment during manoeuvring, is not to require intervention in machinery spaces.

**2.2.4** For PB mode, the ESS is to be able to maintain without a break the continuity of the power supply, in case of failure of one main generating set.

**2.2.5** A Failure Mode and Effects Analysis (FMEA) is to be carried out in accordance with IEC Publication 60812 or any other recognised standard in order to demonstrate the availability of ship propulsion and main electrical source of power in case of failure of the ESS.

**2.2.6** The ESS may be used in addition to the emergency source or transitional source to supply services other than those listed in Pt C, Ch 2, Sec 3, [3.6].

**2.2.7** The ESS is to be able to be charged either by the ship electrical network, or at quay through a shore supply.

**2.2.8** In all operating modes, the electrical protection selectivity of the distribution system is to be ensured.

**2.2.9** The short circuit current calculation is to take into account the ESS. In calculating the maximum prospective short-circuit current, the source of current is to include the most powerful configuration of generators which can be simultaneously connected (as far as permitted by any interlocking arrangements), and the maximum number of motors which are normally simultaneously connected in the system.

#### **2.2.10 PB mode and ZE mode**

An electrical load balance corresponding to battery charging mode is to be submitted for information.

The maximum battery charging current is to be taken into account.

### **3 Electric Energy Storage System (ESS)**

#### **3.1 ESS battery pack**

**3.1.1** The battery pack is to be in accordance with Ch 11, Sec 21, [3.2].

#### **3.2 ESS semiconductor converter**

**3.2.1** The ESS semiconductor converter, if any, is to be in accordance with Pt C, Ch 2, Sec 6.

The semiconductor converters may be rated for intermittent power demand. The rating is to be determined on the basis of the operating profile of the ship.

#### **3.3 ESS transformer**

**3.3.1** The ESS transformer, if any, is to be in accordance with Pt C, Ch 2, Sec 5.

The transformer may be rated for intermittent power demand. The rating is to be determined on the basis of the operating profile of the ship.

#### **3.4 Energy Control System (ECS)**

**3.4.1** The ECS is to be independent of:

- the Battery Management System (BMS), and
- the Power Management System (PMS)

**3.4.2** The electronic components of the ECS are to be constructed to withstand the tests required in Pt C, Ch 3, Sec 6.

#### **3.5 ESS capacity**

##### **3.5.1 PM mode**

In power management mode, the capacity of the ESS is to be such that it covers the operating profile of the ship in normal operation during 24 hours, including at least one manoeuvring cycle, without reaching the ESS state of charge low level.

##### **3.5.2 PB mode**

An electrical load balance corresponding to power backup mode is to be submitted for information. Load shedding of non-essential services and services for habitability may be considered for definition of this load balance.

The capacity of the ESS for PB mode is to be sufficient to supply, in this condition, the main switchboard during at least twice the time necessary to start a stand-by source (see Pt C, Ch 2, Sec 3, [2.2.7] or Pt C, Ch 2, Sec 3, [2.2.8], as applicable).

##### **3.5.3 ZE mode**

An electrical load balance corresponding to zero emission mode is to be submitted for information.

The capacity of the ESS is to be such that ZE mode can be maintained in this condition during a design autonomy period specified by the designer and at least twice the time necessary to start a stand-by source (see Pt C, Ch 2, Sec 3, [2.2.7] or Pt C, Ch 2, Sec 3, [2.2.8], as applicable).

#### **3.6 ESS charging**

**3.6.1** After partial or full discharge, the charging current of the batteries will be limited due to the high temperature of the battery cells.

Therefore, in PB and ZE mode, the charging current and the time to charge completely the batteries is to be evaluated during a charging test, just after the ESS has been discharged in the conditions of load balance for PB or ZE mode, as defined in [3.5.2] and [3.5.3] respectively.

#### **3.7 ESS control and instrumentation**

**3.7.1** The ESS is to be easily disconnectable from the main machinery control room. Further to this operation, starting of a stand-by source, if necessary, is to be automatic.

**3.7.2** The following information is to be permanently displayed at the main machinery control room:

- Active operating mode (Load smoothing mode, Peak shaving mode, Enhanced dynamic mode, Power back up mode, Zero emission mode)
- Charging/Discharging status of the ESS
- State of charge of the ESS
- Remaining autonomy for ZE mode and PB mode
- State of health of the ESS
- Values of the current/voltage of the ESS
- Values of the current/voltage at the battery pack
- Active power delivered.

**3.7.3** ESS parameters are to be monitored or controlled according to Tab 2.

Table 2 : Energy storage system

Symbol convention H = High, G = group alarm L = Low, LL = Low low, I = individual alarm X = function is required,	Monitoring	Automatic control		
		Energy storage system	Main generating set	Propulsion motor
Identification of system parameter	Alarm	Shut-down	Standby Start	Slow-down
Short-circuit current I max	I	X	X (1)	
Overload	I	X	X (1)	
Overvoltage	I	X	X (1)	
Undervoltage	I	X	X (1)	
State of charge	L		X (1)	X (1)
	LL			
Converter (2) air cooling temperature	H			
Transformer (2) air cooling temperature	H			
Converter (2) ventilation fan failure	G			
Transformer (2) ventilation fan failure	G			
(1) Applicable only for ZE mode and PB mode.				
(2) If any.				

### 3.7.4 Additional control and instrumentation for ZE mode and PB mode

- The ESS state of charge low level alarm is to correspond to, at least, the minimum state of charge allowing the time necessary to start a stand-by main generating set.  
This alarm is to be indicated on the navigation bridge.
- The ESS state of charge low level alarm is to correspond to an imminent stop of the ESS.  
This alarm is to be indicated on the navigation bridge.
- Automatic starting and connecting to the main switchboard of stand-by generator(s) of sufficient capacity with automatic restarting of the essential auxiliaries, in sequential operation if required, is to be carried out in the following cases:
  - Failure of the ESS
  - State of charge low level alarm of the ESS.

## 4 Installation on board

### 4.1 Safety and design of battery system

4.1.1 Battery installation is to be in accordance with Ch 11, Sec 21, [3].

## 5 Testing

### 5.1 Factory acceptance tests

5.1.1 Each individual component is to be tested separately:

- ESS battery pack, see Ch 11, Sec 21, [5]
- ESS semiconductor converter, see Pt C, Ch 2, Sec 6, [3]
- ESS transformer, see Pt C, Ch 2, Sec 5, [2].

## 5.2 Onboard tests

5.2.1 The following items, at least, are to be checked:

- proper working of monitoring systems
- proper working of alarms and defaults and related functions and/or interfacing to the other ship systems
- quality of the power supply in the different modes (see Pt C, Ch 2, Sec 4, [2.2.5])
- disconnection of the ESS (see [3.7.1]) in different operating modes, and automatic start of a stand by source, if necessary

### 5.2.2 Tests to be carried out for PM mode

In power management mode, the following tests are at least to be carried out:

- Increasing load steps. The ESS is to deliver power to the grid, to compensate for the load steps. In case of continuous load, the load is to be gradually transferred to the running diesel engine. The load is to be shared equally between the diesel engines (see Pt C, Ch 2, Sec 4, [2.2.5]).
- Additional increasing load steps. The load dependant start of a stand by main generating set is to be activated.
- Checking of the operation if the ESS during 6 hours at least in normal working condition. The ESS state of charge is not to be less than 80% at the end of the 6 hours period.

A load analysis curve corresponding to this period is to be submitted for information. This document is to detail the total electrical production on board, the main generating sets electrical production and the ESS electrical production (with charging and discharging cycles).

### 5.2.3 Tests to be carried out for PB mode

In power backup mode, the following tests are at least to be carried out:

- failure of one generator and automatic connection of the ESS
- failure of one generator and ESS autonomy measurement (starting of the stand by generator is blocked).
- automatic start of a stand by source in case of failure of the ESS or low state of charge of the ESS
- charging test, see [3.6.1].

### 5.2.4 Tests to be carried out for ZE mode

In zero emission mode, the following tests are at least to be carried out:

- load discharge test with ESS autonomy measurement up to ESS state of charge low level,
- automatic start of a stand by source in case of failure of the ESS or low state of charge of the ESS.
- charging test, see [3.6.1].

## 5.3 Tests of battery compartment and fire-extinguishing system

5.3.1 Test defined in Ch 11, Sec 21, [5.4] are to be carried out.



## SECTION 23

## UNSHeltered ANCHORING

### 1 General

#### 1.1 Application

**1.1.1** The additional class notation **UNSHeltered ANCHORING** is assigned, in accordance with Pt A, Ch 1, Sec 2, [6.14.42], to ships fitted with anchoring equipment in deep and unsheltered water complying with the requirements of this Section, in addition to the requirements from Pt B, Ch 9, Sec 4, as applicable to equipment.

**1.1.2** The requirements of this Section apply to ships with an equipment length  $L_E$ , as defined in Pt B, Ch 9, Sec 4, [1.2.2], greater than 135 m and intended to anchor in deep and unsheltered water with:

- depth of water up to 120 m
- current speed up to 3 knots (1,54 m/s)
- wind speed up to 27 knots (14 m/s)
- waves with significant height up to 3 m.

The scope of chain cable, being the ratio between the length of chain paid out and water depth, is assumed to be to the maximum possible and not less than 3.

### 2 Anchoring equipment

#### 2.1 Equipment number for deep and unsheltered water

**2.1.1** The equipment number for deep and unsheltered water  $EN_1$  is to be obtained from the following formula:

$$EN_1 = 0,628 \left[ a \left( \frac{EN}{0,628} \right)^{2,3} + b(1-a) \right]^{2,3}$$

where:

$$a = 1,83 \cdot 10^{-9} \cdot L_E^3 + 2,09 \cdot 10^{-6} \cdot L_E^2 - 6,21 \cdot 10^{-4} \cdot L_E + 0,0866$$

$$b = 0,156 \cdot L_E + 8,372$$

$EN$  : Equipment Number as defined in Pt B, Ch 9, Sec 4, [1.2.2]

$L_E$  : Equipment length  $L_E$  of the ship as defined in Pt B, Ch 9, Sec 4, [1.2.2].

**2.1.2** Anchors and chain cables are to be in accordance with Tab 1 and based on the Equipment Number for deep and unsheltered water  $EN_1$ .

#### 2.2 Anchors

**2.2.1** In addition to the provisions of Pt B, Ch 9, Sec 4, [2.1]:

- Anchors are to be of the stockless High Holding Power (HHP) type
- The mass of the head of stockless anchor, including pins and fittings, is not to be less than 60% of the total mass of the anchor
- The mass of individual anchors may differ by  $\pm 7\%$  from the mass required for each anchor, provided that the total mass of anchors is not less than the total mass required in Tab 1.

#### 2.3 Chain cables for bower anchors

**2.3.1** In addition to the provisions of Pt B, Ch 9, Sec 4, [2.2], bower anchors are to be associated with stud link chain cables of grade Q2 or Q3 as given in Tab 1. The total length of chain cable is to be divided in approximately equal parts between the two anchors ready for use.

#### 2.4 Anchor windlass and chain stopper

**2.4.1** Anchor windlass, chain stopper and supporting structure of anchor windlass and chain stopper are to comply with Pt B, Ch 9, Sec 4, [2.5] and Pt B, Ch 9, Sec 4, [2.6], unless otherwise specified.

**2.4.2** Notwithstanding the requirements of [2.4.1], the windlass unit prime mover is to be able to supply for at least 30 minutes a continuous duty pull  $Z_{cont}$  in N, given by:

$$Z_{cont} = 35d^2 + 13,4 m_A$$

where:

$d$  : Chain diameter, in mm, as per Tab 1

$m_A$  : HHP anchor mass, in kg, as per Tab 1.

**2.4.3** In addition to [2.4.1], for testing purpose, the speed of the chain cable during hoisting of the anchor and cable is to be measured over 37,5 m of chain cable and initially with at least 120 m of chain and the anchor submerged and hanging free. The mean speed of the chain cable during hoisting of the anchor from the depth of 120 m to the depth of 82,5 m is to be at least 4,5 m/min.

Where the available water depth is insufficient, an equivalent test method, compensating the missing hanging chain weight, is to be submitted for special examination by the Society. In case the test method is not considered equivalent, the maximum water depth associated to the additional class notation **UNSHeltered ANCHORING** is to be limited to the tested depth and specified in a memoranda.

Table 1 : Anchoring equipment for ships in unsheltered water with depth up to 120m

Equipment number EN <sub>1</sub> A < EN <sub>1</sub> ≤ B		High Holding Power (HHP) stockless bower anchors		Stud link chain cables for bower anchors		
		Number of anchors	Mass per anchor, in kg	Total length, in m	Diameter, in mm	
A	B				Q2	Q3
–	1790	2	14150	1017,5	105	84
1790	1930	2	14400	990	105	84
1930	2080	2	14800	990	105	84
2080	2230	2	15200	990	105	84
2230	2380	2	15600	990	105	84
2380	2530	2	16000	990	105	84
2530	2700	2	15900	990	105	84
2700	2870	2	15800	990	105	84
2870	3040	2	15700	990	105	84
3040	3210	2	15600	990	105	84
3210	3400	2	15500	990	105	84
3400	3600	2	15400	990	105	84
3600	3800	2	16600	990	107	87
3800	4000	2	17800	962,5	107	87
4000	4200	2	18900	962,5	111	90
4200	4400	2	20100	962,5	114	92
4400	4600	2	22000	962,5	117	95
4600	4800	2	22400	962,5	120	97
4800	5000	2	23500	962,5	124	99
5000	5200	2	24000	935	127	102
5200	5500	2	24500	907,5	132	107
5500	5800	2	25000	907,5	132	107
5800	6100	2	25500	880	137	111
6100	6500	2	25500	880	142	114
6500	6900	2	26000	852,5	142	117
6900	7400	2	26500	852,5	147	117
7400	7900	2	27000	825	152	122
7900	8400	2	27000	825	–	127
8400	8900	2	27000	797,5	–	127
8900	9400	2	27000	770	–	132
9400	10000	2	27000	770	–	137
10000	10700	2	27000	770	–	142
10700	11500	2	27000	770	–	142
11500	12400	2	29500	770	–	147
12400	13400	2	31500	770	–	152
13400	14600	2	34500	770	–	157
14600	–	2	38000	770	–	162

## SECTION 24

## SCRUBBER READY

### 1 General

#### 1.1 Scope of this notation

##### 1.1.1 Purpose of additional notation SCRUBBER READY

The purpose of additional class notation **SCRUBBER READY** is to have the ship prepared for a later installation of an Exhaust Gas Cleaning System (EGCS).

##### 1.1.2 Timing for granting of the additional notation SCRUBBER READY

This notation is normally granted during the construction of the ship in accordance with Pt A, Ch 1, Sec 2, [6.8.14]. It can also be granted for existing ships during an overhaul phase, where it is decided that the installation of an EGCS would be postponed to a later opportunity.

##### 1.1.3 Installation of the exhaust gas cleaning system

The installation of the exhaust gas cleaning system in itself is not covered by this notation. This means that this notation does not cover:

- the class approval of the different parts of the EGCS, including, piping systems, tanks, pressure vessels, pumps, control systems. However, it is supposed that above mentioned items will fulfil the Class requirements when they are installed onboard
- the statutory approval of the different parts of the EGCS.

External openings, inlets and discharges involved by the EGCS, especially those located below the water lines are normally included into the scope of this additional notation in order to avoid dry-docking when the rest of the modifications do not require to (e.g. tank installations might require dry-docking).

##### 1.1.4 Selection of an EGCS

- a) the type and Manufacturer of the EGCS is to be declared to the Society by the Yard in agreement with the Owner
- b) the declared EGCS should be of an approved type
- c) the chosen system may be replaced by another system issued by another Manufacturer with similar characteristics when installed. In this case, the Society will give special consideration when discrepancies between the system considered during application of the additional class notation **SCRUBBER READY** and the actually

installed EGCS may require adjustments to the design proposed by Yard during the application of the additional class notation **SCRUBBER READY**.

##### 1.1.5 Review of actual modifications during EGCS installations

Modifications undertaken during actual installation of the EGCS is to be reviewed as mentioned in Pt A, Ch 1, Sec 1, [3.3].

**1.1.6** When the EGCS is actually installed on-board, the additional class notation **SCRUBBER READY** will be replaced by the additional class notation **EGCS-SCRUBBER**, provided that all the applicable requirements are complied with. See Pt A, Ch 1, Sec 2, [6.8.12].

### 2 Documentation to be submitted

#### 2.1 Status of the documentation

**2.1.1** The documentation submitted to the Society in the scope of additional class notation **SCRUBBER READY** will be stamped as “examined” unless drawings are describing items actually installed during construction or maintenance period where the notation is granted.

#### 2.2 List of documents

**2.2.1** The documents to be submitted to the Society are listed in Tab 1.

### 3 Requirements for the additional class notation SCRUBBER-READY

#### 3.1 General arrangement

**3.1.1** The initial or modified design of the ship is to take into account the necessary spaces or zones to accommodate the following installations:

- Scrubber process tank(s)
- Pumps
- Ventilation systems
- Scrubber(s) tower(s)
- Treatment system(s), if applicable
- Access arrangements to added/modified compartment.

Table 1 : List of documents

No.	Document
GENERAL	
1	Manufacturer and type of system chosen for the application of the notation <b>SCRUBBER READY</b>
2	General arrangement of the ship taking into account the installation of the EGCS
3	Characteristics regarding weight and volume for the main equipment and auxiliaries included in the EGCS and not part of the ship list of equipment before modification
4	Electric and fresh water consumption of the EGCS
5	List of the additional treatment products needed for the proper operation of the EGCS, the Material Safety Data Sheet of these products and recommendations of the Manufacturer and the associated risk analysis
6	The operation Manual of the EGCS
7	Risk analysis about availability of essential systems of ship related to failure of EGCS system (see Pt C, Ch 1, Sec 10, [18.5.3])
HULL	
8	Diagram of scrubber installation, fixation diagram, strength calculation for scrubber transverse supports
9	Holes and penetration drawing
10	Funnel transformation drawing, as necessary
11	Casing transformation drawing, as necessary
12	Tank and Capacity Plan taking into account the installation of the EGCS
13	Details of structure modification intended for the EGCS installation
MACHINERY	
14	Modification on boilers fitted with an EGCS if any and the associated piping systems
15	Drawing of the piping systems connected to the EGCS through pipes or tanks, as foreseen after the installation of the EGCS, including existing and new portions of piping.
16	Drawing of new portions of piping systems related to the installation of the EGCS. This drawing should mention hazardous areas where these piping systems might be installed
17	Drawing of the bilge system including portions serving the compartments where elements of the EGCS are located
17	Pressure drop calculation inside the exhaust gas systems after the installation of the EGCS
19	Arrangement drawing of the machinery spaces involved by the installation of the EGCS
20	Arrangement drawing of the replenishment areas for specific products related to the EGCS
21	Fresh water production and consumption balance when the EGCS needs supply of fresh water
22	Heat tracing for EGCS piping systems
23	Details of the discharge outlets for the EGCS
24	Details of the EGCS inlets for ships navigating in the ice, including the way the EGCS will be operated in this case
ELECTRICITY & AUTOMATION	
25	Electrical power balance, taking into account the EGCS installation
26	Short-circuits current calculation taking into account the EGCS installation (where maximum symmetrical short circuit currents in the main switchboard exceed 50 KA)
27	Technical documentation showing the general arrangement of major electrical components (Power and Distribution Panels, Electrical Motors, etc.)
28	Power Supply arrangement, (depicting Stand-by Power Supply for control system)
29	Single Line Diagram of the Control System
30	Bill of materials used in the automation circuits and references (Manufacturer, type, etc.)
31	List of monitored parameters for alarm/monitoring and safety systems (System's Alarm is to be in line with the requirements as per Pt C, Ch 1, Sec 10, Tab 35)
32	List of electrical cables to be installed along with their relevant type approval certificates.
33	Block diagram showing the interfacing between existing systems and the automation system of the EGCS

No.	Document
FIRE SAFETY	
34	Fire control Plan, updated
35	Diagrams of ventilation/extinction/detection installations if modified or in case of creation of new compartments
36	Categorization of spaces according to Pt C, Ch 4, Sec 5 taking into account the installation of the EGCS with the history of the previous space categorization and type approved/Med (if applicable) certification of the new installed pieces of equipment
37	Status of modified fire fighting systems induced by the installation of the EGCS, as necessary
38	Drawing showing escape routes taking into account the installation of the EGCS, as necessary
STABILITY	
39	Damage control Plan, as necessary
40	Damage Stability Booklet, as necessary
41	Intact stability calculation taking into account the installation of the EGCS
42	Damage stability calculation taking into account the installation of the EGCS, as necessary

### 3.2 Hull items

**3.2.1** The documentation listed in Tab 1 is to contain, as a minimum, the information needed to ensure that:

- the ship design related to internal structure, whenever modified or not, is able to bear the different components of the EGCS, such as the exhaust gas cleaning device in itself, tanks, pumps and other newly installed piece of equipment, in accordance with the classification Rules
- the existing ship structures are able to bear parts of the EGCS when installed outside the structure (eg: dry scrubber installed on deck), in accordance with the classification Rules
- the existing ship structures newly assigned to the operation of the EGCS fit to this new function (eg: existing tanks receiving treatment products or used as retention tank might need a specific coating)
- the scantlings of hull in way of the new hull openings complies with applicable requirements of the classification Rules
- the elements of the EGCS installation are taken into account in the general arrangement of the vessel in accordance with Rule requirements
- the ship remains compliant with the rules for anchoring and mooring, taking into account the increased windage area due to modified funnel, if relevant.

Note 1: Regarding the sea water systems, the attention of the shipyards is drawn on the proper dimensioning of those lines serving EGCS installations.

### 3.3 Machinery items

**3.3.1** The documentation listed in Tab 1 is to contain, as a minimum, the information needed to ensure that:

- the reserved machinery spaces provide sufficient room for the EGCS. If parts of the EGCS need to be installed outside internal compartments, this review is to be extended as necessary to the exposed decks
- the new piping systems are interconnected to the existing ones in such a way that the working of the already existing installations is not jeopardized and fulfills the

Classification Rules. In particular, means for isolation should already be considered: as a principle, piping systems dedicated to the EGCS are normally not to be permanently connected with other piping systems

Note 1: Attention is drawn on the proper dimensioning of the lines of seawater systems serving EGCS installations.

- the new piping systems are installed in areas fitting to the material used for piping according the Classification Rules (eg: plastic pipes should be carefully selected when installed in hazardous areas)
- the pressure drop inside the exhaust line, taking into account the installation of the EGCS, would not overpass the allowances established by the engine or boiler Manufacturer. If additional modifications like the installation of other equipment on the exhaust lines (eg economizer, SCR) is planned during the EGCS installation, these elements are also to be taken into account
- the tanks newly created or re-assigned are fitted with the proper piping systems as described in Pt C, Ch 1, Sec 10, [18.5]
- the treatment product tanks, if any, are properly arranged (see Pt C, Ch 1, Sec 10, [18.5])
- the means to handle products necessary for the EGCS are properly located and designed
- the production of fresh water on board will be enough to supply the needs of the ship together with the EGCS
- heat tracing is available for piping systems carrying liquid substances that are likely to solidify on external cool weather conditions, if any
- for ship navigating in ice, as a minimum, the operation of the ship at the minimum power allowed for ice condition could be possible with EGCS installations connected to ice sea chests
- the discharge outlets from the EGCS are not located too close from a sea water inlet. A minimum of 4 meters is to be considered unless it can be demonstrated that no water with a pH less than 7 could be pumped through the inlets

- l) the design of the discharge outlets from the EGCS is compliant with statutory requirements as mentioned in MARPOL Annex VI Reg.4 and MEPC.259(68). This should be checked on the basis of the documentation provided with the chosen EGCS design
- m) the additional hull openings not used before the installation of the EGCS are fitted with:
  - a discharge valve in closed position, not connected to the remote control system
  - a blind flange inboard
  - a notice mentioning that the valve should not be operated.

### 3.4 Electricity items

**3.4.1** The documentation listed in Tab 1 is to contain, as a minimum, the information needed to ensure that:

- a) the electric load balance is taking into account the new installation of the EGCS
- b) the emergency lighting fittings, fire detectors, flooding detection and internal communication systems are provided in EGCS Room/area
- c) the capacity of main switchboard and local distribution busbars is sufficient when EGCS is taken into account
- d) the short circuit calculation is updated taking into account the EGCS
- e) the existing automated systems provide the proper interfacing with the EGCS automation system, in particular the EGCS-IAS and EGCS-GNSS interfaces.

### 3.5 Safety items

**3.5.1** The documentation listed in Tab 1 is to contain, as a minimum, the information needed to ensure that:

- a) the categorization of compartments according to Pt C, Ch 4, Sec 5 is updated taking into account the installation of the EGCS
- b) the fire fighting systems are updated according to Pt C, Ch 4, Sec 6 taking into account the installation of the EGCS
- c) the escape routes are updated according to Pt C, Ch 4, Sec 8 taking into account the installation of the EGCS
- d) the ventilation systems are updated taking into account the installation of the EGCS.

### 3.6 Stability items

**3.6.1** The documentation listed in Tab 1 is to contain, as a minimum, the information needed to ensure that:

- a) the internal bulkheads properties are not changed. Otherwise, re-assessment of the damage stability is to be undertaken, when relevant
- b) the stability criteria applicable to the type of ship considered are still fulfilled after the installation of the EGCS. This assessment is to include not only the weight of the equipment installed but also the weight of the liquid contained normally inside the tanks and piping systems when the EGCS is operated
- c) the change in lightship parameters requires a new inclining experiment or a weighing test or not. In the affirmative case, it is to be mentioned in the ship certificate that this experiment or test needs to be undertaken after the EGCS installation.

## SECTION 25

## GAS-PREPARED SHIPS

### 1 General

#### 1.1 Application

**1.1.1** The additional class notation **GAS-PREPARED** is assigned, in accordance with Pt A, Ch 1, Sec 2, [6.14.35], to new ships that are designed with specific arrangements to accommodate future installation of an LNG fuel gas system, in accordance with the requirements of this Section.

**1.1.2** The additional class notation **GAS-PREPARED** may be completed by one or by a combination of the following notations:

- **S** when specific arrangements are implemented for the ship structure
- **P** when specific arrangements are implemented for piping
- **ME-DF** when the main engine(s) is (are) of the dual fuel type
- **AE** when the auxiliary engines are either of the dual fuel type, or designed for future conversion to dual fuel operation
- **B** when the oil-fired boilers are either of the dual fuel type, or designed for future conversion to dual fuel operation.

Examples of notations are given below:

- **GAS-PREPARED**
- **GAS-PREPARED (P)**
- **GAS-PREPARED (P, ME-DF)**

**1.1.3** When the ship is effectively converted to dual-fuel operation, the additional class notation **GAS-PREPARED** will be replaced by the additional service feature **LNGfuel dualfuel**, provided that all the applicable requirements are complied with. See Pt A, Ch 1, Sec 2, [4.13].

#### 1.2 Documents and information to be submitted

**1.2.1** The documentation submitted to the Society in the scope of additional class notation **GAS-PREPARED** will be stamped as “examined” unless drawings are describing items actually installed during construction or maintenance period where the notation is granted.

**1.2.2** The plans and documents to be submitted are listed in Tab 1.

#### 1.3 Definitions

##### 1.3.1 Fuel gas handling system

Fuel gas handling system means the equipment necessary for processing, heating, vaporizing or compressing the LNG or gas fuel.

##### 1.3.2 Gas valve unit (GVU)

Gas valve unit means a set of shut-off valves, venting valves, pressure control valve, gas flow meter, filter and gas pressure/temperature transmitters and gauges, located on the gas supply to each gas consumer.

##### 1.3.3 Gas combustion unit (GCU)

Gas combustion unit means a system intended for the combustion of boil-off gas in excess.

##### 1.3.4 Dual-fuel

Dual-fuel applies to engines and boilers designed for operation with oil fuel only or gas fuel only (or in some cases with oil fuel and gas fuel in variable proportions).

##### 1.3.5 Gas-related space

Gas-related space means a space containing:

- installations or equipment intended for the storage, handling and supply of LNG or gas fuel
- gas consumers (engines, boilers or GCU).

##### 1.3.6 Gas-convertible

Gas-convertible applies to engines and boilers that are:

- designed and approved for oil fuel operation
- capable of being subsequently converted to dual fuel operation, and
- for which a conversion method has been approved by the Society.

## 2 Requirements for the additional class notation GAS-PREPARED

### 2.1 General arrangement

**2.1.1** The initial design of the ship is to take into account the necessary spaces or zones to accommodate the following installations:

- LNG bunkering station
- LNG storage tanks
- fuel gas handling system
- ventilation systems
- GVU
- GCU, where required by NR529
- vent mast.

Note 1: NR529 Gas Fuelled Ships.

**2.1.2** The arrangement and location of gas-related spaces are to comply with the provisions of NR529.

**2.1.3** The access to gas-related spaces is to comply with the provisions of NR529. Where required, air locks are to be provided.

**Table 1 : Documents and drawings to be submitted**

Notation	No.	Documents and information to be submitted	Approval status (A/I) (1)
<b>GAS-PREPARED</b>	1	General arrangement drawing of the ship showing the gas-related spaces and installations, either fitted at the new building stage or planned at a subsequent stage (2), in particular: <ul style="list-style-type: none"> <li>• the LNG bunkering station(s)</li> <li>• the LNG tanks</li> <li>• the fuel gas handling system</li> <li>• the GUV space(s)</li> <li>• the GCU (where fitted)</li> <li>• the vent mast(s)</li> </ul>	A
	2	General specification of the contemplated LNG/gas fuel installation including: <ul style="list-style-type: none"> <li>• type and capacity of the LNG storage tanks</li> <li>• bunkering method (from terminal, bunker ship or barge, or truck)</li> <li>• boil-off management principle</li> </ul>	I
	3	Drawing showing the hazardous areas and their classification, assuming that all LNG/gas installations are fitted onboard	A
	4	Drawing showing the structural fire protection and cofferdams provided in connection with LNG/gas installations	A
	5	Longitudinal strength calculation and stability calculation covering the loading conditions assuming the LNG installation in ready-for-use condition	A
	6	Arrangement of accesses to the gas-related spaces	A
	7	Arrangement of the ventilation systems serving the gas spaces	A
	8	Calculation of the hull temperature in all the design cargo conditions	A
	9	Distribution of quality and steel grades in relation to the values obtained from the hull temperature calculation	A
	10	For main engine of gas-convertible type: <ul style="list-style-type: none"> <li>• details of the gas conversion</li> <li>• list of the components that need to be replaced (e.g. cylinder heads)</li> <li>• list of new components (e.g. gas supply valves, pilot injection system)</li> <li>• reference of Approval</li> </ul>	I
	11	HAZID analysis (see [2.1.6])	I
<b>S</b>	12	Structure drawings for all gas-related spaces: bunkering station, LNG tank holds, gas fuel handling room, GUV room	A
	13	Calculations of the local structural reinforcement in way of the LNG tanks	A
<b>P</b>	14	Schematic diagram and arrangement of the LNG and gas piping systems, including venting systems	A
	15	Arrangement of the venting mast	A
<b>ME-DF</b>	16	Reference of type approval for the dual fuel main engine	I
<b>AE</b>	17	For auxiliary engines, documents as par item 10	I
<b>B</b>	18	For boilers, documents as par item 10	I
<p>(1) A : Document to be submitted for approval I : document to be submitted for information.</p> <p>(2) The equipment and systems installed at the new building stage and those intended to be installed at a subsequent stage are to be clearly identified on the drawing.</p>			



**2.1.4** The hazardous / non-hazardous area classification of the gas-related spaces is to be defined in accordance with the provisions of NR529.

**2.1.5** The ship ventilation is to be arranged in accordance with the provisions of NR529, in particular as regards the separation between the ventilation systems serving hazardous areas and those serving the non-hazardous areas.

**2.1.6** An HAZID analysis is to be conducted to ensure that risks arising from the use of gas fuel are addressed. Loss of function, component damage, fire, explosion and electric shock are as a minimum to be considered.

## **2.2 Hull and Stability**

**2.2.1** The ship stability is to be assessed for preliminary loading conditions, assuming the LNG installation in ready-for-use condition, and to comply with the relevant provisions of Part B, Chapter 3. The relevant loads are to be stated.

**2.2.2** The longitudinal strength of the ship is to be assessed, assuming the LNG installation in ready-for-use condition, and to comply with the relevant provisions of Part B.

**2.2.3** Hull material in way of the LNG storage tanks is to be selected in relation to the values obtained from the hull temperature calculation. See NR529, Regulation 6.4.13 and Table 7.5.

## **2.3 Machinery**

**2.3.1** All gas-related installations and equipment that are fitted to the ship at the initial design stage are to comply with the relevant provisions of NR529.

**2.3.2** Main engines are to be of dual fuel approved type or gas-convertible type.

## **3 Additional requirements for notations S, P, ME-DF, AE and B**

### **3.1 Notation S**

**3.1.1** The structure of the gas-related spaces is to be built in compliance with the relevant provisions of the structural rules applicable to the ship.

**3.1.2** The local structural reinforcements in way of the tanks are to be justified by calculation and effectively fitted onboard the ship.

### **3.2 Notation P**

**3.2.1** The initial design of the ship is to take into account the spaces intended for the future installations of the LNG and gas fuel piping systems.

### **3.3 Notation ME-DF**

**3.3.1** The main engine is to be of dual fuel approved type.

### **3.4 Notation AE**

**3.4.1** The auxiliary engines are to be of dual fuel approved type or gas-convertible type, as defined in [1.3.6].

### **3.5 Notation B**

**3.5.1** The boilers are to be of dual fuel approved type or gas-convertible type, as defined in [1.3.6].

## SECTION 26

## ULTRA-LOW EMISSION VESSEL (ULEV)

## Symbols

$n$	: Engine speed, in r/min
$n_{hi}$	: Engine high speed, i.e. highest engine speed where 70% of the maximum power occurs
$n_{lo}$	: Engine low speed, i.e. lowest engine speed where 50% of the maximum power occurs
$n_{max}$	: 100% speed for the corresponding test cycle
$P$	: Engine power, in kW
$P_{max}$	: Maximum power in kW as designed by the engine manufacturer.

## 1 General

## 1.1 Scope

**1.1.1** This Section applies to ships fitted with internal combustion engines having the capacity to emit gaseous pollutants and particular pollutants at a very low level at the time of assignment of **ULEV** additional class notation. The engines may have the capacity to emit a low level of pollutants in a specific operating mode only, hereafter referred to as "ULEV Mode".

The assignment of **ULEV** additional class notation as defined in Pt A, Ch 1, Sec 2, [6.8.15] is based on the information provided for each engine according to the requirements of this Section.

When granting **ULEV** additional class notation, a memorandum is to be endorsed in order to record the list of engines covered, the fuel(s) with which they have been tested and their ULEV mode if any.

## 1.2 Application

## 1.2.1 Engines

All internal combustion engines installed on board are to be in compliance with the requirements of this Section, except:

- engines intended to be used only for emergencies, or solely to power any device or equipment intended to be used only for emergencies on the ship on which it is installed, or engines installed in lifeboats intended to be used only for emergency
- engines with a power equal to or less than 19kW, other than:
  - main propulsion engines; and
  - engines driving electric generators including emergency generator.

**1.2.2 ULEV** additional class notation may be assigned to sea-going ships. The requirements of this Section do not apply to vessels dedicated to operations on inland waterways (including estuaries, rivers, estuary and lakes) falling into the scope of EU Regulation 2016/1628.

**1.2.3 ULEV** additional class notation may be assigned to new constructions or to ships in service as long as the engines installed on board, defined in [1.2.1], comply with the requirements of this Section.

Table 1 : Documents to be submitted

No.	Item	I/A
1	For each engine: Engine particulars, including exhaust after-treatment system particulars (e.g. Data sheet with general engine information, details of parameters, including engine components, settings and fuel specifications, that may influence the emissions of pollutants, Project Guide, Marine Installation Manual or installation recommendations)	I
2	If applicable, diagram of the reagent dosing system and associated control system	I
3	For each engine: Emission monitoring system specification, if applicable	I
4	For each engine or parent engine: Emission test program	I
5	For each engine or parent engine: Emission test report	A
6	For each engine's test report: If applicable, definition of the engine family and parent engine, and justification for the selection of the parent engine	A
7	For each engine: Accreditation certificate of the testing laboratory or other document showing compliance with [4.2.2]	I
8	For each engine: Engine maintenance manual, including after-treatment system maintenance manual	I
9	List of all engines installed on board including their purpose and serial number	A
10	General arrangement of the engine, exhaust piping and exhaust after-treatment system on the leadership, if applicable, and on the ULEV sistership	I
<b>Note 1:</b> I: For information; A: For approval		

### 1.3 Documents to be submitted

1.3.1 The documents listed in Tab 1 are to be submitted:

- Documents 1 to 8, as applicable, for each engine, including the after-treatment system if installed
- Documents 9 and 10, as applicable, for the whole ship.

## 2 Definitions

### 2.1

2.1.1 “Auxiliary engine” means an engine that does not directly or indirectly provide propulsion.

2.1.2 “Emission control system” means any device, system or element of design that controls or reduces emissions.

2.1.3 “Engine type” means a group of engines which do not differ in essential engine characteristics.

2.1.4 “Engine family” means a manufacturer's grouping of engine types which, through their design, have similar exhaust emission characteristics, and respect the applicable emission limit values.

2.1.5 “Engine operating mode” means a configuration of the engine control system.

2.1.6 “Gaseous pollutants” means the following pollutants in their gaseous state emitted by an engine: carbon monoxide (CO), total hydrocarbons (HC) and oxides of nitrogen (NO<sub>x</sub>); NO<sub>x</sub> being nitric oxide (NO) and nitrogen dioxide (NO<sub>2</sub>), expressed as NO<sub>2</sub> equivalent.

2.1.7 “Internal combustion engine” or “engine” includes, where they have been installed, the emission control system and the communication interface (hardware and messages) between the engine's electronic control unit(s) and any other powertrain or machinery control unit necessary to comply with the requirements of this notation.

2.1.8 “NO<sub>x</sub> Control Diagnostic system (NCD)” means a system on board the engine which has the capability of detecting a NO<sub>x</sub> Control Malfunction, and identifying its likely cause by means of information stored in computer memory.

2.1.9 “Parent engine” means an engine type selected from an engine family in such a way that its emissions characteristics are representative of that engine family.

2.1.10 “Particle number” or “PN” means the number of solid particles emitted by an engine with a diameter greater than 23 nm.

2.1.11 “Particulate Control Diagnostic system (PCD)” means a system on board the engine which has a capability of detecting a Particulate Control Malfunction and identifying its likely cause by means of information stored in computer memory.

2.1.12 “Particulate matter” or “PM” means the mass of any material in the gas emitted by an engine that is collected on a specified filter medium after diluting the gas with clean filtered air so that the temperature does not exceed 325 K (52°C).

2.1.13 “Particulate pollutants” means any matter emitted by an engine that is measured as PM or PN.

2.1.14 “Propulsion engine” means any engine other than an auxiliary engine.

2.1.15 “ULEV sister ship” means a sister ship as defined in Pt B, Ch 1, Sec 2, [3.23.1]. Especially, it means that the engines and emission control system types and arrangement on board are identical to that on the leader ship.

## 3 Requirements for ULEV additional class notation

### 3.1 Requirements for the engines

#### 3.1.1 Engine testing and design

Compliance with the requirements of [3.2] is to be demonstrated through testing of an engine type as per [4].

Note 1: Engines type-approved in the scope of EU regulation 2016/1628 may be accepted without further testing, provided that satisfactory documentation is submitted to the Society.

3.1.2 Testing on a parent engine may be accepted to demonstrate that the whole engine family complies with the requirements of [3.2]. For this purpose, the parent engine is to be selected by the engine manufacturer, such that the parent engine incorporates those features that will most adversely affect the pollutant emission level. This engine, in general is to have the highest gaseous and particulate pollutant emission level among all of the engines in the engine family.

Parent engine and engine family are to be defined taking into account the emission control system where fitted.

#### 3.1.3

Testing on a reference engine may be accepted to demonstrate that other engines of the same design installed on board comply with the requirements of [3.2] For this purpose, the reference engine is to be selected in order to incorporate those arrangements on board that will most adversely affect the pollutant emission level. This engine, in general is to have the highest gaseous and particulate pollutant emission level among all of the engines of the same design installed on board.

The reference engine is to be defined taking into account the emission control system where fitted.

3.1.4 It may be considered by the Society that satisfactory measurements performed on the leader ship cover the engines installed on an ULEV sister ship, provided the engines, exhaust lines and emission control systems are documented as identical to the types of the ULEV sister ship.

## 3.2 Emission levels

**3.2.1** The emissions of each engine installed on board, parent engine or reference engine, are to be shown to remain below the thresholds given in Tab 2, based on measurements as detailed in [4]:

**Table 2 : Maximum emission levels for ULEV additional class notation**

Power range (1)	CO	HC (2)	NO <sub>x</sub>	PM mass	PN
kW	g/kWh			#/kWh	
110 ≤ P < 130	5,00	(HC + NO <sub>x</sub> ≤ 5,40)		0,14	–
130 ≤ P < 300	3,50	1,00	2,10	0,10	–
P ≥ 300	3,50	0,19	1,80	0,015	10 <sup>12</sup>

(1) P is the engine power, in kW  
 (2) For gas fuelled engines and dual fuel engines in gas mode, the maximum allowable HC emission level is to be taken as the lower of:

- 6,19 and
- 0,19 + (9 × GER))

Where GER is the average gas energy ratio over the test cycle defined in [4.2.5].

## 3.3 Emission control monitoring

### 3.3.1 NO<sub>x</sub> control diagnostic

Electronically controlled engines using electronic control either to determine both the quantity and timing of injecting fuel; or to activate, de-activate or modulate the emission control system used to reduce NO<sub>x</sub> are to be equipped with a NO<sub>x</sub> Control Diagnostic system (NCD) able to identify the NO<sub>x</sub> control malfunctions and their likely causes.

The NCD system is to conclude within 60 minutes of engine operation whether a detectable malfunction is present and, in this case, it is to trigger a visual alarm in the engine control room. It is to be possible to identify which malfunction has been detected.

The NCD system is to record each NO<sub>x</sub> control malfunction under a specific code and store it in the onboard computer.

Note 1: A NO<sub>x</sub> control malfunction is an attempt to tamper with the NO<sub>x</sub> control system of an engine or a malfunction affecting that system that might be due to tampering. NO<sub>x</sub> control malfunctions include:

- Impeded exhaust gas recirculation (EGR) valve, and
- Failures of the NO<sub>x</sub> Control Diagnostic (NCD) system.

### 3.3.2 NO<sub>x</sub> reagent monitoring

When the NO<sub>x</sub> control emission includes the use of a reagent, the following parameters are to be monitored:

- level of reagent in the reagent tank

- reagent quality or concentration, or NO<sub>x</sub> concentration
- interruption of reagent dosing.

Inadequate values of these parameters are to trigger a distinct visual alarm in the engine control room. Related incidents are to be recorded in the onboard computer.

### 3.3.3 Particulate control diagnostic

Engines fitted with a particulate after-treatment system are to be equipped with a Particulate Control Diagnostic system (PCD) able to identify the particulate after-treatment system malfunctions.

In cases where the NO<sub>x</sub> control system and the particulate control system share the same physical components (e.g. same substrate, same exhaust gas temperature sensor), these components may be monitored by the NO<sub>x</sub> Control Diagnostic system only.

The PCD system is to conclude within the periods of engine operation detailed in Tab 3 whether a detectable malfunction is present and, in this case, it is to trigger a visual alarm in the engine control room. It is to be possible to identify which malfunction has been detected.

The PCD system is to record each particulate control malfunction under a specific code and store it in the onboard computer.

Note 1: A Particulate Control Malfunction is an attempt to tamper with the particulate after-treatment system of an engine or a malfunction affecting the particulate after-treatment system that might be due to tampering. Particulate Control Malfunctions include the types detailed in Tab 3.

**Table 3 : Particulate after-treatment system malfunction types and corresponding period within which they are to be detected**

Malfunction type	Period of engine operation within which the malfunction is to be detected and stored
Removal of the particulate after-treatment system	60 minutes of non-idle engine operation
Loss of function of the particulate after-treatment system	240 minutes of non-idle engine operation
Failures of the PCD system	60 minutes of engine operation

## 3.4 ULEV Mode

**3.4.1** Engines with several operating modes are to comply with the requirements of [3.2] in at least one operating mode. The operating mode complying with the requirements of [3.2] is hereafter referred to as “the ULEV mode”.

**3.4.2** The ULEV mode is to be clearly identified in the engine manual and/or shipboard manual and it is to be possible to record when the engine is operating in the ULEV mode or not.

## 4 Emission measurements

### 4.1 Pollutants to be measured

**4.1.1** The brake specific emissions of the following pollutants, in g/kWh, are to be measured over the test cycle defined in [4.2.5]:

- Oxides of nitrogen, NO<sub>x</sub>
- Hydrocarbons, expressed as total hydrocarbons, HC or THC
- Carbon monoxide, CO
- Particulate matter, PM
- Particle number, PN
- Carbon dioxide, CO<sub>2</sub>.

Note 1: Carbon dioxide emissions are to be measured for information only.

### 4.2 Measurements

#### 4.2.1 General

Measurements of the required pollutants are to be carried out according to the requirements of ISO 8178 series or to similar recognized standards or measurement methodologies deemed acceptable by the Society.

**4.2.2** Measurements are to be carried out by a testing laboratory holding an accreditation certificate to ISO/IEC 17025 covering testing methods for the measurement of the required pollutants, which is issued by a national accreditation body.

Note 1: Measurements carried out by, or under the responsibility of, an organisation or body designated as a technical service as defined by EU Regulation 2016/1628 may also be accepted.

**4.2.3** Measurements may be carried out on board or at a testing facility.

**4.2.4** Measurements of each of the required pollutants are to be carried out during the same trial. Each engine subject to measurement is to be tested separately.

#### 4.2.5 Cycle definition

B-Type test cycles as detailed in ISO 8178-4 are to be applied according to the type and operational speed of each engine, as defined in Tab 4.

**Table 4 : B-type ISO 8178 test cycles to be applied**

	Variable speed engine	Constant speed engine
Propulsion engine	E3	E2
Auxiliary engine	C1	D2

**4.2.6** As a complement, for electronically controlled engines using electronic control to determine both the quantity and timing of injecting fuel or using electronic control to activate, de-activate or modulate the emission control system used to reduce NO<sub>x</sub>, emission measurements are to be carried out at control points chosen randomly within the engine control area detailed in [4.5]. The number of control points is detailed in Tab 5.

The brake specific emissions of NO<sub>x</sub>, HC, CO, PM and PN measured at each individual control point are not to exceed the limits given in Tab 2, multiplied by 2.

**Table 5 : Number of control points according to the purpose and operation of the engine**

	Variable speed engine	Constant speed engine
Propulsion engine	2	1
Auxiliary engine	3	1

#### 4.2.7 Crankcase emissions

All crankcase emissions, including emissions normally routed into the exhaust after-treatment system and emissions normally discharged to the ambient atmosphere, are to be routed into the emissions sampling system for measurement purposes. Alternatively crankcase emissions may be added by calculation.

### 4.3 Fuel specification

**4.3.1** For oil-fuelled engines, emission measurements as per [4.2] are to be carried out with the engine running on a fuel complying with ISO 8217 and with the engine manufacturer's specification.

**4.3.2** For engines fuelled with natural gas, emission measurements as per [4.2] are to be carried out with the engine running successively on the reference fuels G<sub>R</sub> and G<sub>20</sub>, without any manual readjustment to the engine fuelling system between the two tests. One adaptation run is permitted after the change of the fuel. The composition of the reference fuels G<sub>R</sub> and G<sub>20</sub> are detailed in Tab 6 and Tab 7.

Note 1: In case where the reference fuels G<sub>R</sub> and G<sub>20</sub> are not available, emission measurements carried out with the engine running on two fuels with a composition different from that of G<sub>R</sub> or G<sub>20</sub> may be accepted provided that:

- The gas fuel compositions comply with the specification of the engine manufacturer, and
- The impact of the composition of the gas fuel is properly documented based on e.g. test reports and engineering analysis, to the satisfaction of the Society.

**Table 6 : Composition of the reference fuel G<sub>R</sub>**

Property	Unit	min.	max.
Molar fraction of methane	mol %	84	89
Molar fraction of ethane	mol %	11	15
Molar fraction of other components (N <sub>2</sub> , C <sub>2</sub> +, other inert components)	mol %	–	1
Mass concentration of sulphur	mg/m <sup>3</sup>	–	10

**Table 7 : Composition of the reference fuel G<sub>20</sub>**

Property	Unit	min.	max.
Molar fraction of methane	mol %	99	100
Molar fraction of nitrogen	mol %	–	–
Molar fraction of other components (C <sub>2</sub> , C <sub>2</sub> +, other inert components)	mol %	–	1
Mass concentration of sulphur	mg/m <sup>3</sup>	–	10

**4.3.3** For engines fuelled with other fuels, emission measurements as per [4.2] are to be carried out with the engine running on fuels complying with the requirements of ISO 8178-5 or of a similar recognized standard deemed acceptable by the Society.

**4.3.4** The fuel composition and properties are to be detailed in the test report.

**4.4 Deterioration factors**

**4.4.1** The values measured according to [4.2] are to be multiplied by the deterioration factors detailed in Tab 8 for the purpose of demonstrating compliance with the emission limits given in [3.2.1].

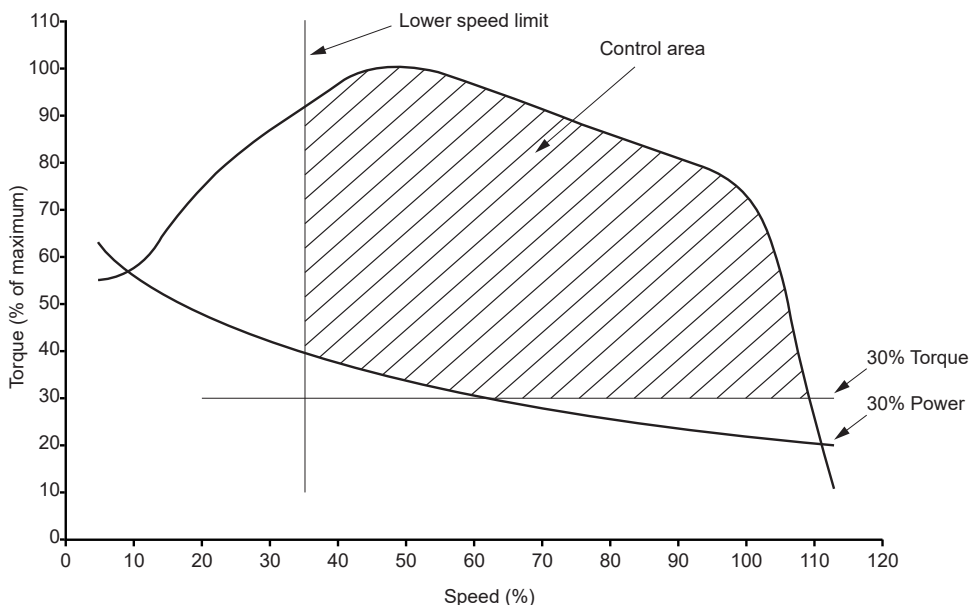
These deterioration factors need not be applied if the pollutant emission measurements are carried out on engines and after-treatment systems that have already been used for more than 10 000 hours.

**Table 8 : Deterioration factors for ULEV additional class notation**

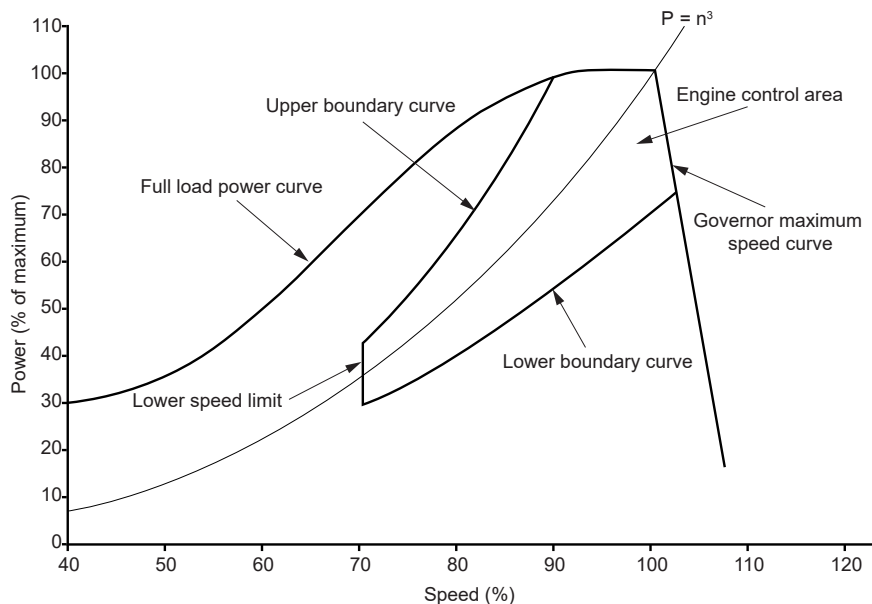
Pollutant	CO	HC	NO <sub>x</sub>	PM	PN
Deterioration factor	1,3	1,3	1,15	1,05	1,0

**4.4.2** Alternatively, case-by-case deterioration factors may be established based on a suitable testing program accounting for ageing of the engine and exhaust after-treatment system during 10 000 hours.

**Figure 1 : Control area for variable speed auxiliary engines**



**Figure 2 : Control area for variable speed propulsion engine**



## 4.5 Control areas

### 4.5.1 Control area for variable speed auxiliary engines

The control area for variable speed auxiliary engines is delimited by the following curves (See Fig 1):

- upper torque limit:  
engine full load torque curve
- lower torque limit:  
30% of maximum torque
- lower speed limit:  
 $n_{lo} + 0,15 \times (n_{hi} - n_{lo})$
- upper speed limit:  
 $n_{hi}$
- points below 30% of maximum net power are excluded from the control area.

In addition, for engines with maximum net power < 300kW and for particulate matter only, the following areas are excluded from the control area:

- if  $n_C < 2\,400$  r/min, points to the right of or below the line formed by connecting the points of 30% of maximum torque or 30% of maximum net power, whichever is greater, at  $n_B$  and 70% of maximum net power at  $n_{hi}$
- if  $n_C \geq 2\,400$  r/min, points to the right of the line formed by connecting the points of 30% of maximum torque or 30% of maximum net power, whichever is greater, at  $n_B$ , 50% of maximum net power at 2400 r/min, and 70% of maximum net power at  $n_{hi}$

where:

$$n_B = n_{lo} + 0,5 \times (n_{hi} - n_{lo})$$

$$n_C = n_{lo} + 0,75 \times (n_{hi} - n_{lo})$$

### 4.5.2 Control area for variable speed propulsion engines

The control area for variable speed propulsion engines is defined as follows (See Fig 2):

- lower speed limit:  
 $0,7 \times n_{max}$
- upper boundary curve:  
 $P/P_{max} = 1,45 (n/n_{max})^{3,5}$
- lower boundary curve:  
 $P/P_{max} = 0,7 \times (n/n_{max})^{2,5}$
- upper power limit:  
full load power curve
- upper speed limit:  
maximum speed permitted by governor.

### 4.5.3 Control area for constant speed propulsion and auxiliary engines

The control area for constant speed engines is defined as:

- speed: 100%
- torque range: between 50% and 100% of the torque corresponding to the engine maximum power.

## 5 Onboard surveys

### 5.1 Initial survey

**5.1.1** An onboard survey is to be undertaken by the Surveyor before granting **ULEV** additional class notation in order to check that the general arrangement and engine particulars are consistent with the submitted documents. In particular, the proper operation of the NCD and PCD systems including the associated alarms and the proper operation of recording of the status of engines when operated in the ULEV mode are to be checked in the presence of the Surveyor.

## SECTION 27

## MAN OVERBOARD DETECTION (MOB)

### 1 Application

#### 1.1 General

**1.1.1** The additional class notation **MOB** is assigned in accordance with Pt A, Ch 1, Sec 2, [6.14.44] to self-propelled ships arranged with means capable of automatically detecting a person going overboard and instantaneously alert the ship's personnel in compliance with the requirements of this Section.

These requirements do not cover man overboard detection systems that require the passengers or crew members to wear or carry a device to trigger an MOB event.

**1.1.2** This notation developed for passengers ships may be assigned to cargo ships at the discretion of Society.

#### 1.2 Reference to other regulations and standard

**1.2.1** The man overboard detection system covered by this Section is to comply with the requirements of the following standard:

ISO/PAS 21195: Ships and marine technology - Systems for the detection of persons while going overboard from ships (Man overboard detection).

#### 1.3 Definitions

##### 1.3.1 Man overboard (MOB) detection system

System designed to automatically detect a person who has gone overboard from the ship.

##### 1.3.2 Man overboard (MOB) event

Incident in which person(s) has accidentally or intentionally gone over the side/front/back of a ship and into the water.

##### 1.3.3 MOB data

Information captured and/or generated by the MOB detection system.

##### 1.3.4 Man overboard (MOB) verification data

System data that may be used by user to acknowledge, deny, confirm, or terminate an MOB alert or alarm at the control station.

##### 1.3.5 False alert

System activation not caused by an actual MOB event.

##### 1.3.6 Sensor unit

Devices or system of devices that detects and responds to one or more physical stimuli.

##### 1.3.7 Control station

Equipment that provides the facilities for human observation and control of the MOB detection system.

##### 1.3.8 Accessible open area

Any area of the ship that is accessible to either passengers or crew members and open to the outside.

#### 1.4 Documents to be submitted

**1.4.1** The documents listed in Tab 1 are to be submitted.

**Table 1 : Documents to be submitted**

No.	I/A (1)	Documentation
1	A	Plan of the ship showing the location of sensor units and the detection envelope of the sensor units
2	A	Functional block diagram of the MOB detection system
3	I	List and specification of components of the MOB detection system (Manufacturer, type...)
4	A	Interconnection diagram with navigational equipment (ECDIS)
5	A	List of MOB alarms
6	I	Operating manual
7	A	Test program including test method
(1) A: to be submitted for approval I : to be submitted for information		



## 2 General design requirements

### 2.1 System description

**2.1.1** The man overboard detection system is to consist of a control station, sensor units, cables, and associated software. All alarms and data are to be available at the control station. Moreover the system is to provide the capability for an operator to manually select an imaging sensor and timeline for playback at the control station.

**2.1.2** The system is to detect persons that pass through the MOB detection zone specified in [2.2] while going overboard, under the environmental conditions specified in [3.3.1] and encountered by the ship during operation.

**2.1.3** The control station of the MOB detection system is to be installed in a permanently manned control station.

**2.1.4** MOB detection system is to be of a type approved by the Society. Type approval is obtained subject to successful outcome of:

- performance tests as per requirements specified in this Section and ISO/PAS 21195 Clause 6
- environmental tests in accordance with Pt C, Ch 3, Sec 6.

### 2.2 MOB detection zone

**2.2.1** The MOB detection zone is to be designed to cover the entire periphery of the ship where passengers or crew members may have access and is to be extended outside the ship at a distance not less than 5 m from the periphery of the ship.

The periphery of the ship is defined as the widest part of the ship at any location and is extended to include lifeboats.

**2.2.2** The sensors units are to be located at or below the lowest accessible open area.

**2.2.3** The sensor units are to be installed so as to prevent any mechanical damages when the ship is in port.

### 2.3 MOB alert and alarm

**2.3.1** Based on data captured from the sensor units the system is to be designed to initiate automatically and immediately at the control station an MOB alert when a person falls down.

**2.3.2** Audible and visual signals are to be activated when an MOB alert is initiated. The visual signal is to remain active until the MOB alert has been acknowledged at the control station. The audible signal is to remain active until the alarm has been deactivated or silenced.

**2.3.3** System is to allow the readily identification of the sensor unit(s) that initiated the MOB alert.

**2.3.4** Within five seconds of the initiation of an MOB alert, MOB data in the form of still or video image is to be made available at the control station.

**2.3.5** System is to generate an MOB alarm log when an MOB alert is initiated. The MOB alarm log is to contain the following information:

- date and time (UTC time) of alleged MOB event
- current ship heading
- current ship position
- current ship speed
- identification of the sensor unit(s) that detect the MOB event
- username(s) of any individual logged into the system.

**2.3.6** The MOB verification data is to permit the operator to deny or confirm an MOB alert from the control station. When an MOB alert is confirmed by an operator, the system escalate the MOB alert to an MOB alarm and is to automatically notify the navigation officers by generating a sound notification and by displaying on the integrated bridge system (IBS) or the electronic chart and information display (ECDIS) the original position when the MOB alert occurs. For that purpose, the system is to generate a NMEA (National Marine Association Message) message (see [2.6.1]).

### 2.4 Data storage

**2.4.1** The data listed in [2.4.2] are to be stored in a resilient and redundant device. The data is to be stamped with date and time. The time code input is to be from a valid coordinated universal time (UTC) feed.

In order to allow post MOB incident analysis, the storage device is to have a capacity to store the required system data for a minimum of 30 days.

The recorded data are to be protected against deletion or overwriting.

**2.4.2** The following data are to be recorded:

- operational status of the system
- operational status of each sensor unit
- data capture from each sensor unit
- any active MOB alarm log (see [2.3.5])
- MOB log entries
- security log (see [2.4.3]).

**2.4.3** Each event on the system (at least: logons, logoffs, data export, software modifications, and system setting changes) is to be recorded in a security log with date and time.

### 2.5 Control system

**2.5.1** The MOB detection system is to be supplied by the transitional source of emergency electrical power. Failure of power supply is to generate an alarm.

**2.5.2** The MOB detection system is to be provided with self-check capability. An alarm is to be activated at the control station when an internal fault is detected.

**2.5.3** The system is to monitor the operational status of the MOB detection system. A display showing the operational status of each components is to be available at the control station.

**2.5.4** The system is to be designed in order to minimize the false alerts caused by external events such as wave action, birds, object falling from the vessel, etc....

**2.5.5** Access to the control station is to be restricted to users with appropriate credentials. Individuals accessing the system are not to have the possibility to alter or delete recorded data. The system is to log user actions.

## 2.6 Events markers

**2.6.1** The MOB NMEA event messages described in [2.3.6] is to be compatible with the Integrated Bridge System (IBS) and Electronic Chart Display and Information System (ECDIS). Any connection to the IBS or ECDIS is to be such that the IBS or ECDIS suffers no deterioration, even if the MOB detection system develops faults.

MOB event messages are to be compliant with NMEA 0183 or NMEA 2000® communication protocols.

The MOB event messages are to be relayed to the IBS or ECDIS provided that the requirements for these systems are not compromised.

Note 1: IEC 61162 series provides additional information on the application of NMEA 2000® aboard SOLAS vessels.

## 2.7 Voyage Data Recorder

**2.7.1** The MOB detection system is to be fitted with an interface that is compatible with the voyage data recorder (VDR). Any connection to VDR is to be such that the VDR suffers no deterioration, even if the MOB detection system develops faults.

The MOB alarm log is to be recorded in a format that complies with international digital interface standards set forth in IEC 61162 using approved sentence formatters.

The MOB alarm log is to be recorded on the VDR provided that the requirements for the recording and storage of the specified data selections are not compromised.

# 3 Survey onboard

## 3.1 General

**3.1.1** Before an installation is put into service and after modification of an existing installation, performance of the MOB detection system is to be evaluated based on the execution of tests in accordance with requirements specified in this Article. Tests are to be carried out under the supervision of Society Surveyor according to an agreed test procedure.

## 3.2 MOB testing manikin

**3.2.1** The system is to be evaluated by using a manikin having a basic human shape that contains two arms, two legs, a torso, and a head. The manikin is to have a mass of 40 kg and a height of 1,467 m, plus or minus 25%. The manikin may be modified to represent the features of a human body for particular sensing modality, such as a warm body for thermal cameras.

## 3.3 Environmental conditions

**3.3.1** As a minimum the system is to be evaluated under the following environmental conditions:

- tests during navigation at different speed, from 0 knots to the ship's rated speed
- tests at different time of the day (night and day) and different sunshine conditions
- tests at different distance from ship's side (from 0 to 5m).

## 3.4 Probability of detection

**3.4.1** The probability of detection of an MOB manikin is to be greater or equal to 95% within the range of environmental conditions set out in the test procedure.

## 3.5 Testing

**3.5.1** The following tests are to be carried out to check the proper functioning of the MOB detection system:

- a) at least 100 drop tests with the MOB manikin under environmental conditions described in [3.3.1] at different locations within each detection zones of the ship
- b) functional test of the control station (activation of MOB alert, MOB alarm log, availability of MOB data, etc...)
- c) behavior of the system in case of internal fault
- d) behavior of the system in case of power failure
- e) transfer of MOB alarm at the navigation bridge
- f) transfer of MOB alarm to the Voyage data Recorder
- g) consequence of failure of MOB detection system on external systems
- h) Access controls of control station

**3.5.2** For each drop test required in [3.5.1] the following information is to be collected and recorded in the test report:

- test date and time
- ship location and heading
- area of the ship where the test has been done
- sensor unit(s) that initiated the MOB alert
- environmental conditions (wave height, weather conditions, etc...).

### 3.6 False alerts

**3.6.1** False MOB alerts are to be collected over a period of 90 days and average over that period. The following parameters are to be captured and recorded with each false alert:

- date and time
- ship location and heading

- sensor unit(s) that initiated the MOB alert
- false alarm reason
- environmental conditions.

**3.6.2** During normal operating conditions, the average number of false alerts over a period of 90 days is not to exceed four per day.

## SECTION 28

## HEADING CONTROL IN ADVERSE CONDITIONS

### 1 General

#### 1.1 Application

**1.1.1** The additional class notations **HEADING CONTROL-DS** and **HEADING CONTROL-IS** may be assigned in accordance with Pt A, Ch 1, Sec 2, [6.14.46], to ships arranged with redundant propulsion and steering systems complying with this Section.

**1.1.2** The purpose of the additional class notations **HEADING CONTROL-DS** and **HEADING CONTROL-IS** is to attest that the ship has redundant propulsion/steering systems in order to maintain its heading to the waves in adverse weather conditions in order to avoid large transversal acceleration taking into account the windage of the deck cargo if any.

**1.1.3** The additional class notation **HEADING CONTROL-DS** is assigned to ships with duplicated propulsion and steering systems able to maintain their heading to the waves in case of single failure on the propulsion or steering system and compliant with the present Section with the exclusion of Article [4].

**1.1.4** The additional class notation **HEADING CONTROL-IS** is assigned to ships with independent propulsion and steering systems complying with the provisions relevant to the notation **HEADING CONTROL-DS** and, in addition, the requirements set in [4] covering the event of fire or flooding casualty in machinery space.

**1.1.5** Machinery, electrical installation and automation are to comply with the relevant provisions of Part C.

#### 1.2 Definitions

##### 1.2.1 Heading to the waves

A ship heading to the waves means that the ship axis remain within  $\pm 30^\circ$  with respect to the waves direction.

##### 1.2.2 Propulsion system

A propulsion system is a system that provides thrust to the ship. It includes:

- the prime mover, including the integral equipment, driven pumps, etc.
- the equipment intended to transmit the torque
- the propulsion electric motor, where applicable
- the equipment intended to convert the torque into thrust
- the auxiliary systems necessary for operation
- the control, monitoring and safety systems.

##### 1.2.3 Steering system

A steering system is a system that controls the heading of the ship. It includes

- the power actuating system
- the equipment intended to transmit the torque to the steering device
- the steering device (e.g. rudder, rotatable thruster, waterjet steering deflector, etc.).

##### 1.2.4 Propulsion auxiliary systems

Propulsion auxiliary systems include all the systems that are necessary for the normal operation of a propulsion system. It includes or may include:

- the fuel oil supply system from and including the service tanks, and the parts of the filling, transfer and purifying systems located in machinery spaces
- the lubricating oil systems serving the engines, the gear-box, the shaftline bearings, the stern tube, etc., and the parts of the lubricating oil filling, transfer and purifying systems located in machinery spaces
- the hydraulic oil systems for operating clutches, controllable pitch propellers, waterjet reverse deflectors, starting systems, etc.
- the fresh water cooling systems serving any component of the propulsion system or used for cooling the fuel oil circuits, the lubricating oil circuits, the hydraulic oil circuits, etc
- the sea water cooling systems used for cooling any component of the propulsion system or any of the aforementioned systems
- the heating systems (using electricity, steam or thermal fluids)
- the starting systems (air, electrical, hydraulic)
- the control air systems
- the power supply (air, electrical, hydraulic)
- the control, monitoring and safety systems
- the ventilation installation where necessary (e.g. to supply combustion air or cooling air to the primer movers).

##### 1.2.5 Steering auxiliary systems

Steering auxiliary systems include all the systems that are necessary for the normal operation of a steering system. It includes or may include:

- the fresh water cooling systems
- the sea water cooling systems
- the control air systems
- the power supply (air, electrical, hydraulic)
- the control, monitoring and safety systems.

### 1.2.6 Safety systems

Safety systems include all the systems that are necessary for the safety of the ship operation. They include:

- fire fighting systems
- bilge system
- communication systems
- navigation lights
- life-saving appliances
- machinery safety systems which prevent of any situation leading to fire or catastrophic damage.

### 1.2.7 System failure

A system failure means any failure of an active component of a propulsion system, steering system or power generation plant, including their auxiliary systems.

Only single failure needs to be considered.

### 1.2.8 Active components

An active component means any component of the main propulsion system or auxiliary propulsion system that transmits mechanical effort (e.g. gear), converts or transfers

energy (e.g. heater) or generates electric signals for any purpose (e.g. control system).

Pipes, manually controlled valves and tanks are not to be considered as active components.

### 1.2.9 Separate compartments

Separate compartments mean compartments which are separated by a fire and watertight bulkhead.

## 1.3 Documents to be submitted

### 1.3.1 HEADING CONTROL-DS

The documents listed in Tab 1 are to be submitted for ships assigned with the additional class notation **HEADING CONTROL-DS**.

### 1.3.2 HEADING CONTROL-IS

In addition to the documents listed in Tab 1, for ships assigned with the additional class notation **HEADING CONTROL-IS**, the documents listed in Tab 2 are to be submitted.

**Table 1 : Documents to be submitted for HEADING CONTROL-DS**

No.	I/A (1)	Document
1	I	Electrical load balance, including one of the propulsion system out of service
2	I	Machinery spaces general arrangement of duplicated propulsion system, steering systems and main electrical components
3	A	Diagram of fuel oil system, lubricating system, hydraulic oil systems, sea water and fresh cooling systems, heating systems, starting air system, control air system, steering system
4	A	Single line diagrams of main electrical distribution system
5	A	Description of the duplicated propulsion system
6	A	Description of the duplicated steering system
7	A	A risk analysis demonstrating the availability of the heading control capability in case of a system failure as defined in [1.2.7] (2)
8	I	An operating manual with the description of the operations necessary to recover the propulsion, steering and safety systems in case of a single failure (see [2.1.1])
9	I	Heading control analysis as described in [2]
10	A	Description of the thrusters system when considered in the heading control analysis
11	A	Failure and casualty scenarios as defined in [3.2]
<p>(1) A : to be submitted for approval I : to be submitted for information</p> <p>(2) The risk analysis may be in the form of a Failure Mode and Effect Analysis (FMEA). Ch 2, App 1 describes an acceptable procedure for carrying out the FMEA.</p>		

**Table 2 : Additional documents to be submitted fro HEADING CONTROL-IS**

No.	I/A (1)	Document
1	I	Description of the independent propulsion system
2	I	Description of the independent steering system
3	A	Bulkhead arrangement of separate machinery spaces
<p>(1) A : to be submitted for approval I : to be submitted for information</p>		

## 2 Heading control analysis

### 2.1 General

**2.1.1** A heading control analysis justifying the ship ability to be steered and maintained head to the wave, from any incoming wave direction and in adverse conditions, is to be submitted to the Society.

**2.1.2** The heading control analysis is to be based on the assumptions defined in [2.2] and [2.3].

**2.1.3** Compliance with the performance criteria set in [2.4] is to be demonstrated.

### 2.2 Environmental adverse conditions

**2.2.1** Adverse conditions mean sea conditions with the following parameters:

- significant wave height  $H_s = 5,5$  m
- peak wave period  $T_p = 7,0$  to  $15,0$  sec
- mean wind speed  $V_w = 19,0$  m/s

Wind and waves are assumed to be coming from the same direction.

### 2.3 Loading conditions

**2.3.1** Typical loading conditions from the approved trim and stability booklet are to be considered including maximum windage area due to the cargo and the ship superstructure.

**2.3.2** The windage area of the ship including its cargo on deck, when relevant, is to be described for each wind direction considered relative to the ship longitudinal axis.

### 2.4 Performance criteria

#### 2.4.1 General

The ship ability to maintain its heading to the waves in the conditions defined in [2.2] and [2.3] is to be justified by compliance with the following criteria:

$$\frac{M_{\text{steer}}}{M_{\text{wind}} + M_{\text{drift}}} \geq 1,15$$

Where:

$M_{\text{wind}}$  : Horizontal (yaw) moment due to the wind (see [2.4.2])

$M_{\text{drift}}$  : Horizontal (yaw) moment due to the wave drift (see [2.4.3])

$M_{\text{steer}}$  : Horizontal (yaw) moment due to the steering forces counteracting the above moments (see [2.4.4]).

The above moments are to be assessed for several headings to the wave and wind, typically from  $0^\circ$  to  $180^\circ$  with steps of  $15^\circ$ .

#### 2.4.2 Assessment of horizontal wind moment

The horizontal moment due to the wind is to be assessed based on one of the following method:

- Calculations based on wind coefficients as per NR445, Rules for Offshore units, Part B, Chapter 1, or
- Wind tunnel testing, or
- Computational Fluid Dynamic.

The windage forces are to be assessed based on the windage area with respect to the heading.

The assessment of the positions of the centre of wind resistance and centre of resistance of the immersed hull, in a plane perpendicular to the wind direction, are to be documented.

#### 2.4.3 Assessment of horizontal wave drift moment

The horizontal moment due to the wave drift is to be assessed based on one of the following method:

- Hydrodynamic analysis using a sea-keeping software based on potential flow theory
- Computational Fluid Dynamic
- Model tank test

Full set of numerical results are to be provided.

The software used is to be documented.

When deemed necessary, the Society may require a validation report of the software used.

The positions of the centre of wave drift forces and centre of resistance of the immersed hull, in a plane perpendicular to the wave direction, are to be documented.

#### 2.4.4 Assessment of horizontal steering moment

The assessment of the horizontal steering moment is to be based on a method accepted by the Society.

Intermediate results are to be provided: minimum vessel speed, rudder forces, thruster forces (if any), and position of centre of hull resistance.

The contribution of the rudder(s) and auxiliary thruster(s), if any, for every failure and casualty scenarios defined in [3.2], is to be taken into account considering the possible loss of propulsion power or steering equipment.

## 3 Requirements for duplicated propulsion and steering systems

### 3.1 Principles

**3.1.1** Ships having the additional class notation **HEADING CONTROL-DS** are to be fitted with:

- at least two steering systems, as defined in [3.3], so designed and arranged that, in case of any failure as defined in [1.2.7] affecting such systems or their auxiliary services, there remain sufficient heading control capability to head the ship to the waves, as defined in [1.2.1]

- at least two main propulsion systems, as defined in [3.3.3] are to be fitted

Note 1: This requirement may be waived when others means than main propulsion system are used for heading control, e.g. azimuth thrusters (see [3.3.1]).

- duplicated propulsion auxiliary systems and steering auxiliary systems as defined in [3.4] and [3.5]
- electrical installations and automation system, as defined in [3.6] and [3.7], so designed that in case of any failure as defined in [1.2.7] there remains enough electrical power to maintain simultaneously:
  - sufficient heading control capability to head the ship to the waves, as defined in [1.2.1]
  - the availability of safety systems.

**3.1.2** The loss of one compartment due to fire or flooding is not to be considered as a failure for assignment of the additional class notation **HEADING CONTROL-DS**. Accordingly, the propulsion systems and/or their auxiliary systems or components thereof may be installed in the same compartment. This also applies to the steering systems and the electrical power plant.

**3.1.3** Compliance with requirements [3.1.1] above is to be demonstrated by a risk analysis.

## 3.2 Failure and casualty scenarios

**3.2.1** The description of the failure and casualty scenarios based on the results of the risk analysis are to be submitted. The description is to include the loss of one propulsion system, one rudder system, one electrical generator, one thruster system and a calculation of the remaining power and thrust force in order to assess the steering moment as defined in [2.4.4].

## 3.3 Propulsion and steering systems

**3.3.1** The propulsion and steering machinery is to consist of at least two mechanically independent propulsion and at least two mechanically independent steering systems so arranged that, in case one propulsion or steering system becomes inoperative due to a system failure, the ship will remain able to keep its heading to the waves, as defined in [1.2.1], with the following assumptions:

- adverse weather conditions as defined in [2.2]
- loading conditions as defined in [2.3].

When fitted, an azimuthal thruster may replace one of the propulsion systems and one of the steering systems required above.

**3.3.2** The auxiliary systems serving the propulsion may have common components, be arranged for possible interconnection or serve other systems on board the ship provided that in case of any single failure affecting those systems, not more than one propulsion or steering system is disabled. This is to be substantiated by the risk analysis.

**3.3.3** In case a propulsion system becomes inoperative due to a failure as indicated in [1.2.7], the following conditions are to be satisfied:

- other propulsion/steering systems that were in operation before the failure are not to be affected by the failure. In particular there should be no significant modification of the power or rotational speed of the concerned prime mover
- other propulsion/steering systems that were not in operation before the failure are to be maintained available (heating and prelubrication) and able to be started within 45 seconds after the failure
- safety precaution for the failed propulsion system are to be taken, such as shaft blocking.

This is to be demonstrated during the sea trials.

**3.3.4** The steering systems are to be so designed and arranged that in case of any failure, as defined in [1.2.7], in the systems or in the associated auxiliary systems (cooling systems, electrical power supply, control system, etc.) not more than one steering system is disabled, thus allowing the steering capability to be continuously maintained. This is to be substantiated by the risk analysis.

## 3.4 Propulsion auxiliary systems

### 3.4.1 Oil fuel storage and transfer systems

At least two storage tanks for each type of fuel used by the propulsion engines and the generating sets are to be provided. Means and procedures are to be provided to periodically equalize the content on each storage tank and on each service tank during the consumption of the fuel.

## 3.5 Steering systems

### 3.5.1 Synchronising system

The steering capability of the ship is to be maintained in case of failure of the synchronising system required by the Rules, Pt C, Ch 1, Sec 11, [3.2], without stopping.

## 3.6 Electrical installations

**3.6.1** Single failure leading to the loss of more than one generating set at one time may be accepted, provided the FMEA demonstrates that, after the failure, enough power still remains available to operate the ship under the conditions stated in [3.3.1].

The recourse to the capacity of emergency source is not to be considered.

**3.6.2** The main switchboard is to be automatically separable in two sections. The switchboard is to be arranged with all circuits properly distributed between these sections.

Where a failure occurs on one section of the main switchboard, the remaining section is to be able to supply the services defined in [1.2.2] to [1.2.6].

### 3.7 Automation

**3.7.1** The automation system is to be arranged in such a way that a single failure of the control system may lead to the loss of one steering system only.

## 4 Requirements for independent propulsion and steering systems

### 4.1 General design requirements

**4.1.1** In addition to the requirements set in [3], ships assigned with the notation **HEADING CONTROL-IS** are to comply with this Article.

**4.1.2** In the event of fire or flooding casualty in a machinery space, the propulsion, steering and power generation capabilities are to remain sufficient to maintain the heading control of the ship head to the wave as defined in [1.2.1].

**4.1.3** Fire and flooding casualties are to be considered in machinery spaces or any space containing a component of a propulsion system, auxiliary propulsion system, steering system and auxiliary steering systems, as defined in requirements [1.2.2] to [1.2.5].

Fire and flooding casualties are to be limited to a single space.

**4.1.4** Compliance with requirements above is to be demonstrated by a risk analysis.

### 4.2 Propulsion and steering systems

**4.2.1** Where a propulsion or steering system becomes inoperative due to a fire or flooding casualty, other propulsion and steering systems are not to be affected by the casualty.

**4.2.2** The two independent propulsion and steering systems required in [3.3] are to be located in separate compartments.

**4.2.3** The auxiliary systems serving the propulsion or steering systems may have common components, be arranged for possible interconnection or serve other systems on board the ship provided that in case of any single failure or fire or flooding casualty affecting those systems, not more than one propulsion or steering system is disabled. This is to be substantiated by the risk analysis.

### 4.3 Electrical installations

**4.3.1** Electrical power plant, including main distribution system is to be arranged in separate compartments, so that in case of fire or flooding casualty, the electrical power necessary to supply the systems defined in [1.2.2] to [1.2.6] remain available.

**4.3.2** Single failure and fire and flooding casualties leading to the loss of more than one generating set at one time may be accepted, provided the FMEA demonstrates that, after the failure, enough power still remains available to operate the ship under the conditions stated in [3.3.1] and [3.3.2].

The recourse to the capacity of emergency source is not to be considered.

**4.3.3** The main switchboard is to be automatically separable in two sections distributed in independent spaces separated by watertight and A60 fire resistant bulkheads. The switchboard is to be arranged with all circuits properly distributed between these sections.

Where a failure occurs on one section of the main switchboard, the remaining section is to be able to supply the services indicated in [1.2.2] to [1.2.6].

### 4.4 Automation

**4.4.1** The automation system is to be arranged in such a way that a single failure of the control system, including fire and flooding casualty, may lead to the loss of one steering system only.

**4.4.2** Control stations of propulsion and steering system are to be arranged so that, in case of fire or flooding casualty, the control is still available.

### 4.5 Compartment arrangement

**4.5.1** Separation bulkhead between machinery compartments is to be A60.

**4.5.2** The separation bulkhead between two compartments are to be designed so as to withstand the maximum water level expected after flooding.

**4.5.3** The machinery control room is to be separated from all machinery spaces by A60 bulkhead.

**4.5.4** The main switchboard is not to be located in the control room.

### 4.6 Propulsion auxiliary systems

#### 4.6.1 Oil fuel service tanks and supply lines

Oil fuel service tanks are to be located in separate spaces and means and procedures are to be provided to periodically equalize their content during the consumption of the fuel.

Oil fuel supply from each service tank to the propulsion machinery and to the electrical power plant is to be ensured by two separate lines.



#### 4.6.2 Oil fuel units

Oil fuel units serving the propulsion machinery and the electric power plant are to be distributed in two separate spaces so that in case of fire in one of those spaces, the heading capability criteria set in [2.4].

#### 4.6.3 Oil fuel purifying system

Where duplicated oil purifiers are required by the rules, they are to be distributed in two separate spaces.

### 4.7 Ventilation system

**4.7.1** The ventilation system is to be so designed and arranged that in case of fire in one machinery space accompanied with ventilation stopping, the ventilation is to remain operative in other spaces, so that the availability criteria set out in [4.1.2] are satisfied.

## 5 Tests on board

### 5.1 Operating tests

**5.1.1** Each propulsion systems, steering system as well as the power generation plant are to be subjected to the tests required by the Rules.

### 5.2 Sea trials

**5.2.1** The propulsion machinery, steering machinery and the power generation plant are to undergo the following tests during the sea trials:

- tests required by the risk analysis conclusions and, where deemed necessary, simulation of certain single failures
- the values of the power and speed developed by the propulsion prime movers under test are to be recorded, as well as the electrical consumption
- the starting of the stand-by propulsion system after a failure as defined in [3.3.3]
- Tests with steering system out of service.

## SECTION 29

## ELECTRIC HYBRID PREPARED

### 1 General

#### 1.1 Application

**1.1.1** The additional class notation **ELECTRIC HYBRID PREPARED** may be assigned, in accordance with Pt A, Ch 1, Sec 2, [6.14.45], to new ships that are designed with specific arrangements intended to accommodate an Electric Hybrid installation in the future.

**1.1.2** The additional class notation **ELECTRIC HYBRID PREPARED** gives the opportunity to the ship owner to delay the installation on board of the batteries and their associated equipment in order to anticipate new developments in battery technologies and as a consequence, to take benefit of their last improvements in terms of discharge rates, power density, safety, life cycle, cost, in view of future conversion to electric hybrid as defined in [1.1.3].

The pieces of equipment intended for conversion to electric hybrid need not be provided onboard at newbuilding stage. The additional class notation **ELECTRIC HYBRID PREPARED** aims at controlling the impact of the conversion to electric hybrid on the existing installation by taking into account the corresponding main design requirements.

**1.1.3** The additional class notation **ELECTRIC HYBRID PREPARED** is to be complemented by one or by a combination of the following complementary notations:

- **PM** when at least one of the following Power Management mode is intended to be available:
  - load smoothing mode
  - peak shaving mode
  - enhanced dynamic mode,
 as defined in Ch 11, Sec 22, [1.3.3].

- **PB** when Power Backup mode, as defined in Ch 11, Sec 22, [1.3.4], is intended to be available.
- **ZE** when Zero Emission mode, as defined in Ch 11, Sec 22, [1.3.5], is intended to be available.

#### 1.1.4 Electrical equipment already installed

When electrical equipment within the scope of the additional class notation **ELECTRIC HYBRID** are already installed at newbuilding stage, the requirements defined in Ch 11, Sec 22 are to be complied with.

### 1.2 Definitions and abbreviations

**1.2.1** ESS - Energy Storage System as defined in Ch 11, Sec 22, [1.3.1].

**1.2.2** ECS - Energy Control System as defined in Ch 11, Sec 22, [1.3.2].

**1.2.3** An electric hybrid installation typically includes:

- batteries
- converters
- transformers
- cables & cable trays
- switchboards.

### 1.3 Documents to be submitted

**1.3.1** The documents to be submitted are listed in Tab 1.

**Table 1 : Document to be submitted**

No.	I/A (1)	Documents
1	I	General description of the future installation, with the different "Electric Hybrid" modes
2	I	General arrangement drawing of the ship showing the Electric hybrid installation, either fitted at the newbuilding stage or planned at a subsequent stage (2)
3	I	Power balance expected in the different "Electric Hybrid" modes
4	A	Power balance with ESS in charging mode
5	A	Dimensioning Analysis
6	I	Feasibility and Impact analysis
7	A	Failure Mode and Effect Analysis (FMEA) regarding the availability of ship propulsion and main electrical source of power
<p>(1) I = to be submitted for information. A = to be submitted for approval.</p> <p>(2) The equipment and systems installed at the newbuilding stage and those intended to be installed at a subsequent stage are to be clearly identified on the drawing.</p>		

### 1.3.2 Dimensioning analysis

The dimensioning analysis:

- specifies the dimensioning of the components of the electric hybrid installation already installed and those to be installed in the future for conversion to electric hybrid; and
- justifies the dimensioning of the electrical components of the ship (bus bars, cables, etc.) and the selection of the protections (short circuit current) which will be impacted by the conversion to electric hybrid
- specifies and justifies the spaces and volumes necessary for the installation the future pieces of equipment, to be taken into account in the initial design of the ship, see [4.2]
- specifies the following elements for overall review of the decks supporting the equipment:
  - the design pressures considered on the decks where related equipment will be installed at conversion stage
  - the anticipated maximum weight of equipment together with their expected location and minimum surface projected on deck

This document is to be submitted to the Society for approval.

### 1.3.3 Feasibility and impact analysis

The feasibility and impact analysis is a document which describes the next steps to be followed in order to convert the ship to electric hybrid. This document is to contain the following information:

- list of the main electrical devices or equipment scheduled to be installed for conversion to electric hybrid, for instance, the semiconductor converter, the transformer, the Energy Control System (ECS), the cable trays, the cables
- for each equipment, the design specification and any restriction or limitation to be taken into account for the selection and installation of the future equipment is to be clearly specified, in accordance with [2]
- overall diagram of the electric hybrid, detailing:
  - the pieces of equipment already installed
  - the future installations
  - the interconnection and interfaces between above installations
- drawing showing the foreseen routing of the cables
- the procedure for future installation, considering the practical impact on the ship, detailing foreseen necessary conversion work (such as, for instance, dismantling of ceilings or hull opening)
- identified restrictions or limitations in the installation of the ship which may appear at the time of the conversion to electric hybrid.

This document is to be submitted to the Society for information.

## 1.4 Conversion to electric hybrid

**1.4.1** The conversion to electric hybrid corresponds to the actual installation onboard of all the pieces of equipment required to have a fully operational electric hybrid installation.

**1.4.2** The installation is to be in compliance with the applicable requirements of the **ELECTRIC HYBRID** notation set out in Ch 11, Sec 22, as applicable at the date of conversion.

Each equipment is to be in compliance with the applicable Rule requirements at the time of its actual installation onboard.

Note 1: In case the **ELECTRIC HYBRID** notation is requested with complementary notations different from the complementary notations considered when granting the **ELECTRIC HYBRID PREPARED** notation - e.g. **ELECTRIC HYBRID PM PB ZE** foreseen while **ELECTRIC HYBRID PREPARED PM ZE** was initially granted - the installation is to be in line with all the requirements from Ch 11, Sec 22 associated with the added complementary notations.

**1.4.3** After conversion to electric hybrid, the additional class notation **ELECTRIC HYBRID PREPARED** will be replaced by the additional class notation **ELECTRIC HYBRID**, provided that all the applicable requirements are complied with, see Pt A, Ch 1, Sec 2, [6.14.40].

### 1.4.4 Documents to be submitted when requesting additional class notation **ELECTRIC HYBRID**

a) When conversion to electric hybrid is foreseen, all documents required in Ch 11, Sec 22 are to be submitted in order to request the additional class notation **ELECTRIC HYBRID**.

Alternatively, the following set of documents may be submitted:

- all documents already submitted for obtaining the **ELECTRIC HYBRID PREPARED** additional class notation. These documents are to be updated taking into account the actual installation. In addition, a gap analysis highlighting the changes with respect to the original revision is to be submitted
- list of alarms and defaults. This list is to describe alarms and defaults directly connected to the battery system and interfaces with other ship systems
- detailed specification of the ESS, with its operating manual
- test programs related to type approval, factory test and onboard tests including the standards used for design and testing procedures (for equipment which have not yet been tested)
- reports related to test programs for type approval, factory test and onboard tests (for equipment which have not yet been tested)
- maintenance manual and maintenance schedule
- FMEA required in [2.1.5]. This document is to be updated to take into account the actual design options taken at the conversion stage (detailed design, technology, installation);

b) In addition, the following elements are to be submitted for review of the stability and of the local strength of existing decks and added equipment foundations and reinforcements:

- detail of integration of the equipment
- list of weights and the centre of gravity (longitudinal, transversal and vertical) of all the equipment which will be fitted onboard at their final location.

## 2 System design

### 2.1 Ship design

**2.1.1** One spare incoming feeder is to be provided in the main switchboard for each foreseen connection between the ESS and the main switchboard.

Note 1: These spare incoming feeders are not required to be equipped (for instance with a circuit breaker, protection relay). However, spare spaces are to be available in the main switchboard.

**2.1.2** A sufficient number of spare I/O modules is to be provided into the control alarm and monitoring system of the ship to allow all the foreseen connections of the ECS and of the alarms and controls of the ESS required in Ch 11, Sec 22, Tab 2.

Note 1: No programming nor configuration of the control alarm and monitoring system is required when granting the **ELECTRIC HYBRID PREPARED** notation.

**2.1.3** An electrical load balance including batteries charging mode is to be submitted for information. The maximum predictive battery charging current is to be taken into account.

**2.1.4** The short circuit calculation of the ship is to take into account the prospective short circuit current coming from the ESS.

**2.1.5** A Failure Mode and Effects Analysis (FMEA), as required in Ch 11, Sec 22, [2.2.5], is to be carried out. This document is to be based on the information already available concerning the electric hybrid installation and will have to be completed at the conversion stage. At least, it is to cover the risks coming from the locations foreseen for the different ESS components and is to demonstrate the availability of ship propulsion and main electrical source of power in case of failure of the ESS.

### 2.2 Cables

**2.2.1** The characteristics of the cables used in the dimensioning analysis are to be specified. Cable characteristics include: voltage class, temperature class, insulation material characteristics, number of cores, conductor cross section (mm<sup>2</sup>), special properties (flame retardant/fire resistant, etc).

**2.2.2** Cables hypothesis are to fulfil the provisional load balance in the different Hybrid Electric modes (PM, PB, ZE).

## 3 Electric energy storage system (ESS)

### 3.1 ESS Batteries

**3.1.1** The following design parameters of the batteries intended to be installed at conversion to electric hybrid stage are to be specified in the dimensioning analysis:

- technology
- nominal voltage
- nominal capacity
- discharging rates (C rate): Continuous Discharge Current, Pulse Discharge Current corresponding to the installation in the different modes (PB, ZE)
- autonomy in the different modes (PB, ZE).

**3.1.2** When all the parameters required in [3.1.1] are not yet defined (for instance because new developments in battery technologies are anticipated and installed battery power may be more important), battery parameters hypothesis are to be specified and used in the dimensioning analysis.

**3.1.3** The specified battery parameters are to fulfil the applicable requirements in Ch 11, Sec 22 for the provisional load balance in the different Electric Hybrid modes (PM, PB, ZE).

### 3.2 ESS semiconductor converter and transformer

**3.2.1** The design parameters of ESS semiconductor converter and transformer are to be specified in the dimensioning analysis. It includes nominal power, voltage, technology and service factor if any.

**3.2.2** ESS semiconductor converters and transformer are to fulfil the provisional load balance in the different Hybrid Electric modes (PM, PB, ZE).

### 3.3 ESS Control and instrumentation

**3.3.1** The integration of the ECS of the ESS into the control alarm and monitoring system of the ship is to be anticipated. Foreseen interfaces and their technologies are to be described in the feasibility and impact analysis, see [1.2.3]. This includes the connection of the ECS to the PMS and the connections of alarms and controls required in Ch 11, Sec 22, Tab 2.

## 4 Installation on board

### 4.1 Spaces

**4.1.1** Spaces are to be allocated for the equipment to be installed later within the scope of the **ELECTRIC HYBRID** additional class notation.

**4.1.2** The volumes of these spaces are to be justified. For devices in constant evolution (for instance batteries where energy density increases significantly), the volume allocated will be based on the current state of the art.

Calculation and justification of the volume needed is to be detailed in the feasibility and impact study, see [1.2.3].

**4.1.3** The battery room is to be in accordance with Ch 11, Sec 21, [3.1]. In particular, ventilation, fire boundaries and fixed fire-extinguishing system are to be installed.

**4.1.4** When water cooled components are intended to be installed (batteries, converter, transformer), a connection to the water cooling circuit is to be provided into or close to the rooms where they are installed.

**4.1.5** When the spaces intended for later installation of **ELECTRIC HYBRID** related equipment are used for another purpose (for instance, storage) before the ship is effectively converted to electric hybrid, they are to fulfil the corresponding requirements for this specific use as required by Part C, Chapter 4, or other Rules as applicable.

## 5 Testing

### 5.1 Factory acceptance tests

**5.1.1** Each individual component already installed is to be tested separately according to the requirements of Part C, Chapter 2 or Ch 11, Sec 21 as relevant or other Rules as applicable.

For instance:

- ESS battery pack, see Ch 11, Sec 21, [5]
- ESS semiconductor converter, see Pt C, Ch 2, Sec 6, [3]
- ESS transformer, see Pt C, Ch 2, Sec 5, [2].

### 5.2 On-board tests

**5.2.1** On-board test is to be performed at the conversion to electric hybrid stage, when all equipment are installed and connected, in line with the requirements of Ch 11, Sec 22, [5.2].

## SECTION 30

# ENHANCED CARGO FIRE PROTECTION FOR CONTAINER SHIPS (ECFP)

## 1 General

### 1.1 Application

**1.1.1** This Section applies to ships fitted with equipment, systems and arrangements improving the ability to manage a container cargo fire.

Ships complying with the requirements of this Section may be granted one of the following additional class notations:

- **ECFP-1** when the ship is fitted with portable equipment and arrangements, as per Article [2], that may be considered as retrofit for an existing ship
- **ECFP-2** when, in addition to the requirements for the notation **ECFP-1**, the ship is fitted with equipment, systems and arrangements, as per Article [3], which constitute an extensive set of mitigation measures which are deemed effective and available with standard technologies
- **ECFP-3** when, in addition to the requirements for the above-mentioned notations, the ship is fitted with equipment, systems and arrangements as per Article [4], which include measures that are deemed relevant using innovative technologies.

In general, the additional class notations **ECFP-1**, **ECFP-2** or **ECFP-3** may be granted to ships assigned with the service notation **container ship**.

In general, the additional class notation **ECFP-1** may also be granted to ships having the additional service feature - **equipped for the carriage of containers**.

Tab 1 details equipment, systems and arrangements to be considered for the assignment of notations **ECFP-1**, **ECFP-2** and **ECFP-3**.

**1.1.2** The additional class notations **ECFP-2** and **ECFP-3** are to be completed by the notation (**Area 1, X<sub>1m</sub>; ...; Area n, X<sub>n</sub>m**), where:

- **Area n** indicates the cargo holds where the maximum flooding level **X<sub>n</sub>** is allowed
- **X<sub>n</sub>** corresponds to the maximum flooding level in area n, in meters, with respect to the bottom of the hold (see [3.7]).

Examples:

**ECFP-2(All cargo holds, 20m)**

**ECFP-3(Holds 1 to 4,16m; Holds 5 to 8, 20m; Holds 9 to 12, 15m)**

### 1.2 Innovative technologies

**1.2.1** Special consideration may be given to innovative technologies which would be proposed in lieu of, or as an improvement of, the systems required by this Section, especially regarding:

- fire detection, see [4.3]
- cargo hold fire protection, see [3.6.1].

### 1.3 Documents to be submitted

**1.3.1** The documents listed in Tab 2 are to be submitted.

**Table 1 : Applicable requirements for granting ECFP notations**

Item	Additional class notation		
	ECFP-1	ECFP-2	ECFP-3
Water mist lances	[2.2.1]		
Portable fire-fighting devices for stacked containers (1)	[2.2.2]		[4.2.1]
Fire fighter's outfits	[2.2.3]		[4.2.2]
Equipment for fire patrols	[2.2.4]		
Compressed air system for breathing apparatus	[2.3]		
Fire detection system (1)	–	[3.3]	[4.3]
Water supply	–	[3.4]	
Fixed water monitors covering the on-deck cargo stowage area (1)	–	[3.5]	
Water spray system below hatch cover (1)	–	[3.6]	
Flooding system for the cargo hold (1)	–	[3.7]	
Water-spray system for the protection of the superstructure block (1)	–	[3.8]	
Ventilation (1)	–	[3.9]	
(1) For onboard tests, reference is made to [5.2]			

**Table 2 : Documentation to be submitted**

No	I/A (1)	Document
1	I	General arrangement showing the disposition of all fire-fighting equipment
2	A	Natural and mechanical ventilation systems showing the location of dampers, means of closing, arrangements of fans or air conditioning rooms
3	A	Automatic fire detection systems and manually operated call points
4	A	Fire pumps and fire main including pump's head and capacity, hydrant and hose locations
5	A	Arrangement of the water-based systems required by [3.6], [3.7], [3.5] and [3.8] (2)
6	A	Details of the water monitors, including their capacity, range and trajectory of delivery
7	A	Plan of the water monitor seating arrangements
8	A	Diagram of control systems for the water-based systems required by [3.6], [3.7], [3.5] and [3.8]
9	I	Operating manuals for the water-based systems required by [3.6], [3.7], [3.5] and [3.8]
10	A	Fire control plan
11	I	Cargo hold flooding control booklet as detailed in [3.7.12]
<p>(1) A : to be submitted for approval I : to be submitted for information</p> <p>(2) Plans are to be schematic and functional and to contain all information necessary for their correct interpretation and verification such as:</p> <ul style="list-style-type: none"> <li>• service pressures</li> <li>• capacity and head of pumps and compressors, if any</li> <li>• materials and dimensions of piping and associated fittings</li> <li>• volumes of protected spaces, for gas and foam fire-extinguishing systems</li> <li>• surface areas of protected zones for automatic sprinkler and pressure water-spraying, low expansion foam and powder fire-extinguishing systems</li> <li>• capacity, in volume and/or in mass, of vessels or bottles containing the extinguishing media or propelling gases, for gas, automatic sprinkler, foam and powder fire-extinguishing systems</li> <li>• type, number and location of nozzles of extinguishing media for gas, automatic sprinkler, pressure water-spraying, foam and powder fire-extinguishing systems.</li> </ul> <p>All or part of the information may be provided, instead of on the above plans, in suitable operation manuals or in specifications of the systems.</p>		

## 2 Ships granted with the notation ECFP-1

### 2.1 General

**2.1.1** Ships granted with the notation **ECFP-1** are to comply with the requirements of [2.2] and [2.3].

### 2.2 Portable equipment

#### 2.2.1 Water mist lances

The ship is to be provided with a water mist lance complying with the requirements of Pt C, Ch 4, Sec 6, [6.3.1].

#### 2.2.2 Portable fire-fighting device for stacked containers

In addition to the water mist lance required in [2.2.1], the ship is to be provided with a portable fire-extinguishing device of a type approved by the Society, capable to reach the highest level of containers or the 5th tier of containers above the upper lashing bridge, whichever is the lowest. This device is to be able to pierce the wall of a standard container and of spraying water inside the container when connected to the fire main and raised at this level.

#### 2.2.3 Fire-fighter's outfits

At least 6 fire-fighter's outfits are to be provided onboard. Two spare charges are to be available for each breathing apparatus.

#### 2.2.4 Equipment for fire patrols

A portable thermal imaging camera is to be available onboard.

### 2.3 Compressed air system for breathing apparatuses

**2.3.1** The ship is to be equipped with at least two breathing air compressors supplied from the main and emergency switchboard, or independently driven, complete with all fittings necessary for refilling the bottles of air breathing apparatuses. The compressors are to be located in at least two sheltered and widely separated locations.

**2.3.2** The aggregate capacity of the compressors is to be sufficient to allow the refilling of 2 bottles for air breathing apparatuses in no more than 10min.

**2.3.3** The air suction of the compressors are to be fitted with a suitable filter. The deliveries of the compressors are to be fitted with oil separators and filters capable of preventing passage of oil droplets or vapours to the air bottles.

### 3 Additional requirements for ships granted with the notation ECFP-2

#### 3.1 General

**3.1.1** In addition to the requirements of Article [2], ships granted with the notation **ECFP-2** are to comply with the requirements of [3.2] to [3.9].

#### 3.2 Central control station

**3.2.1** Control and monitoring functions for the safety systems required in this article are to be grouped in a continuously manned central control station as summarized in Tab 3. The continuously manned central control station, as defined in Pt C, Ch 4, Sec 1, [3.15.1], may be the wheelhouse or a dedicated fire control station continuously manned by a responsible member of the crew.

#### 3.3 Fire detection

##### 3.3.1 Fire detection in cargo holds

Under deck cargo holds are to be fitted with either a fixed fire detection and fire alarm system or a sample extraction smoke detection system complying with the requirements of Pt C, Ch 4, Sec 15.

#### 3.4 Water supply systems

##### 3.4.1 General system design

This requirement applies to the systems specified in [3.5] to [3.8].

Pipes are to be designed and manufactured according to the requirements of Pt C, Ch 1, Sec 10.

Steel pipes are to be protected against corrosion, both internally and externally, by means of galvanising or equivalent method.

Suitable drainage cocks are to be arranged and precautions are to be taken in order to prevent clogging of spray nozzles by impurities contained in pipes, nozzles, valves and pumps.

##### 3.4.2 Arrangement of the fire main

The fire main is to be arranged as a ring main laid to the port and starboard side with isolation valves installed at regular intervals. As a minimum it is to be possible to isolate the following sections from the rest of the fire main:

- Sections of the fire main serving accommodation, machinery, service spaces and control stations located in each superstructure block or in the forecabin
- Sections of the fire main serving cargo holds and cargo stowage areas on deck located aft of superstructure blocks, between two superstructure blocks or forward of the superstructure blocks.

Isolation valves are to be steel globe valves or fire safe butterfly valves.

Arrangements are to be made to ensure immediate availability of a supply of water from the fire main at the required pressure either by permanent pressurization or by suitably placed remote arrangements for the fire pumps.

The quantity of water delivered is to be capable of supplying four nozzles of a size and at pressures as specified in Pt C, Ch 4, Sec 6, [1.2.6] and Pt C, Ch 4, Sec 6, [1.4.3]. The arrangement of the hydrants and fire hoses is to be such that it is possible to reach any part of the cargo holds and stowage areas on deck when empty with two jets of water not emanating from the same hydrant, one of which is to be from a single length of hose.

**Table 3 : Monitoring and controls required in the continuously manned central control station**

Parameter		Monitoring		Control	Rule reference
		Alarm	Indication		
Fire detection		X	X (Location of detection)	-	[3.3.1], [4.3]
Water-spray below hatch cover	Isolating valves			X	[3.6.2]
	Pump			X	[3.6.2]
	Drainage valves			X	[3.6.9]
Flooding system for the cargo holds	Sea water level in cargo hold	H, HH	X		[3.7.5]
	Isolating valves		X (Position of the valve)	X	[3.7.4]
	Pump			X	[3.7.4]
Water spray for the protection of the superstructure blocks	Valves			X	[3.8.6]
	Pumps			X	[3.8.6]
Ventilation	Ventilation inlet closing device			X	[3.9.1]
	Power ventilation for the container cargo holds			X	[3.9.2]



### 3.4.3 Fire main capacity

The capacity of the fire pump and fire main diameter are to be sufficient for the simultaneous use of the following combinations of systems, whichever is the most demanding:

- a) Combination of:
  - fire main four nozzles as required by [3.4.2], and
  - water-spray system below hatch cover as required by [3.6], if the main water supply to this system is from the fire pumps, and
  - one water monitor as required by [3.5], if the main water supply to this system is from the fire pumps, and
  - superstructure block protection water-spray as required by [3.8], if the main water supply to this system is from the fire pumps.
- b) Combination of:
  - fire main four nozzles as required by [3.4.2], and
  - mobile water monitors required by Pt C, Ch 4, Sec 6, [6.3], and
  - the water mist lance required by [2.2.1] or the portable fire-fighting device for stacked containers required by [2.2.2] or [4.2.1].

### 3.5 Fixed water monitors covering the on-deck cargo stowage area

**3.5.1** A system of fixed water monitors is to be provided onboard in order to protect the cargo stowage area on deck.

**3.5.2** The arrangement, height and length of throw of the monitors is to be such that any point on the top of the container stacks can be reached by the water jet from one monitor, taking into account the maximum height of the container stacks. The monitors are to be located such that the water jet is free from obstacles, including ship's structure and equipment.

Note 1: The length and height of throw of the monitors are to be measured from the monitor position to the mean impact area.

**3.5.3** The capacity of the pump and arrangement of the piping system supplying water to the water monitors is to be sufficient to achieve the full throw of any one monitor.

The system may be fed by the fire pumps provided their capacity is in accordance with [3.4.3].

### 3.5.4 Water supply redundancy

Water supply to the system is to comply with one of the following alternatives

- a) The system is to be fed by the fire pumps and compliance with [3.4.3] is to be ensured; or
- b) The system is to be fed by dedicated pumps and as a backup the main supply line of the system is to be connected to the fire main through a stop valve located as far as possible from the container cargo holds and stowage area on deck; or
- c) The system is to be provided with a redundant means of pumping. The capacity of the redundant means is to be sufficient to compensate for the loss of any single supply pump. Failure of any one component in the power and

control system should not result in a reduction of required pump capacity by more than 50%. Switch over to redundant means of pumping may be manual or automatic.

**3.5.5** Pump and monitor controls are to be available at a single location.

**3.5.6** Water monitors are to be of an approved type and are to be capable of throwing a continuous full water jet without significant pulsations and compacted in such a way as to be concentrated on a limited surface.

Monitors are to be of robust construction and capable of withstanding the reaction forces of the water jet.

**3.5.7** The seatings of the monitors are to be of adequate strength for all modes of operation.

**3.5.8** The strengthening of the structure of the ship, where necessary to withstand the forces imposed by the water monitor system when operating at its maximum capacity in all possible directions of use, is to be considered by the Society on a case-by-case basis.

### 3.5.9 Scuppers

Scuppers are to be fitted so as to ensure that the water is rapidly discharged overboard. Means are to be provided to prevent the blockage of drainage arrangements and any obstruction to the flow of water towards the scuppers, e.g. due to horizontal structures on deck, is to be avoided.

### 3.6 Water-spray system below hatch cover

**3.6.1** Means are to be provided for effectively cooling under-deck cargo holds by at least 20 L/min per square metre of the horizontal area of cargo spaces by a fixed arrangement of spraying nozzles.

Alternatively, equivalent water-mist systems may be considered on a case-by-case basis, based on suitable fire testing, to the satisfaction of the Society.

### 3.6.2 Controls

The valve controls and pump controls necessary to activate the system are to be grouped together in the continuously manned central control station.

**3.6.3** The system supply equipment and piping are to be located outside the protected cargo holds and all power supply components (including cables) are to be installed outside of the protected cargo holds.

**3.6.4** It is to be possible to feed each nozzle in any cargo hold from piping located on either side of the ship. The piping system should be sized in order to ensure the availability of the flows and pressures required for correct performance of the system, considering that water is supplied from both sides.

### 3.6.5 Isolating valves

Isolating valves are to be provided to separate the section of the system located inside each cargo hold from the rest of the system. The isolating valves are to be located outside of the protected cargo hold and capable of remote release.

### 3.6.6 Pump capacity

The capacity of the system water supply is to be sufficient to feed the water-spray in any one cargo hold.

The system may be fed by the fire pumps provided their capacity is in accordance with [3.4.3].

### 3.6.7 Water supply redundancy

Water supply to the system is to comply with one of the following alternatives:

- The system is to be fed by the fire pumps and compliance with [3.4.3] is to be ensured; or
- The system is to be fed by dedicated pumps and as a backup the main supply line of the system is to be connected to the fire main through a stop valve located as far as possible from the container cargo holds and stowage area on deck; or
- The system is to be provided with a redundant means of pumping. The capacity of the redundant means is to be sufficient to compensate for the loss of any single supply pump. Failure of any one component in the power and control system should not result in a reduction of required pump capacity by more than 50%. Switch over to redundant means of pumping may be manual or automatic.

### 3.6.8 International shore connection

An international shore connection as defined in Pt C, Ch 4, Sec 15, [2] is to be available on each side of the ship, allowing quick connection of the water-spray piping to an external water supply.

### 3.6.9 Bilge drainage

The drainage and pumping arrangements are to be such as to prevent the build-up of free surfaces. The drainage system is to be sized to remove no less than 125% of the combined capacity of both the water-spraying system pumps and the required number of fire hose nozzles.

The drainage system valves are to be operated from outside the protected cargo hold at a position in the vicinity of the extinguishing system controls.

Bilge wells are to be of sufficient holding capacity and are to be arranged at the side shell of the ship at a distance from each other of not more than 40m in each watertight compartment.

Bilge wells are to be of sufficient holding capacity and are to be arranged at the side shell of the ship at a distance from each other of not more than 40m in each watertight compartment. If this is not possible, the adverse effect upon stability of the added weight and free surface of water are to be taken into account to the extent deemed necessary by the Society in its approval of the stability information.

For cargo holds where the carriage of dangerous goods of classes 3 (FP < 23°C), 6.1 (liquids) or 8 (liquids) is intended, the drainage arrangements are to comply with the provisions of Pt C, Ch 4, Sec 12, [2.6].

## 3.7 Flooding system for the cargo holds

**3.7.1** Means are to be provided to allow flooding of any one under-deck cargo hold with sea water, up to the maxi-

mum flooding level defined for each cargo hold. A piping connection from the ballast system is acceptable for this purpose.

Note 1: Simultaneous flooding of several cargo holds is not considered.

### 3.7.2 Maximum flooding level

The maximum flooding level in one cargo hold is the maximum allowable water level in this specific hold, and is to comply with the requirements of [3.7.9] to [3.7.11]. The maximum flooding level with respect to the bottom of the hold,  $X_n$ , in m, is to be specified by the Owner or the Designer.

$$X_n = z_{MAWL} - z_{n, \text{Bottom}}$$

where:

$z_{n, \text{Bottom}}$  : Height above the baseline, in m, of the lowest point in cargo hold n

$z_{MAWL}$  : Height above the baseline, in m, of the maximum flooding level in the considered cargo hold

### 3.7.3 Redundancy of water supply

Water supply to the system is to comply with one of the following alternatives:

- The system is to be fed by the fire pumps and compliance with [3.4.3] is to be ensured; or
- The system is to be fed by dedicated pumps and as a backup the main supply line of the system is to be connected to the fire main through a stop valve located as far as possible from the container cargo holds and stowage area on deck; or
- The system is to be provided with a redundant means of pumping. The capacity of the redundant means is to be sufficient to compensate for the loss of any single supply pump. Failure of any one component in the power and control system should not result in a reduction of required pump capacity by more than 50%. Switch over to redundant means of pumping may be manual or automatic; or
- Gravity filling arrangements may be considered on a case-by-case basis.

### 3.7.4 Means of control

Each cargo hold is to be served by one or several isolation valves which are to be located in a safe location outside of the protected hold. It is to be possible to remotely open or close these valves from the continuously manned central control station. In addition, indication of the position of these valves is to be provided at the continuously manned central control station.

The isolation valves are to be of a fail-close design and suitable marking should be provided to ensure that they will not be opened during normal ship operation.

It is to be possible to remotely start the pumps serving this system from the same location.

In case dangerous goods of Class 4.3 are intended to be carried in a cargo hold, an instruction plate is to be provided close to the controls of the system, informing that these cargoes may react with water.

**3.7.5** Indication of the sea water level in the cargo holds is to be available at the continuously manned central control station. High and high high level alarms are to be available at this location, consistent with the maximum flooding level defined in [3.7.2].

### 3.7.6 Drainage

a) Arrangements are to be made to allow drainage of the flooding water to suitable holding tanks. The actual fire-fighting water storage capacity may however be lower than the total volume of water needed to flood any one cargo hold and is to be detailed in the booklet required in [3.7.12].

Ballast tanks may be used as holding tanks for this purpose, provided the requirements of Pt C, Ch 1, Sec 10, [7] are complied with.

b) Removable gratings, screens or other means are to be installed over each drain opening in the cargo holds to prevent debris from blocking the drain. The gratings or screens are to be raised above the deck or installed at an angle to prevent large objects from blocking the drain.

c) For cargo holds where the carriage of dangerous goods of classes 3 (FP < 23°C), 6.1 (liquids) or 8 (liquids) is intended, the drainage arrangements are to comply with the provisions of Pt C, Ch 4 Sec 12 [2.3] and Pt C, Ch 4 Sec 12 [2.6]. Alternatively, provisions for external discharge of the flooding water may be considered.

**3.7.7** The provisions of Pt C, Ch 1, Sec 10, [5.5] for the prevention of progressive flooding are to be applied.

**3.7.8** The total cross-sectional area of the ventilation openings of the cargo holds is not to be less than 1,25 times the cross-sectional area of the pipes that will be used to flood the cargo holds.

### 3.7.9 Loading conditions

a) Loading conditions

The following loading conditions are to be considered:

FH : Loading condition defined in NR625, Ch 4, Sec 8, [4.1] with any one cargo hold flooded up to the maximum flooding level.

BLF : Loading condition defined in NR625, Ch 4, Sec 8, [4.1] under the assumption that the water contained in the cargo hold when flooded has been drained and transferred to the holding tanks detailed in [3.7.6].

b) Still water hull girder loads

The permissible still water vertical bending moment  $M_{SW-CHF-max}$  and  $M_{SW-CHF-min}$  and vertical shear force  $Q_{SW-CHF-max}$  and  $Q_{SW-CHF-min}$  for cargo hold flooding at any longitudinal position are to envelop the maximum and minimum vertical bending moment and shear force in FH and BLF conditions calculated for each of the cargo holds and based on the loading condition defined in NR625, Ch 5, Sec 8, [4.1].

The permeability of the container cargo holds when flooded is to be taken equal to 0,7.

c) Design load scenario

In addition to the requirements of NR625, Ch 4, Sec 7, the design load scenario defined in Tab 4 is to be taken into account for the verification of the hull local scantlings.


**Table 4 : Additional design load scenario for the verification of hull local scantlings**

Load components		Design load scenario
		Cargo hold flooded (A: S)
Hull girder	VBM	$M_{SW-CHF}$
	HBM	–
	VSF	–
	HSF	–
	TM	$M_{SW-t}$
Local loads	$P_{ex}$ Exposed decks / Outer shell / Sides of superstructures and deckhouses	–
	$P_{in}$ Cargo hold boundaries	$P_{hf}$ (1)
	$P_{dk}$ Exposed and non-exposed decks for uniform cargo	–
	$F_u$ Exposed and non-exposed decks for unit cargo	–
<p>(1) The static pressure <math>P_{hf}</math> in kN/m<sup>2</sup>, in a cargo hold flooded for fire-fighting purposes is to be taken as:</p> $P_{hf} = \rho_{SW} g (z_{MAWL} - z)$ without being taken less than 0 where: $z_{MAWL}$ is the height of the maximum flooding level above the baseline, in m, in the considered cargo hold $\rho_{SW}$ is the sea water density to be taken as 1,025 t/m <sup>3</sup>		

**Table 5 : Additional design load set for local scantling check**

Item	Design load set	Load component	Acceptance criteria	Design load scenario / Loading condition
Cargo hold boundaries	FH-1	$P_{in}$	AC-3	Cargo hold flooded

**Table 6 : Additional loading condition for cargo hold and ballast tanks strength check**

Loading condition	Description	Loading pattern	Container loading	Draught	SWBM	SWSF
FH	One cargo hold flooded		Heavy cargo 20' Any cargo hold flooded	$\leq 0,9T_{sc}$	$M_{sw-CHF-min}$	$Q_{sw-CHF}$

### 3.7.10 Structural strength

#### a) Hull girder strength

The hull girder strength is to be checked according to NR625, Ch 5, Sec 1, [3.3], taking into account the following values for the partial safety factors for load combination and permissible stress.

- $\gamma_2 = 2,1$  for bending strength assessment in seagoing operation
- $\gamma_2 = 2,2$  for shear strength assessment in seagoing operation

For this purpose the permissible still water vertical bending moment  $M_{sw-CHF}$  and vertical shear force  $Q_{sw-CHF}$  defined in [3.7.9], item b) are to be combined with permissible torsional still water moment  $M_{sw-t}$  in seagoing condition, without taking into consideration any wave hull girder loads.

#### b) Hull local scantlings

In addition to the requirements of NR625 Ch 6, the local scantlings of the cargo holds and adjacent compartments are to be sufficient to withstand the design load set specified in Tab 5.

#### c) Direct strength analysis

In addition to the requirements of NR625, Chapter 7, cargo hold structural strength analysis is to be carried out in the loading condition detailed in Tab 6. The weight of immersed containers may be reduced by 30% of the buoyancy acting on each container considered empty. The analysis is to verify that stress levels are within the acceptance criteria for yielding and that buckling capability of plates and stiffened panels are within the acceptance criteria for buckling. The AC-3 acceptance criteria are to be applied.

### 3.7.11 Ship stability

The adverse effect upon stability of the added weight and free surface of water created by the flooding of any one cargo hold up to the maximum flooding level is to be taken

into account in the intact stability calculations, at least for the load cases mentioned in [3.7.12].

In addition, a typical situation where the water contained in the cargo hold when flooded up to the maximum allowable water level has been drained and transferred to the holding tanks detailed in [3.7.6] is to be taken into account in the intact and damage stability calculations.

### 3.7.12 Cargo hold flooding control booklet

A dedicated addendum to the loading manual is to be available onboard, covering the cargo hold flooding and later management of the fire-fighting water. This booklet is to include:

- Drawings of the piping, valves and pumps to be used for filling and emptying the holds
- Detailed instructions covering the operations to flood and empty the hold
- Minimum GM / Maximum KG curve for intact stability, for use during transfer of the flooding water from the flooded cargo hold to the holding tanks.

Note 1: This curve is also to be available in the loading instrument.

- Typical sequences covering the flooding of a cargo hold and later transfer of the cargo hold flooding water to the holds defined in [3.7.6]. The typical flooding sequences are to be developed so as not to exceed applicable strength limitations and paying due attention to the flooding rate and deballasting capacity.

### 3.7.13 Loading instrument

The loading instrument is to be able to:

- Perform hull girder strength check according to the requirements of [3.7.10], item a) and taking into account the actual loading of the ship;
- Perform intact and damage stability calculations according to the requirements of [3.7.11]; and
- Indicate the quantity of fire-fighting water that may actually be stored in the holding tanks, taking into account the actual loading of the ship and the requirements of [3.7.10], item a).

### 3.8 Water-spray system for the protection of the superstructure block

**3.8.1** A fixed water-spraying system is to be installed to cover:

- exposed superstructure vertical boundaries facing container stowage areas, except boundaries of the forecastle spaces;
- foundations of the monitors required in [3.5]; and
- exposed lifeboats, liferafts and muster stations facing container stowage areas.

Alternative solutions may be considered on a case-by-case basis by the Society provided it is demonstrated that they provide an equivalent level of protection of the superstructure blocks.

**3.8.2** The system is to be capable of covering the areas mentioned in [3.8.1] with a uniformly distributed water application rate of at least 10 L/min/m<sup>2</sup> for the largest projected horizontal surfaces and 4 L/min/m<sup>2</sup> for vertical surfaces.

The system may be fed by the fire pumps provided their capacity is in accordance with [3.4.3].

#### 3.8.3 Sections

The fixed water-spraying system may be divided into sections so that it is possible to isolate sections covering surfaces which are not exposed to radiant heat.

The pumps of the water-spraying system are to have a capacity sufficient to spray water at the required pressure on all the areas facing either the cargo stowage area located aft or the cargo stowage area located forward of a superstructure block.

#### 3.8.4 Spray nozzles

The number and location of spray nozzles are to be suitable to spread the sprayed water uniformly on areas to be protected.

#### 3.8.5 Water supply redundancy

Water supply to the system is to comply with one of the following alternatives:

- The system is to be fed by the fire pumps and compliance with [3.4.3] is to be ensured; or
- The system is to be fed by dedicated pumps and as a backup the main supply line of the system is to be connected to the fire main through a stop valve located as far as possible from the container cargo holds and stowage area on deck; or
- The system is to be provided with a redundant means of pumping. The capacity of the redundant means is to be sufficient to compensate for the loss of any single supply pump. Failure of any one component in the power and control system should not result in a reduction of required pump capacity by more than 50%. Switch over to redundant means of pumping may be manual or automatic.

#### 3.8.6 Controls

The valve controls and pump controls necessary to activate the system are to be grouped together in the continuously manned central control station.

### 3.9 Design of the ventilation system

#### 3.9.1 Superstructure block

Separate and redundant means of air supply are to be provided for the accommodation spaces and control stations. Air inlets of the sources of supply are to be arranged both at the front and at the aft of the superstructure blocks, so that the risk of both inlets drawing in smoke simultaneously is minimized in the event of a cargo fire. This requirement need not apply to forecastle spaces.

Means of remotely closing each inlet are to be provided at the continuously manned central control station.

Note 1: The purpose of this requirement is to ensure supply of air free of smoke in all cases. Air conditioning need not be maintained in this case.

#### 3.9.2 Ventilation of the cargo holds

The ventilation openings located in the hatch covers are to be provided with quick closing devices.

Power ventilation for the container cargo holds is to be fitted with controls so grouped that all fans serving one cargo hold may be stopped at once from the continuously manned central control station. It is to be possible to close all ventilation openings, except those located in the hatch covers, from the same location.

## 4 Additional requirements for ships granted with the notation ECFP-3

### 4.1 General

**4.1.1** In addition to the requirements of Articles [2] and [3], ships granted with the notation **ECFP-3** are to comply with the requirements of [4.2] and [4.3].

### 4.2 Portable equipment

#### 4.2.1 Portable fire-fighting device for stacked containers

In addition to the requirements of [2.2.2], the portable fire-extinguishing device for stacked containers is to be able to reach the highest tier of containers, and is to be capable of spraying water inside a confined space when connected to the fire main and raised at this level.

#### 4.2.2 Air breathing apparatuses

In addition to the requirements of [2.2.3], four air breathing apparatuses are to be available onboard, with 2 spare charges for each breathing apparatus.

## 4.3 Fire detection

### 4.3.1 Fire detection in cargo holds

Means are to be provided in the cargo holds to detect and locate heating cargo or a cargo fire at an early stage and identify the container or containers where the seat of the fire or exothermal reaction is located. An audible and visual alarm is to be triggered in case:

- The temperature exceeds the temperature setting, i.e. 54°C; or
- At a lower temperature when an abnormal temperature gradient is detected. Spatial and time domain temperature gradients are to be considered.

The alarm is to indicate the location of the concerned container.

For this purpose, linear heat detection coupled with energy flow analysis as specified in [4.3.3] may be used.

Other innovative solutions may also be considered on a case-by-case basis, such as: fiber optics, heat detection system, thermal imaging cameras, video-based fire detection. In this case:

- The efficiency and reliability of the system are to be documented to the satisfaction of the Society
- The system is to comply with the principles detailed in Pt C, Ch 4, Sec 15, [8] as applicable
- The components of the system are to comply with the requirements of Part C, Chapter 3 as applicable and are to be approved according to a recognized standard.

### 4.3.2 Fire detection on deck

Means are to be provided to detect a cargo fire on deck. For this purpose, innovative solutions may be considered, such as: thermal imaging cameras, flame detection systems, video-based fire detection, linear heat detection.

The efficiency and reliability of the system are to be documented to the satisfaction of the Society.

The system is to comply with the applicable requirements of Pt C, Ch 4, Sec 15, [8].

The components of the system are to comply with the requirements of Part C, Chapter 3 as applicable and are to be approved according to a recognized standard.

### 4.3.3 Linear heat detection coupled with energy flow analysis

- The system is to include linear heat detectors the output of which is retrieved and analyzed by an energy flow analysis software at least every 5 seconds.
- Installation
  - Heat detector cables are to be installed, providing one sensor per container as well as supplementary temperature sensors measuring the hull temperature at every container tier level.

Note 1: In case installation on open deck is foreseen, the hull temperature sensors are to be replaced by outside temperature sensors.

- All sensors covering one bay of containers as well as the associated hull or outside temperature sensors are to be sampled synchronously

- The sensors are to be approximately facing the center of the container doors and are not to be further than 200 mm away from the container wall. The sensors are to be thermally insulated from the ship structure.
  - The sensors are to be protected from direct sunlight.
- All the components of the system are to comply with the requirements of Part C, Chapter 3 as applicable.
  - The system is to comply with the applicable requirements of Pt C, Ch 4, Sec 15, [8].
  - The individual sensors are to be approved according to EN54-5 Class A1 and in addition:
    - The standard deviation of the measured values at a constant temperature is to remain below 0,1°C; and
    - The response time of the sensors is to be between 5 and 10 min when submitted to 0,6 K/min rise or air temperature, according to the procedure specified in EN54-5 Clause 5.5.
  - All the data retrieved from the linear heat detectors is to be recorded in a mass storage medium and retained for at least 30 days.

## 5 Certification and testing

### 5.1 Type approval of portable fire-fighting devices for stacked containers

#### 5.1.1 Design requirements

The device is to be capable to drill a hole in a standard steel container door located at the requested height, then spray water in the container.

It is to be possible to connect the device to the ship's fire main through standard hydrants and fire hoses.

The weight of the device in working order is not to exceed 23 kg.

#### 5.1.2 Type testing

The fire-fighting devices for stacked containers are to undergo a type test showing that the device can drill a hole into a standard container door and spray water inside a container stacked at height.

For the purpose of the test:

- A standard container door is to be installed at the testing height. The container door is to consist of at least 2 mm thick weathering steel plating and to be of a design type-approved according to ISO 668 for a 20 ft or 40 ft container.
- A representative specimen of the portable fire-fighting device is to be connected to water supply through a standard fire hose
- The device is then to be raised up to the container door by its lifting and fixation system
- The device is then to be activated and should drill a hole in the container door in less than one minute, then spray water.

The following data are to be recorded:

- Pressure at the hydrant
- Length of throw at the level of the floor of the container corresponding to the pierced door
- Duration of the penetration phase
- Water flow rate during the water-spraying phase.

## 5.2 Onboard tests

### 5.2.1 Fixed fire-fighting systems

After assembly on board, the following systems are to be checked for leakage at normal operating pressure:

- water-spray system below hatch cover as required by [3.6]
- on deck fire-fighting system as required by [3.5]
- superstructure block protection water-spray system as required by [3.8].

The following systems are to undergo an operational test on board the ship, to check their characteristics and performances:

- water-spray system below hatch cover as required by [3.6]. The testing should include verification of the functionality of the drainage arrangements
- on deck fire-fighting system as required by [3.5]
- cargo hold flooding system as required by [3.7]. The testing should include verification of the functionality of

the drainage arrangements and of the high and high level alarm in the cargo hold

- superstructure block protection water-spray system as required by [3.8].

### 5.2.2 Ventilation

The means of remotely closing the superstructure block ventilation inlets and remote control for the cargo hold power ventilation are to be functionally tested.

### 5.2.3 Fixed fire-detection system

The fixed fire detection systems required by [3.3] or [4.3] are to be functionally tested after installation onboard using adequate smoke or heat sources as relevant.

### 5.2.4 Portable fire-fighting devices for stacked containers

The performance of the portable fire-fighting devices for stacked containers is to be demonstrated by an operational test onboard the ship. It is to be checked that:

- the fire-fighting device can be effectively risen and installed at its nominal height
- the required pressure can be delivered from the water main to the fire-fighting device in this configuration, with 4 water jets from other fire hoses and the mobile water monitors operating simultaneously.

## SECTION 31

## BIOLOGICAL RISK MANAGEMENT (BIORISK)

### 1 General

#### 1.1 Application

**1.1.1** This Section applies to ships where measures intended to prevent and manage infectious disease outbreaks on board have been implemented.

Ships complying with the requirements of this Section may be granted one of the following additional class notations:

- **BIORISK MANAGED** when an outbreak management plan has been established and implemented on board the ship, as described in [2].
- **BIORISK SECURED** when, in addition to the requirements applicable for **BIORISK MANAGED**, permanent systems, arrangements and fixed or portable equipment, retained as risk control measures, as required by [3] are provided on board.

#### 1.2 Documents to be submitted

**1.2.1** The documents listed in Tab 1 are to be submitted.

### 2 BIORISK MANAGED

#### 2.1 Biological risk assessment

**2.1.1** A biological risk assessment is to be carried out in order to identify the risks to the crew and passengers with regards to reasonably foreseeable infectious diseases that may occur on board the ship. The risk assessment is to involve medical experts and is to be carried out according to a method from recognized standards accepted by the Society (e.g. ISO 31010), involving a risk identification process as well as the definition of relevant risk control measures covering possible failures at each step of the chain of events (avoid embarking contaminated goods or persons, detection of suspect cases, prevention of further contamination, evacuation or treatment of confirmed cases). The risk assessment is to cover the operations under normal conditions as well as the case of an outbreak developing on board. When relevant the risk control measures are to be commensurate with the current epidemic situation onshore.

**2.1.2** The risk assessment report is to list the guidance documents used to prepare the risk assessment.

Note 1: Guidance documents may include NI 673 "Guidelines for Management of COVID-19 and Infectious Diseases" issued by the Society. Other recognized guidelines may be considered.

**Table 1 : Documents to be submitted**

No.	I/A (1)	Document
Documents to be submitted for the additional class notation <b>BIORISK MANAGED</b>		
1	I	Outbreak Management Plan, including the associated set of procedures, protocols and instructions
2	I	Risk assessment report
3	I	Specification of the type, quantity and storage locations of PPEs
4	I	Signs, posters and marking specification, describing the type and foreseen location of these items
Supplementary documents to be submitted for the additional class notation <b>BIORISK SECURED</b>		
5	I	General arrangement plan showing the location, extent and arrangement of the quarantine area
6	A	Details of the means of monitoring the accesses of the quarantine area required in [3.2.3]
7	A	Details of the means of communication required in [3.2.5]
8	A	Diagram of the natural and mechanical ventilation systems, showing: <ul style="list-style-type: none"> <li>• the location of the inlets and outlets to the quarantine area, other accommodation spaces and normally manned control stations</li> <li>• means for air filtration or disinfection, where provided</li> </ul>
9	A	Details of the means for air filtration or disinfection, where provided, including testing and approval references
10	A	Specification of the means to monitor body temperature required in [3.4.2]
(1) A: To be submitted for approval I: To be submitted for information		



**2.1.3** The adopted risk control measures and provisions are to be described in appropriate documents and implemented on board.

## 2.2 Outbreak Management Plan

**2.2.1** An Outbreak Management Plan describing the measures and procedures applied to prevent and to respond to an outbreak developing on board, is to be established based on the risk assessment required in [2.1]. The documents used as references to define the Plan are to be listed in the Outbreak Management Plan.

**2.2.2** The Outbreak Management Plan and the corresponding procedures are to be permanently available on board.

**2.2.3** In general, at least the following items are expected to be covered in the Outbreak Management Plan, as appropriate and commensurate to the concerned ship:

- description of responsibilities to manage the Outbreak Management Plan
- resources and personnel needed
- means of information and communication, including relevant signage for circulation and crowd management
- conditions for embarkation and disembarkation of crew passengers and other persons
- physical distancing
- personal hygiene, hand washing
- cleaning and disinfection of facilities
- food and other essential supply, storage and distribution
- water supply
- onboard services and supplies
- personal protective equipment
- heating, ventilation and air conditioning systems
- health screening on board
- waste management
- Medical supplies and equipment, including oxygen supplies and storage location
- Areas dedicated to the storage of relevant supplies
- Areas to be dedicated to specific outbreak management operations (e.g. suspected cases isolation, health screening etc.) when such operations are to be carried out.

**2.2.4** The Outbreak Management Plan and the corresponding set of procedures and instructions are to be reviewed and updated by the Owner on a regular basis, as necessary.

**2.2.5** Where risk control measures include specific supplies or non-permanent equipment to be made available on board, their type and description, quantities, availability, locations, as well as provisions for user's training, user's instructions and storage conditions are to be included in the Outbreak Management Plan and documents. They are to be stored on board in properly identified locations.

## 2.3 Personnel Protective Equipment (PPE)

**2.3.1** Personal Protective Equipment are to be available on board, including:

- face mask covering the mouth and nose
- surgical masks
- plastic apron or impermeable gown
- standard, non-sterile gloves, as well as cleaning gloves. Both types are to be available in various sizes.
- goggles or visors.

**2.3.2** The type and quantity of PPEs is to result from the risk assessment and is to be available on board as defined in the Outbreak Management Plan.

## 2.4 Signs and marking

**2.4.1** The following equipment is to be available on board, as defined in the Outbreak Management Plan:

- posters with hygiene and physical distancing recommendations
- circulation and crowd management signage.

The type, quantity and location of those signs and markings are to be as defined in the Outbreak Management Plan.

## 3 Additional requirements for BIORISK SECURED

### 3.1 General

**3.1.1** The additional class notation **BIORISK SECURED** may be assigned to ships complying with the requirements of this article in addition to those defined for the additional class notation **BIORISK MANAGED**.

**3.1.2** Compliance with the requirements of this article may be achieved through a specific configuration of doors, ventilation systems, or other systems, provided this configuration complies with the requirements of Part C, Chapter 4, especially regarding means of escape ( Pt C, Ch 4, Sec 8) and ventilation ( Pt C, Ch 4, Sec 5, [6]), as applicable.

### 3.2 Quarantine area

**3.2.1** A quarantine area is to be arranged, or ready to be arranged, on board, consisting of a number of cabins where infected persons or persons suspected to be infected may be isolated. The size of the quarantine area is to be coherent with the ship operational profile and the procedures set out in the Outbreak Management Plan.

In case the quarantine area is not a permanently arranged area, the Outbreak Management Plan is to include provisions for making the quarantine area available in case of an outbreak.

#### 3.2.2 Ventilation

- a) A mechanical ventilation system of the extraction type, capable of providing at least 10 air changes per hour in each cabin, is to be provided in the quarantine area.

b) The required air flow may be achieved through air recirculation within a given cabin provided:

- air recirculation is done through a filter with a particulate matter efficiency ePM1 of at least 50% according to ISO EN 16890-1 or at least 50% over the 0.3µm - 1µm range; and
- at least 2 fresh air changes per hour are ensured.

c) Exhaust ducts serving spaces in the quarantine area are not to serve any other space outside of the quarantine area.

d) Each space in the quarantine area is to be provided with a dedicated exhaust duct not serving any other space, unless the air is filtrated through a high efficiency particulate air (HEPA) filter realizing a collection efficiency H13 according to EN 1822-1 or a collection efficiency of 99.97% of particles of 0,3 µm or greater.

Alternatively exhaust ducts may serve several spaces in the quarantine area provided the operation of the exhaust fan is monitored and, in the event of failure of the exhaust fan, an audible and visual alarm is given at a continuously manned location. In addition temporary measures such as using certified medical face masks are to be implemented until the system functionality has been restored.

e) Enthalpy wheels may be fitted on such exhaust ducts from the quarantine area provided that:

- the enthalpy wheel is capable of being stopped when the area is used as a quarantine area; and
- it is demonstrated that no air leakage will occur between the supply and the exhaust in this configuration.

f) Exhaust air from the cabins of the quarantine area is to be led directly outside to a location at least 6 m away from areas normally accessible to passengers or crew. This distance is to be measured from the centre of the exhaust outlet. This distance may not be applied provided the air outlet is equipped with a HEPA filter realizing a collection efficiency H13, according to EN 1822-1, or a collection efficiency of 99,97% of particles of 0,3 µm or greater, or with an alternative disinfection system. Documentation supporting the efficiency of the alternative disinfection system is to be submitted to the Society.

### 3.2.3 Access

a) Washing stations are to be provided at each access to the quarantine area with means to wash hands and sufficient room for the storage of clean and soiled materials and for doning medical gowns.

A hydro-alcoholic gel dispenser or a basin with water and soap may be accepted as means to wash hands.

b) Direct access to an open deck or to a side shell door is to be provided from the quarantine area, so that an infected person can be evacuated without entering other parts of the ship.

The corridor serving any cabin in the quarantine area and access therefrom to the open deck or to the side shell door is to have a sufficient width to permit the passage of

the enclosed stretcher and totally enclosed wheelchair required by [3.4.3].

c) Means of monitoring access to the quarantine area are to be provided. An alarm, a CCTV system, or other alternative system covering all accesses to the quarantine area may be accepted for this purpose.

### 3.2.4 Cabin arrangement

a) Each cabin in the quarantine area is to be provided with an individual sanitary unit including at least toilets, a handwash basin and a shower or bathtub.

b) Each cabin in the quarantine area is to have a self-closing door.

### 3.2.5 Means of communication

a) A means for the quarantined person to contact assistance is to be available in each cabin of the quarantine area. Fixed internal telephone, portable devices or other alternative means, may be accepted for this purpose.

b) Means are to be available in each cabin of the quarantine area for the crew or medical staff to check the condition of each quarantined person without entering the cabin. Video monitoring, telephone communication or other alternative means may be considered for this purpose.

## 3.3 Ventilation of accommodation spaces and normally manned control stations

**3.3.1** Supply air for accommodation spaces and normally manned control stations is to be either:

a) Directly taken from the outside, possibly through enthalpy wheels; or

b) Filtrated with a particulate matter efficiency ePM1 of at least 50% according to ISO EN 16890-1 or at least 50% over the 0,3 µm – 1 µm range; or

c) Otherwise disinfected, e.g. through Ultraviolet Germicidal Irradiation (UVGI) or other alternative disinfection system. Documentation supporting the efficiency of the alternative disinfection system is to be submitted to the Society.

**3.3.2** When UVGI system is used, installation in the upper part of the room is not allowed. UVGI lamps may be either incorporated into room air-recirculation units or part of a duct irradiation system. In both cases, the functioning parameters of the system are to be adjusted, taking into account the air flow, in order to provide UV-C rays at the relevant wavelength for the targeted pathogen and sufficient irradiation time to inactivate it.

**3.3.3** Air inlets for accommodation spaces and normally manned control stations are to be located at least 3 m away from air outlets from these spaces or from similar spaces and at least 10 m away from air outlets from the quarantine area. These distances are to be measured from the center of the concerned air inlet or outlet.

These distances may not be applied when the concerned air inlet or outlet is equipped with filters or alternative disinfection system according to [3.3.1] item b) or c).

**3.3.4** In public spaces designed to accommodate more than 50 persons, a mechanical ventilation system capable of providing at least 6 air changes per hour is to be provided. The required air flow may be partially achieved through air recirculation inside the space in accordance with [3.3.1] item b) or item c). Alternatively, a ventilation system capable of providing 4.5 fresh air changes per hour may be accepted.

The ventilation system may be fitted with an air flow regulation system allowing to operate it with a lower rate of air changes when found acceptable according to the Outbreak Management Plan.

### 3.4 Other equipment

#### 3.4.1 Internal communication

A means allowing to organize crew meetings through videoconference is to be available on board. It is to be possible to connect to this system from:

- a) the wheelhouse; and
- b) the engine control room; and
- c) at least one crew public space.

#### 3.4.2 Means to monitor body temperature

Means to monitor the body temperature of the crew and passengers on a regular basis are to be available on board. Either fixed or portable equipment may be accepted for this purpose.

**3.4.3** At least one totally enclosed stretcher and one totally enclosed wheelchair are to be available on board.

## 4 On board testing

### 4.1 Initial survey

**4.1.1** An initial survey is to be carried out on board prior to granting the additional class notation **BIORISK MANAGED** or **BIORISK SECURED**.

**4.1.2** The initial survey is to include:

- a) Verification that the Outbreak Management Plan and associated documents are available on board.
- b) Verification that the PPEs, signs, marking and medical supplies required by the Outbreak Management Plan are available on board.

**4.1.3** In addition to the requirements of [4.1.2], the initial survey for the additional class notation **BIORISK SECURED** is to include:

- a) Functional testing of the ventilation arrangements for the quarantine area, as required by [3.2.2], and for the accommodation spaces and normally manned control stations, as required by [3.3]. It is to be checked that the ventilation system is functioning properly with the air filtration or alternative air disinfection system working.
- b) Functional testing of the means of monitoring the access to the quarantine area.
- c) Verification of availability of the means of communication for the quarantine area.
- d) Functional testing of the means of monitoring body temperature.
- e) Verification of availability of totally enclosed stretcher and totally enclosed wheelchair.

## SECTION 32

## HYBRID MECHANICAL PROPULSION

### Symbols

ESS : Electrical Storage System.

PTI : Power Take In.

PTO : Power Take Off.

### 1 General

#### 1.1 Application

**1.1.1** The additional class notation **HYBRID MECHANICAL PROPULSION** may be assigned in accordance with Pt A, Ch 1, Sec 2, [6.14.49] to ships provided with a propulsion plant which combines a diesel mechanical propulsion system and an electric propulsion system.

**1.1.2** In hybrid propulsion, the diesel mechanical propulsion system and the electric propulsion system may be used separately or together.

Hybrid propulsion configuration offers a higher flexibility and efficiency of the propulsion system, over a range of operating modes, for slow speed operation up to boosting mode.

**1.1.3** In addition to the additional class notation **HYBRID MECHANICAL PROPULSION**, the additional notation **ELECTRIC HYBRID** may be granted to the ship when an ESS is used and the ship complies with the requirements of Ch 11, Sec 22.

#### 1.2 Definitions

##### 1.2.1 PTI Fully electric mode

This mode describes the functionality of an electrical rotating machine used as motor for propulsion and working alone, i.e. with the diesel engine stopped.

##### 1.2.2 PTI Booster mode

This mode describes the functionality of an electrical rotating machine used as motor for propulsion and working in parallel to the diesel propulsion engine.

##### 1.2.3 PTO Mode

This mode describes the functionality of an electrical rotating machine used as a generator. A part of the energy generated in the main engine is taken off by the generator to produce electricity as an alternative to the generating sets. This mode is also called shaft generator mode.

### 1.3 Documents to be submitted

**1.3.1** The documents listed in Tab 1 are to be submitted.

**Table 1 : Documents to be submitted**

No.	I/A (1)	Documents
1	I	General description of the propulsion systems with their different operating modes
2	I	Operation manual of the hybrid propulsion system
3	I	Operating procedure to switch from one propulsion system to an other one
4	A	Power balance in diesel propulsion mode Power balance in PTI fully electric mode Power balance in PTI booster mode, if any
5	A	List of alarms and defaults
(1) A : For approval I : For Information		

### 2 System design

#### 2.1 Propulsion systems

**2.1.1** The propulsion arrangements defined in Fig 1 are accepted. Batteries may be considered instead of diesel generators. Other arrangements may be considered on a case by case basis.

**2.1.2** The following propulsion modes are to be made available:

- diesel propulsion mode
- PTI Fully electric mode.

Note 1: For the purpose of granting the additional class notation **HYBRID MECHANICAL PROPULSION**, the PTI Booster mode is considered as optional.

**2.1.3** As a general principle, the diesel propulsion mode is considered as the main propulsion mode and has priority over the electric propulsion mode.

#### 2.2 Electric Production systems

**2.2.1** If the electric motor can work as a generator, it may be accepted as forming part of the main source of electrical power, provided it complies with Pt C, Ch 2, Sec 3, [2.2.12].

**2.2.2** In PTI fully electric mode and in addition to [2.2.1], it is not required to have a main source of electrical power complying with Pt C, Ch 2, Sec 3, [2], when the rotating machine is reversible and can work in PTI mode or PTO mode (see Fig 2), provided that:

- the main source of electrical power complies with Pt C, Ch 2, Sec 3, [2.2], in diesel propulsion mode; and
- upon loss of power of one generator, the rotating machine used in PTI mode switches automatically to PTO mode and connects to the main switchboard in less than 30 sec.

**2.2.3** Where the number of generators in service is intended to vary according to operating conditions, the installation is to include automatic start, synchronising, connecting and load sharing.

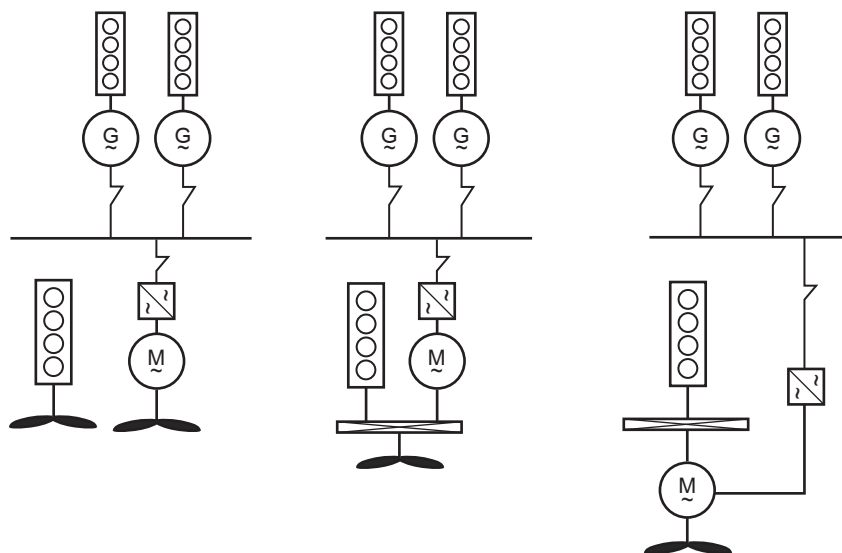
**2.2.4** A longer time than defined in [2.2.2] may be accepted provided that the ship is granted with the additional class notation **ELECTRIC HYBRID (PB)** (see Ch 11, Sec 22). For this particular case, the autonomy of the ESS in PB mode is to be twice the time necessary to switch from electric motor to shaft alternator (see Fig 3).

**2.3 Diesel propulsion systems**

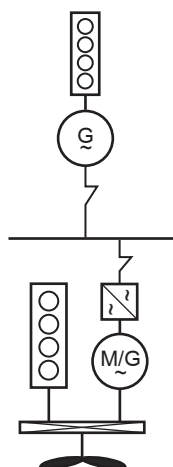
**2.3.1** The diesel propulsion system is to comply with the requirements of:

- Pt C, Ch 1, Sec 2
- Pt C, Ch 1, Sec 9
- the relevant section of Part F, Chapter 3 if an **AUT** additional class notation is to be granted to the ship.

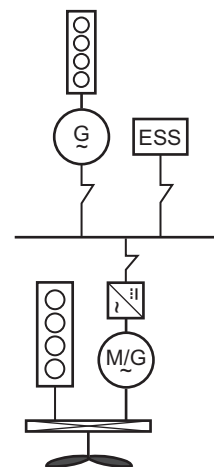
**Figure 1 : Propulsion arrangements**



**Figure 2 : Specific arrangement of electrical production with PTO mode**



**Figure 3 : Electrical production with ESS**



## 2.4 Electrical propulsion systems

**2.4.1** The electric propulsion system is to allow the ship to proceed at a reference speed in the reference weather conditions, taking into account the foreseen operational area and operational profile. Both the reference speed and the reference weather conditions are to be defined by the Owner.

**2.4.2** The electric propulsion system is to comply with Pt C, Ch 2, Sec 14 and the relevant section of Part F, Chapter 3 if an **AUT** additional class notation is to be granted to the ship.

**2.4.3** When compliance with [2.4.2] is not fulfilled, the switch over from the electric propulsion mode to diesel propulsion mode is to be done in less than 45 sec.

In addition, and as a minimum, the electric propulsion is to be in accordance Pt C, Ch 2, Sec 14, [4].

## 2.5 Combined diesel and electric propulsion systems

**2.5.1** In the case of diesel engines and electric motors acting in parallel on the propeller, provisions are to be made to allow isolating the electric motors from the reduction gear (for instance by mean of a clutch or bolted link). In case of failure of the electric motor, it is to be possible to isolate the electric motor from the reduction gear and start the diesel engine in less than 30 minutes.

## 3 Control of propulsion machinery

### 3.1 Remote control from navigating bridge of the propulsion machinery

**3.1.1** Arrangements are to be made to allow each propulsion mode to be started from the navigating bridge.

**3.1.2** It is to be possible to control separately each propulsion mode (diesel propulsion mode, PTI fully electric mode, PTI booster mode, if any) along all the propulsion power range.

**3.1.3** Functionalities are to be provided in the navigation bridge to set the diesel propulsion engine in stand-by mode (diesel engine started, running, not clutched).

**3.1.4** The type of propulsion in use is to be clearly indicated at each control position.

**3.1.5** The control may be performed by:

- a single lever combining the diesel propulsion mode, PTI fully electric mode, PTI booster mode if any
- two levers, one for the PTI fully electric mode, one for the diesel propulsion mode.

**3.1.6** Emergency stops required in Pt C, Ch 3, Sec 2, [4.2.7] are to be independent and separated for both propulsion systems. Two separate buttons, installed close to each other, are required.

**3.1.7** The propulsion control system is to ensure that the shaft power does not exceed the limit for which it has been designed (see Pt C, Ch 1, Sec 6 to Pt C, Ch 1, Sec 9).

### 3.2 Local control of the propulsion machinery

**3.2.1** The diesel and PTI fully electric modes are to be provided with direct local controls. The direct local control is to be independent from the remote control circuits, and to take over any remote control.

### 3.3 Switch over from one propulsion type mode to another one

**3.3.1** The switch over from one propulsion to the other one is to be feasible from the navigation bridge. It is not to necessitate any human intervention in the machinery.

**3.3.2** The switch over is to require a limited number of actions on the control system. Starting of the auxiliaries necessary for each propulsion mode (cooling, lubricating, etc...) is to be automatic.

When transferring the propulsion mode from one type to an other one (for instance from diesel mode to PTI fully electric mode), no significant alteration of the propeller thrust is to occur.

**3.3.3** When only 1 lever is used to control the propulsion, the propulsion mode is to switch automatically from PTI fully electric mode to diesel propulsion mode when the propulsion power request exceeds the capacity of the PTI fully electric mode.

**3.3.4** When 2 levers are used to control the propulsion, the propulsion mode is to switch automatically from PTI fully electric mode to diesel propulsion mode when the diesel propulsion lever is used.

**3.3.5** It is to be possible to switch manually from one propulsion mode to the other one locally.

**3.3.6** The local control is to have priority over the remote control. The principles of control transfer, as specified in Pt C, Ch 3, Sec 2 are applicable for both propulsion modes.

### 3.4 Displays and alarms

**3.4.1** In addition to the monitoring required in Pt C, Ch 3, Sec 2, the following information is to be displayed at each control position:

- indication that diesel propulsion engine is running
- indication that electric propulsion motor is running
- indication of the diesel engine ready to start
- indication of the electrical motor ready to start
- indication of the diesel engine in "stand-by" mode.

## 4 Testing

### 4.1 Onboard tests

4.1.1 The following propulsion modes are to be tested:

- PTI fully electric propulsion mode and PTI booster mode, if available, according to Pt C, Ch 1, Sec 15, [3.9]
- diesel propulsion mode, according to Pt C, Ch 1, Sec 15, [3.5].

4.1.2 The following tests are to be carried out on the control system:

- a) Proper working of alarms and defaults and related functions and/or interfacing to the other ship systems
- b) Manual switch from diesel propulsion mode to PTI fully electric mode and to PTI booster mode, if available
- c) Manual switch from PTI fully electric propulsion mode and from PTI booster mode, if available, to diesel propulsion mode
- d) Transfer of control between the different control positions
- e) Automatic switch from PTI fully electric propulsion mode to diesel propulsion Mode (see [3.3.3] and [3.3.4]).

## SECTION 33 OPEN-HATCH

### 1 General

#### 1.1 Application

**1.1.1** The additional class notation **OPEN-HATCH** may be assigned, in accordance with Pt A, Ch 1, Sec 2, [6.14.51] to ships granted with the service notation **general cargo ship** and complying with the requirements of the present Section.

**1.1.2** This Section specifies the applicable requirements for general cargo ships intended to undertake sea voyage with one or several hatch covers not in place.

**1.1.3** For any sea voyage undertaken with one or several hatch covers not in place, Administration is to grant an exemption to the International Load Line Convention.

**1.1.4** If there is any conflict between the requirements of this Section and statutory requirements or conditions imposed by the Administration, the latter takes precedence. Refer to Pt A, Ch 1, Sec 1, [4.1.3].

**1.1.5** For ships having the additional service feature **equipped for the carriage of containers**, the stability and fire safety provisions of MSC/Circ.608 are to be considered in addition to the ones defined in the present Section.

#### 1.2 Definitions

##### 1.2.1 Maximum sustained speed

Maximum service speed taking into account speed loss due to resistance increase in regular waves. Voluntary speed loss is not taken into consideration.

##### 1.2.2 Minimum ship manoeuvring speed

Minimum speed which maintains directional control and which is consistent with the operating characteristics of the ship.

##### 1.2.3 Green water

Sea water other than spray shipped aboard the ship under normal operating conditions.

### 2 Freeboard

#### 2.1 General

**2.1.1** Minimum freeboard is to be determined by seakeeping characteristics and stability. The following information, obtained by means of model tests and calculations according to the procedure in Article [5], are to be submitted to the Society for information:

a) measured data for the maximum hourly rate of ingress of green water, in m<sup>3</sup>/hour, likely to be shipped into each cargo hold

b) evaluation of the adequacy of the discharge rates from cargo hold freeing ports (if they are fitted).

**2.1.2** The maximum hourly rate of ingress of green water in any one open hold determined from model testing according to the procedure in Article [5] is not to exceed the hatch opening area  $S$ , in m<sup>2</sup>, multiplied by 0,4 m/hour.

**2.1.3** A conventional geometrical freeboard and minimum bow height are to be calculated assuming that hatch covers are fitted. The freeboard and bow height assigned to the ship is not to be less than the equivalent geometrical freeboard determined from the International Convention on Load Lines, 1966, as amended.

**2.1.4** All seasonal freeboards are to be omitted unless the minimum geometrical freeboard and corresponding seasonal freeboards for which the ship is eligible (assuming hatch covers fitted) are greater than the freeboard for which the model tests were satisfactorily carried out. In that case, the minimum geometrical freeboard and the corresponding seasonal freeboards greater than the freeboard for which the model tests were carried out are to be assigned.

**2.1.5** The minimum freeboard and minimum bow height assigned to the ship are not to be less than those corresponding to the model test conditions.

### 3 Stability

#### 3.1 Intact stability without water ingress

**3.1.1** The stability of the ship in all loading conditions, with no water ingress in the cargo hold, is to meet the requirements of Pt B, Ch 3, Sec 2 considering the top of hatch coamings as downflooding points.

**3.1.2** Where cargo hold freeing ports are fitted, they are to be considered closed for the purpose of determining the flooding angle, provided that the reliable and effective control of closing of these freeing ports is satisfactory to the Society.

#### 3.2 Intact stability considering water ingress

**3.2.1** The factor  $S_{\text{final}}$  calculated according to Pt B, Ch 3, App 3, [1.6.4] for the ship in intact condition, with water trapped in the cargo hold, is not to be less than 1 under the following conditions:

a) The ship in intact condition before water ingress is loaded at maximum draught for open hatch condition taking into account the maximum allowable vertical center of gravity (VCG) resulting from intact and damage stability criteria.



- b) The cargo hold is to be filled with the volume of water  $V$ , in  $m^3$ , accumulated for 3 hours, and taken equal to (considering a cargo hold permeability of 0,95):

$$V = 3 (R_{GW} + R_{TR} \cdot S)$$

where:

- $R_{GW}$  : Maximum hourly rate of green water (in  $m^3$ /hour) shipped in seagoing conditions as established by the comprehensive model testing (see procedure in Article [5])
- $R_{TR}$  : Tropical rainfall hourly rate, taken equal to 0,1 m/hour
- $S$  : Hatch opening area, in  $m^2$ .

**3.2.2** For the condition with flooded holds and an intact ship, the free surfaces may be determined as follows:

- the hold(s) are loaded with cargo but the free surface is to be calculated as if the hold(s) is(are) empty
- the seawater enters the cargo hold and does not pour out during heeling
- the maximum value of the free surface moment between the filling limits envisaged in the cargo hold is to be taken into account. As an alternative, the correction to righting lever is suggested to be on the basis of real shifting moment of water in the virtual empty cargo hold. As guidance, the method described in Pt B, Ch 3, Sec 2, [4.7.3] may be applied.

**3.2.3** Calculations are to be performed for intermediate phases of hold flooding, each phase comprising an accumulated height of water of 0,25 m until the height corresponding to the volume of water accumulated and calculated according to [3.2.1], item b) is reached.

### 3.3 Damage Stability

**3.3.1** Ships assigned with the notation **OPEN-HATCH** are to comply with the subdivision and damage stability criteria of Pt B, Ch 3, Sec 3, considering the top of hatch coamings as downflooding points.

## 4 Hull

### 4.1 Hull girder strength

**4.1.1** The hull girder strength is to be checked according to the requirements in Part B, Chapter 6, Sec 2 considering the loads defined in [4.1.2] and [4.1.3].

#### 4.1.2 Still water bending moments

The design still water bending moments  $M_{SW,H}$  and  $M_{SW,S}$  are to be taken equal to the values corresponding to intact flooded conditions provided by the Designer.

#### 4.1.3 Vertical wave bending moments

The vertical wave bending moments  $M_{WV,H}$  and  $M_{WV,S}$  defined in Pt B, Ch 5, Sec 2, [3.1] are to be multiplied by 0,625.

This reduction is to be applied only for the verification of the hull girder strength but not for the verification of the hull local scantlings.

## 4.2 Hull scantlings

### 4.2.1 General

The hull scantlings of the open holds boundaries are to be checked according to the applicable requirements of Part B, Chapter 7, only for ships having the additional service feature **equipped for the carriage of containers**, considering the loads defined in [4.2.2] and the partial safety factors corresponding to the general condition.

### 4.2.2 Design loads

The still water pressure  $p_s$  corresponding to the water entrapped in holds carrying containers (considered permeability of 0,7) is to be obtained from the following formulae:

$$p_s = \rho g (z_{TOP} - z)$$

where:

- $\rho$  : Sea water density, taken equal to 1,025 t/m<sup>3</sup>
- $z_{TOP}$  : Z coordinate, in m, of the top of the hatch side or hatch coaming or, in the case of a ship fitted with cargo hold freeing ports, to the level of those ports.

It is to be used in combination with the inertial pressure  $p_w$  calculated according to Pt B, Ch 5, Sec 6, [1.1.2], using 60% of the accelerations reference values  $a_{X1}$ ,  $a_{Y1}$ ,  $a_{Z1}$ ,  $a_{X2}$ ,  $a_{Y2}$ ,  $a_{Z2}$  defined in Pt B, Ch 5, Sec 3, [3.4].

## 5 Procedure of model tests

### 5.1 General

**5.1.1** The model test procedure / programme is to be submitted to the Society for information prior model tests are carried out.

**5.1.2** The Society may require additional tests.

**5.1.3** The model experiments are to be carried out in long-crested, irregular waves. The Pierson-Moskowitz, JONSWAP, or Bretschneider wave spectrum generated for the purpose of these experiments are to have a significant wave height of 8,5 m at the most unfavourable realistic wave period (zero crossing) as determined by calculation or previous testing experience.

**5.1.4** For ships operating in restricted areas only, other spectra duly indicated on the model test programme may be accepted by the Society.

**5.1.5** The effect of wind generated spray need not be simulated during the tests.

**5.1.6** The model experiments are to be carried out for at least the following wave directions based on International Towing Tanks Conference conventions:

- following seas (0° /360°)
- quarter following seas (45° /315°)
- beam seas (90° /270°)
- quarter head seas (135° /225°)
- head seas (180°).

**5.1.7** The model experiments are to be carried out for at least the following speeds:

- maximum sustained speed in head seas and quarter head seas
- minimum ship manoeuvring speed in quarter following seas and following seas
- zero ship speed (dead ship condition) in beam seas.

**5.1.8** The model experiments are to be carried out with a self-propelled, unrestrained model without the necessity to change course. The time period of each experiment is to correspond to at least one hour real time.

**5.1.9** The loading condition used for the tests is to correspond at least to the maximum loaded draught with level trim. If operational trim values differ substantially from level trim, additional trim values are to be included in the model test programme.

**5.1.10** The vertical center of gravity (VCG) value selected is to correspond to the actual value most likely to be encountered during the ship's service for the draught close to the maximum loaded draught. If VCG values which may be expected during the operation of the ship differ substantially from this selected VCG value, additional VCG values are to be included in the model test programme.

**5.1.11** For each test condition, the cargo hold which ships most water is to be determined by preliminary tests for each combination of heading, trim and VCG. In running tests for the full duration specified in [5.1.8], this least favourable hold is to be simulated as having no cargo, whilst other cargo holds (each cargo hold as a separate entity) may be simulated as completely fully loaded. Cargo such as unit cargo is not to be used as a mean to prevent shipping of water into an empty hold by being stacked outboard of the open hold as some sort of protecting wall. Rain covers for the open holds is not to be simulated in the model tests.

**5.1.12** In addition to the usual measured parameters (ship motions, ship speed, relative motions, rudder angles, etc.), the volume of water entering all open cargo holds are to be measured for each experiment. The quantities of water taken aboard the model are to be removed and measured after each test run so that the metacentric height, moment of inertia and displacement are not appreciably disturbed by any accumulation of water during the testing programme.

**5.1.13** Where freeing ports are fitted, an additional model test to comply with [2.1.1] is to be conducted at a draught which corresponds to the condition of the ship fully loaded with cargo and open holds flooded to the static equilibrium level with freeing ports open. A hold permeability of 70% by volume is to be assumed. Tests are to be conducted at zero speed in beam seas.

**5.1.14** The Society may require an observer to witness the tests. A comprehensive report is to be submitted to the Society for information.

## 6 Ship arrangement

### 6.1 Hold bilge dewatering system and freeing ports

**6.1.1** The bilge pumping system is to have a required capacity to pump the greater of:

- the maximum hourly rate of green water shipped in seagoing conditions as established by the comprehensive model testing specified according to the procedure in Article [5]
- a rainfall of 100 mm/hour regardless of the installation of rain covers
- the amount of shipped green water measured during the seakeeping model tests according to the procedure in Article [5] for the dead ship condition in beam seas, multiplied by safety factor 2
- four-thirds of the amount of water required for fire-fighting purposes in the largest hold
- an amount equal to the capacity required for ships with closed cargo holds.

**6.1.2** The pumping of hold bilges is to be possible by at least three bilge pumps.

**6.1.3** At least one of these pumps is to have a capacity of not less than the required capacity as defined in [6.1.1] and is to be dedicated to bilge and ballast service only. It is to be located in such a way that it will not be affected by a fire or other casualty in the space containing the pumps required in [6.1.4] or the space containing the main source of power. Moreover, it is to be supplied from the emergency source of power as required in Pt C, Ch 2, Sec 3, [2.3].

**6.1.4** The combined output of at least two further pumps is not to be less than the required capacity as defined in [6.1.1]. These pumps are to be supplied from the main source of electrical power required by Pt C, Ch 2, Sec 3, [2.2], or any other source of power independent of the emergency source of power as required in Pt C, Ch 2, Sec 3, [2.3].

**6.1.5** The bilge pumping system, including the piping system, is to incorporate sufficient redundancy features so that the system is fully operational and capable of dewatering the hold spaces at the required capacity in the event of failure of any one system component.

**6.1.6** The bilge pumping system is to be arranged to be effective within the limiting angles of inclination required for the emergency source of electrical power by Pt C, Ch 2, Sec 2, [1.6], and bilge wells are to be readily accessible for cleaning.

**6.1.7** All open cargo holds are to be fitted with high bilge level alarms. The alarms are to annunciate in the machinery spaces and the manned control location and be independent of bilge pump controls.

**6.1.8** If the loss of suction prevents the proper functioning of the bilge system, special measures to prevent this are to be considered, as for instance, the installation of level indicators.

**6.1.9** Open cargo hold drain wells are to be designed to ensure unobstructed discharge of water and easy access for cleaning under all conditions.

**6.1.10** Where tween decks are fitted and form wells, ample provisions are to be made for rapidly freeing the tween decks from water and for draining them through evenly distributed openings. The minimum freeing port area on the tween decks fitted along the holds are to be calculated in accordance with Pt B, Ch 8, Sec 10, [6], considering the height of the bulkwark  $h_B$  as the mean height between the tween deck and the top of hatch coaming.

**6.1.11** If provided, freeing ports are to be fitted on both sides of each open cargo hold, subject to the following:

- the number, size and location of the freeing ports on each side of each open hold is to be sufficient to prevent the accumulation of water above the level defined in [5.1.13]
- efficient means of closure to prevent the accidental ingress of water are to be provided. Such means are to be operated from above the freeboard deck. In the case of a ship operating in areas where icing is likely to occur, these arrangements are to be suitable to enable the ports to operate efficiently under such conditions.

## 7 Fire protection

### 7.1 Fire insulation

**7.1.1** Open hatch cargo holds are to be considered as enclosed cargo holds for the purpose of applying Part C, Chapter 4, except that no fire division is required between an open hatch cargo hold and open deck, notwithstanding the requirements of Pt C, Ch 4, Sec 5, [1.4].

**7.1.2** The fire detection system is to be designed and arranged to account for the specific hold configuration and ventilation arrangement.

### 7.2 Water-spray system

**7.2.1** Open hatch cargo holds are to be protected by a fixed water spray system complying with the requirements of the present sub-article.

**7.2.2** The water-spray system is to be subdivided into sections, with each section consisting of a ring-line at deck level covering a complete cargo hold.

**7.2.3** The system is to be capable of spraying water into the cargo hold from deck level downward.

**7.2.4** The water spray system is to be capable of spraying the outer vertical boundaries of any one cargo hold and of cooling the adjacent structure. The uniform application density is to be not less than 1,1 litres/min/m<sup>2</sup>.

**7.2.5** At least one dedicated fire extinguishing pump for the hold water spray system is to be provided, with a capacity sufficient to serve any one open hatch cargo hold. The pump is to be installed outside the open hatch area.

Failure of any one dedicated pump is not to result in a reduction of the water flow capacity by more than 50%. In addition, the spray patterns in the open hatch cargo holds in this configuration are to ensure a uniform water application. In the case of a single dedicated water spray pump, this may be achieved by an interconnection to an alternative means of pumping from the weather deck. The interconnection valve is to be located outside the open hatch area and is to remain easily accessible in case of a fire in this area.

**7.2.6** Water spray nozzles are to be of an approved type.

## 7.3 Dangerous goods

**7.3.1** Open hatch cargo holds intended for the carriage of dangerous goods are to comply with the requirements of Pt C, Ch 4, Sec 12 considering the hold as an enclosed cargo space not specifically designed for the carriage of freight containers, but intended for the carriage of dangerous goods in packaged form, including goods in freight containers and portable tanks. The hold is not to be considered as a weather deck.

## 8 Testing

### 8.1 Onboard tests

#### 8.1.1 Water-spray system

The water-spray system is to be checked for leakage at normal operating pressure and to undergo an operational test. The testing is to include verification of the functionality of the drainage arrangements.

#### 8.1.2 Hold dewatering system

A functional test of the hold dewatering system is to be carried out.

# SECTION 34 FSRU-READY

## 1 General

### 1.1 Application

**1.1.1** The additional class notation **FSRU-READY** is assigned, in accordance with Pt A, Ch 1, Sec 2, [6], to ships having the service notation **liquefied gas carrier** that are designed and built with specific arrangements in view of accommodating future installation of a regasification system, in accordance with the requirements of this Section.

**1.1.2** The additional class notation **FSRU-READY** may be completed between brackets by one, or by a combination, of the following notations:

- **P** when specific arrangements for piping and process systems are taken into account during the initial design of the ship in order to consider additional capacity for a future conversion
- **R** when the regasification system, or main pieces of equipment, are defined at the time of assignment of the notation
- **I** when the ship is designed and built in order to allow on-site in-water survey without dry-docking once converted into FSRU and subject to acceptance from Authorities.

Note 1: Examples of notations are given below:

- **FSRU-READY**
- **FSRU-READY(P)**
- **FSRU-READY(P, R, I)**

### 1.2 Definition

#### 1.2.1 Site condition

The site condition is the environmental condition expected during the on-site operation phase under regasification mode, and the resulting loads acting on the unit.

### 1.3 Plans and documents to be submitted

**1.3.1** The documentation required in the scope of the additional class notation **FSRU-READY** is to be submitted to the Society for information unless drawings describe items actually installed on board at the time of assignment of the notation.

**1.3.2** The plans and documents to be submitted are listed in Tab 1.

### 1.4 Conversion to FSRU

**1.4.1** The conversion to FSRU corresponds to the actual installation onboard of all the pieces of equipment required to have a fully operational regasification unit.

Note 1: Guidelines for conversion to FSRU are given in NI 655, LNG Carrier Conversion to FSRU or FSU.

**1.4.2** The installation is to be in compliance with the applicable requirements of the **liquefied gas carrier - FSRU** (or **FSRU**) notation set out in NR645, as applicable at the date of conversion.

Each equipment is to be in compliance with the applicable Rule requirements at the time of its actual installation onboard.

**1.4.3** When the liquefied gas carrier is converted to a floating regasification unit, notations will be replaced as follow:

- a) the service notation **liquefied gas carrier** is replaced by the service notation **liquefied gas carrier - FSRU** (or **FSRU**), provided that all the applicable requirements are complied with (see NR645 Rules for the classification of floating storage regasification units and floating storage units).
- b) the additional class notation **FSRU-READY** is deleted
- c) the additional service feature **REGAS** is assigned to the unit, provided that all the applicable requirements are complied with the requirements of NR645, Section 10.

## 2 Requirements for the additional class notation FSRU-READY

### 2.1 Assumption for site condition

**2.1.1** Assumed site conditions for FSRU operation are to be defined at the time of assignment of the notation. Navigation notations may be used as a reference for this purpose in order to cover a variety of possible site conditions.

Details of the site specifications, consisting in the name of field and/or geographical area and/or the most unfavorable sea conditions where the unit is intended to operate may also be used to cover specific site condition.

Note 1: The navigation notation **sheltered area** may be assigned after conversion to **liquefied gas carrier-FSRU** or **FSRU** for operation on site to cover a number of site conditions (i.e. harbours, estuaries, roadsteads, bays, lagoons and generally calm stretches of water).

In both cases, the data, limitations and assumptions used for the assessment of the unit on site are to be stated in the Design Criteria Statement, as defined in NR645, Sec 1, [8.1], which is to be referred to in a memorandum on the class certificate.

Table 1 : Plans and documents to be submitted

Notation	No.	Plans and documents to be submitted	Approval status (A/I) (1)
<b>FSRU-READY</b>	1	General arrangement drawing of the ship showing the regasification spaces and installations, either fitted at the new building stage or planned at a subsequent stage (2), in particular: <ul style="list-style-type: none"> <li>• regasification skid</li> <li>• foundations for the support of regasification skid</li> </ul>	A
	2	Design data for operation on-site, in particular: <ul style="list-style-type: none"> <li>• site environmental data or,</li> <li>• specific navigation notation for the site condition</li> </ul>	I
	3	Drawing showing the hazardous areas and their classification, taking into account the foreseen regasification system	A
	4	Details of electrical equipment installed in the hazardous areas, including the list of certified safe equipment	A
	5	Arrangement of accesses to the regasification spaces	I
	6	HAZID analysis (see [2.2.5])	I
<b>P</b>	7	Schematic diagram and arrangement of the piping systems	A
	8	Schematic diagram and arrangement of the fire protection systems (including the future installations of regasification)	A
	9	Specific arrangement of spaces for modification of systems, in particular: <ul style="list-style-type: none"> <li>• ventilation systems</li> <li>• electrical installations</li> <li>• fire fighting systems</li> </ul>	A
<b>R</b>	10	Documents of the regasification plan listed in NR645, Sec 10, Tab1	I/A (4)
<b>I</b>	11	Specific in-service inspection program in accordance with NR645, Sec 15	I
	12	Specific arrangements (see NR645, Sec 14), paying particular attention to: <ul style="list-style-type: none"> <li>• cargo tanks</li> <li>• safety valves</li> <li>• cargo pumps</li> <li>• regasification plant (3)</li> <li>• electrical equipment</li> <li>• inert gas system</li> </ul>	A

(1) A : Document to be submitted for approval  
I : Document to be submitted for information.

(2) The equipment and systems installed at the time of assignment of the notation and those intended to be installed at a subsequent stage are to be clearly identified on the drawing.

(3) When the additional class notation **FSRU-READY** is completed by the notation **R**

(4) Depending on the approval status required in NR645, Sec 10, Tab 1.

**Note 1:** No additional or duplication of documents are required to be submitted when above technical contents are already presented and included in typical standard unit's drawing.

## 2.2 General arrangement

**2.2.1** The design of the ship is to take into account the necessary spaces or zones to accommodate the following installations:

- regasification skid(s)
- foundations for the support of regasification skid(s).

**2.2.2** The arrangement and location of the regasification area are to comply with the provisions of NR645, Section 10.

**2.2.3** Accesses to, and escape routes from, the regasification area are to comply with the provisions of NR645, Section 10.

**2.2.4** The hazardous / non-hazardous area classification in the regasification area is to be defined in accordance with the provisions of NR645, Section 10.

The types of electrical equipment permitted, depending on the zone where they are installed, are specified in Pt C, Ch 2, Sec 3.

**2.2.5** A HAZID analysis is to be conducted to ensure that risks arising from regasification operations are addressed. Relevant hazards and risks scenarios with respect to regasification operations are to be identified as defined in NR645, Sec 10, [1.4.1], as applicable.

## 2.3 Hull and stability

**2.3.1** The ship stability is to be assessed for preliminary loading conditions, and is to comply with the relevant provisions of NR645, Sec 3, [2].

**2.3.2** The hull structure of the ship in way of the regasification skid(s) is to be protected against cryogenic spill. See NR645, Sec 10, [1.6.4].

**2.3.3** The local structural reinforcements in way of the regasification skid(s) are to be justified by calculations and effectively fitted on board the ship.

## 2.4 Design loads

**2.4.1** Loading conditions are to be representative of every configuration of weight distribution and the assessment of the structure is to consider relevant loads depending on the assumption for site condition defined in [2.1].

**2.4.2** For each loading condition the load cases defined in NR645, Section 5 are to be considered taking into account the assumption for site condition defined in [2.1].

## 2.5 Structural strength

**2.5.1** The structural strength of the ship is to be assessed assuming the regasification installation in ready-for-use condition, and is to comply with the requirements given in NR645, Section 7 taking into account the assumption for site condition defined in [2.1].

## 2.6 Slashing on-site

**2.6.1** As defined in NR645, Sec 9, [2], all cargo tanks are to be checked for several relevant partial filling levels.

Note 1: Subject to the acceptance of the Society, direct slashing calculations need not be performed for site areas where the extreme 100 years return period significant wave height is less than 1,5 m.

## 3 Additional requirements for notations P, R and I

### 3.1 Notation P

**3.1.1** The initial design of the ship is to take into account the spaces intended for the future installations of regasification and associated piping systems.

**3.1.2** Piping installations fitted to the ship at the initial design stage and which will be used for the future regasification installation are to be in accordance with the requirements given in NR645, Sec 10, [1.7].

**3.1.3** The initial design of the ship is to take into account the space for modification of fire fighting systems (fire main and hydrants, water spray systems and dry chemical powder system) in order to consider additional capacity.

**3.1.4** The initial design of the ship is to take into account the space for modification of ventilation systems in order to consider additional capacity.

**3.1.5** The initial design of the ship is to take into account the space for modification of power generation and distribution system in order to consider additional capacity.

Electrical installations fitted to the ship at the initial design stage and which will be used for the future regasification installation are to be in accordance with requirements of NR645, Section 11.

### 3.2 Notation R

**3.2.1** The foreseen regasification skid, and main pieces of equipment, are to be in accordance with the requirements given in NR645, Section 10.

### 3.3 Notation I

**3.3.1** The initial design of the ship is to allow the surveys and tests, as defined in NR645, Section 15, to be undertaken to the required extent, paying particular attention to sea water system, cargo tanks, safety valves, cargo pumps, electrical equipment in hazardous areas and inert gas system as defined in NR645, Sec 14, [2.2] to [2.4].

**3.3.2** When the additional class notation **FSRU-READY** is completed by the notation **R**, arrangements are to be made at design stage to allow internal and external inspections of the pieces of equipment of the future regasification installation when the plant is in operation.

**3.3.3** A specific in-service inspection program for future use in regasification mode is to be approved by the Society and is to be listed in a memoranda.

## SECTION 35

## AMMONIA-PREPARED SHIPS

### 1 General

#### 1.1 Application

**1.1.1** The additional class notation **AMMONIA-PREPARED** is granted to new ships that are designed with specific arrangements to accommodate future installation of an ammonia fuel system, in accordance with the requirements of this Section. The following cases are considered:

- a) The ship is designed for:
  - original operation on oil fuel and
  - future conversion to dual fuel operation, i.e. on oil fuel and ammonia fuel.
- b) The ship is designed for:
  - original dual fuel operation on oil fuel and methane fuel and
  - future conversion to dual fuel operation with oil fuel and ammonia fuel, i.e. methane fuel is not used anymore.
- c) The ship is designed for:
  - original dual fuel operation with oil fuel and methane fuel and
  - future conversion to tri-fuel operation, i.e. on oil fuel or methane fuel or ammonia fuel. Methane fuel and ammonia fuel can be used alternately or simultaneously.
- d) The ship is designed for:
  - original dual fuel operation on oil fuel and LPG fuel and
  - future conversion to dual fuel operation with oil fuel and ammonia fuel, i.e. LPG fuel is not used anymore.
- e) The ship is designed for:
  - original dual fuel operation with oil fuel and LPG fuel and
  - future conversion to tri-fuel operation, i.e. on oil fuel or LPG fuel or ammonia fuel. LPG fuel and ammonia fuel can be used alternately or simultaneously.

**1.1.2** The additional class notation **AMMONIA-PREPARED** may be completed between brackets with one or a combination of the following notations **S**, **T**, **H**, **P** and **B**:

- **S** when specific arrangements are implemented for the ship structure at the original design stage with the aim of preventing the need for specific structural modifications at the conversion stage (see Article [3])

- When the ship is originally designed to use LNG or LPG as fuel:
  - **T** when at least one original LNG or LPG fuel storage tank can also be used with ammonia fuel, possibly with modifications of the operational conditions of the tank at the ship conversion stage (see Article [4])
  - **H** when the original LNG or LPG fuel handling equipment (pumps, heat exchangers, compressors) can also be used with ammonia (see Article [5])
  - **P** when the original LNG or LPG piping system can also be used with ammonia (see Article [6])
  - **B** when the original LNG or LPG boil-off gas management method (other than pressure accumulation, i.e. combustion unit, boiler or refrigerating system) can also be used with ammonia (see Article [7]).

Examples:

**AMMONIA-PREPARED**

**AMMONIA-PREPARED (T)**

**AMMONIA-PREPARED (S,T,H)**

**1.1.3** When the ship is effectively converted to operate on ammonia fuel, the additional class notation **AMMONIA-PREPARED** may be replaced by the additional service feature **ammoniafuel dualfuel**, provided that all the applicable requirements, in particular those of Rule Note NR671, are complied with.

#### 1.2 Documents and information to be submitted

**1.2.1** The plans and documents to be submitted are listed in Tab 1.

#### 1.3 Definitions

**1.3.1** “Ammonia fuel handling system” means the equipment necessary for pumping, vaporizing, heating or compressing the ammonia fuel.

**1.3.2** “Ammonia valve unit” means a set of shut-off valves, venting valves, pressure control valve, flow meter, filter and pressure / temperature transmitters and gauges, located on the ammonia fuel supply to each consumer.

**1.3.3** “Ammonia combustion unit” means a system intended for the combustion of boil-off ammonia vapour in excess or ammonia vapours from piping safety valve discharges, venting systems, etc.

**1.3.4** “Ammonia dissolution system” means a system where ammonia vapours are dissolved in a water tank.

**1.3.5** “Ammonia scrubber” means a system intended for dissolving ammonia vapours in sprayed water. It can be used as a mean to control the boil-off ammonia vapour in excess or to treat the ammonia vapour released from piping safety valve discharges, venting systems, etc.

**1.3.6** “A space or area where ammonia may be present” means a space identified by the risk analysis as containing a possible source of leakage.

## 1.4 Ammonia main characteristics and consequences on the design of the ship installations

**1.4.1** The main characteristics of ammonia that may influence the initial design of the ship with the aim to convert it to the use ammonia as fuel at a future stage are summarized in Tab 2.

**Table 1 : Documents to be submitted**

Notation	No.	Documents and information to be submitted	(A/I) (1)	
AMMONIA-PREPARED	For all ships (see [2]):			
	1	General arrangement drawing of the ship showing the areas and spaces where ammonia may be present and the associated installations, either fitted at the new building stage or planned at a later stage, in particular: <ul style="list-style-type: none"> <li>• the ammonia bunkering station(s)</li> <li>• the ammonia tank(s)</li> <li>• the ammonia boil-off management system(s) (refrigerating system, thermal oxidation system), where fitted</li> <li>• the ammonia fuel handling system</li> <li>• the ammonia valve units</li> <li>• the ammonia leakage treatment and recovery systems</li> <li>• the vent mast(s)</li> <li>• the inert gas system.</li> </ul> The equipment and systems installed at the new building stage and those intended to be installed at a later stage are to be clearly identified on the drawing.	A	
	2	General specification of the contemplated ammonia fuel installation including: <ul style="list-style-type: none"> <li>• type and capacity of the ammonia storage tanks, range of pressure and temperature anticipated under operational conditions</li> <li>• bunkering method (from terminal, bunker ship or barge, truck)</li> <li>• boil-off management principle</li> </ul>	I	
	3	Drawing showing the hazardous areas and their classification, assuming that all ammonia installations are fitted onboard	A	
	4	Drawing showing the areas where ammonia may be present	A	
	5	Drawing showing the structural fire protection and cofferdams provided in connection with ammonia installations	A	
	6	Longitudinal strength calculations and stability calculations covering the loading conditions assuming the ammonia installation in ready-for-use condition	A	
	7	Arrangement of accesses to the spaces where ammonia may be present	A	
	8	Arrangement of the ventilation systems serving the spaces where ammonia may be present	A	
	9	Calculation of the hull temperature in all design conditions (for membrane tanks and type A tanks)	I	
	10	Distribution of quality and steel grades in relation to the values obtained from the hull temperature calculation (for membrane tanks and type A tanks)	A	
	11	Report of HAZID analysis (see [2.1.5])	I	
	12	Electrical balance and heat balance anticipated with the use of ammonia as fuel	A	
S	For the hull structure (see [3]):			
	13	Structural drawings for the following spaces: <ul style="list-style-type: none"> <li>• ammonia bunkering station</li> <li>• ammonia tank holds</li> <li>• ammonia fuel handling room</li> <li>• ammonia valve unit room (where fitted)</li> </ul>	A	
	14	Calculations of the local structural reinforcements in way of machinery, piping components and supports of Type-A or Type-C tanks associated with the use of ammonia as fuel	I	
(1) A: document to be submitted for approval; I: document to be submitted for information				



Notation	No.	Documents and information to be submitted	(A/I) (1)
<b>T</b>	For the fuel tank (see [4]):		
	15	Manufacturer's document describing the ammonia readiness of the original tank and the modifications foreseen at a later stage	I
	16	Tank material specification	A
	17	Structural analysis as per IGC Code, Chapter 4	A
	18	Sloshing calculation covering the full range of intended filling levels (for membrane tanks and type A tanks)	A
<b>H</b>	For the fuel handling system (see [5]):		
	19	Manufacturer's document describing the ammonia readiness of the original fuel handling system and the modifications foreseen at a later stage	I
	20	Justifications regarding the suitability of the concerned equipment (pumps, heat exchangers, compressors) for use with ammonia, in particular with respect to operating characteristics, capacity and materials	A
<b>P</b>	For the fuel piping system (see [6]):		
	21	Manufacturer's document describing the ammonia readiness of the original fuel piping system and the modifications foreseen at a later stage	I
	22	Schematic diagram and arrangement of the ammonia (liquid and vapour) piping systems, including venting systems	A
	23	Arrangement of the venting mast	A
<b>B</b>	For boil-off gas management (tanks other than fully pressurized type C tanks) see [7]:		
	24	Manufacturer's document describing the ammonia readiness of the original boil-off vapour management system(s), in particular its capability to control the tank pressure and temperature, and the modifications foreseen at a later stage	I
	25	Calculations of the boil-off rate of the tank when containing ammonia, for the different operating conditions (maximum ambient temperature, filling rates, pressure and temperature in the tank after bunkering)	A

(1) A: document to be submitted for approval; I: document to be submitted for information

**Table 2 : Characteristics of ammonia that may influence the initial design of the ship**

Characteristics	Typical value		Consequences on the design of ammonia installations versus methane fuel
	Ammonia	Methane fuel	
Liquid density (at 1 bar, in kg/m <sup>3</sup> )	672	422	<ul style="list-style-type: none"> <li>higher static and dynamic load on the tank structure</li> <li>pumps may need to be replaced</li> </ul>
Liquid volumetric energy density (LHV, in GJ/m <sup>3</sup> )	12,7	23,4	<ul style="list-style-type: none"> <li>larger volume for the storage tank</li> <li>larger diameter for piping</li> </ul>
Boiling point (at 1 bar, in °C)	-33	-161	lower heat ingress in the refrigerated storage tanks, less insulation or refrigerating capacity required
Vapour pressure (in bar)	18 (at 45°C) 10 (at 25°C)	-	<ul style="list-style-type: none"> <li>pressurized storage possible at ambient temperature</li> <li>where ammonia is used in gaseous state, risk of condensation in case of temperature decrease</li> </ul>
Latent heat of vaporization (kJ/kg)	1370 (at -33°C)	510 (at -161°C)	<ul style="list-style-type: none"> <li>ammonia requires higher heat amount for its vaporization</li> <li>lower boil-off rate</li> </ul>
Specific heat capacity Cp (liquid, kJ/kg.°C)	4,7	3,4	liquid ammonia requires higher heat for the same temperature increase
Toxicity			<ul style="list-style-type: none"> <li>ammonia is toxic when inhaled and for aquatic life when discharged into the sea</li> <li>unburnt ammonia may be present in exhaust gases from engines</li> </ul>
Global warming potential			N <sub>2</sub> O in exhaust gases from engines is a strong greenhouse gas (GHG)
Corrosivity			use of materials compatible with ammonia

## 2 General requirements for the additional class notation AMMONIA-PREPARED

### 2.1 Design principles

**2.1.1** The initial design of the ship is to take into account the specific characteristics of ammonia listed in [1.4].

**2.1.2** The design of spaces intended to accommodate the ammonia storage tanks is to take into account the required fuel capacity to cover the operating range of the ship.

**2.1.3** The additional electrical and thermal power that may be necessary to supply the ammonia systems is to be taken into account.

**2.1.4** All parts of the ship that may be in contact with ammonia are to be made of materials compatible with ammonia.

**2.1.5** An HAZID analysis is to be conducted to ensure that the risks arising from the use of ammonia fuel are addressed, in particular the risks related to its toxicity. Loss of function, system damage, spillage of liquid ammonia or release of ammonia vapours, fire and explosion are, as a minimum, to be considered. The results of the HAZID are to be implemented in the design of the ammonia systems.

### 2.2 General arrangement

**2.2.1** The initial design of the ship is to take into account the necessary spaces or zones to accommodate the future installation of the following installations:

- a) Ammonia fuel bunkering station
- b) Ammonia fuel storage tanks:
  - pressurized, refrigerated or semi-refrigerated type C tanks
  - refrigerated type A tanks
  - refrigerated membrane tanks.
- c) Ammonia fuel handling system
- d) Ammonia boil-off management system, where required, including:
  - ammonia combustion unit
  - ammonia refrigerating system
  - ammonia dissolution system
  - ammonia scrubber.

For pressurized or semi-pressurized type C tanks where the capability of the pressure accumulation method is justified, one boil-off management system is to be provided.

For other types of tanks, two boil-off management systems are to be provided.

- e) Ammonia leakage drainage tank.

- f) Ammonia effluents storage tank.
- g) Ammonia vapour treatment systems.
- h) Ventilation systems (independent systems).
- i) Ammonia valve units.
- j) Vent mast.

**2.2.2** The arrangement and location of spaces where ammonia may be present are to comply with the provisions of NR529, [5.2], [5.8], [6.2] and [8.3].

**2.2.3** The space below deck or the area above deck where the ammonia storage tanks will be installed are to comply with the requirements for protective location of the tank given in NR529, [5.3].

**2.2.4** The access to spaces where ammonia may be present is to comply with the provisions of NR529, [5.11]. Where required, air locks are to be provided.

**2.2.5** The hazardous / non-hazardous area classification of the spaces where ammonia may be present is to be defined in accordance with the provisions of NR529, [12.5].

**2.2.6** The ship ventilation is to be arranged in accordance with the provisions of NR529, [13], in particular as regards the separation between the ventilation systems serving spaces where ammonia may be present and those serving other spaces. The free-sectional area of the ventilation ducts is to take into account the air flow rates required for spaces where ammonia may be present.

### 2.3 Ship structure and stability

**2.3.1** The ship stability is to be assessed for preliminary loading conditions, assuming the ammonia installation in ready-for-use condition, and to comply with the relevant provisions of the Rules. The relevant loads are to be stated.

The longitudinal strength of the ship is to be assessed, assuming the ammonia installation in ready-for-use condition, and to comply with the relevant provisions of the Rules.

**2.3.2** The ship structure in way of the tanks is to take into account the density of ammonia.

**2.3.3** Where a type A tank or a membrane tank is used for the storage of refrigerated ammonia fuel, the hull material in way of the tank is to be selected in relation to the values obtained from the hull temperature calculation (see NR529 table 7.5).

### 2.4 Machinery

**2.4.1** All installations and equipment necessary for the ship to operate on ammonia and that are fitted to the ship at the initial design stage are to comply with the relevant provisions of IMO IGF Code and NR671.

### 3 Additional requirements for notation S

#### 3.1 General

**3.1.1** The structural arrangements and reinforcements in way of machinery, piping components and supports of Type-A or Type-C tanks associated with the use of ammonia as fuel are to be implemented at the original design stage with the aim of preventing the need for specific structural modifications at the conversion stage.

### 4 Additional requirements for notation T

#### 4.1 General

**4.1.1** A tank design may be eligible for the notation **T** if the tank characteristics are also suitable for ammonia, as per [4.2].

The operational conditions of the tank (e.g. operating pressure or maximum filling level) may however be modified at the ship conversion stage.

**4.1.2** The tank design is to be assessed by the Society in accordance with the requirements of this Section.

Note 1: Upon request, an Approval in Principle may be issued by the Society upon satisfactory completion of the procedure.

#### 4.2 Design of the ammonia storage tank

##### 4.2.1 Material compatibility

The original tank is to be made of a material complying with the provisions of IGC Code, regulations 17.12.1 to 7.

##### 4.2.2 Scantling

The scantling of the original tank is to take into account the higher static and dynamic load on the tank structure due to the density of liquid ammonia, the maximum expected service pressure and, where applicable, the sloshing loads for the full range of intended filling levels.

Type C tanks intended to be used with ammonia at ambient temperature are to be designed for the vapour pressure of ammonia corresponding to a temperature of 45°C.

For membrane tanks, the reinforcements necessary for the containment systems are to be implemented at initial building stage.

##### 4.2.3 Tank connections

The diameter of the tank connections is to be sufficient to allow the required flow rates, taking into account the energy density of ammonia and the permissible velocity.

The tank is to be fitted, at the initial design stage, with all the connections necessary for operation with ammonia. In particular, where deemed necessary, a vapour return connection is to be fitted.

##### 4.2.4 Pumps

Where original submerged pumps need to be replaced at the ship conversion stage, the corresponding parts of the tank (such as tank opening and pump supporting arrangements) are to be designed for the expected size of the ammonia pump.

##### 4.2.5 Instrumentation

The tank is to be fitted, at the design stage, with all the necessary penetrations for the instrumentation relevant to ammonia operation.

### 5 Additional requirements for notation H

#### 5.1 General

**5.1.1** The original fuel handling system may be eligible for the notation **H** if it has characteristics also suitable for use with ammonia, as per [5.2].

**5.1.2** The fuel handling system design is to be assessed by the Society in accordance with the requirements of this Section.

Note 1: Upon request, an Approval in Principle may be issued by the Society upon satisfactory completion of the procedure.

#### 5.2 Design of the ammonia fuel handling system

##### 5.2.1 Design parameters

The fuel handling system intended for ammonia is to be designed for the pressure and temperature conditions and the flow rate required at the engine inlet.

The capacity of the ammonia fuel handling system is to take into account the characteristics of ammonia, in particular its volumetric energy density, heat of vaporization and heat capacity.

##### 5.2.2 Material compatibility

The components of the ammonia fuel handling system are to be made of materials compatible with ammonia.

### 6 Additional requirements for notation P

#### 6.1 General

**6.1.1** The original fuel piping system may be eligible for notation **P** if it has characteristics also suitable for use with ammonia, as per [6.2].

#### 6.2 Design of the ammonia piping system

**6.2.1** The piping system intended for ammonia is to be designed for the pressure and temperature conditions expected in the different parts of the system.

**6.2.2** Pipe diameters are to be suitable for the maximum expected flow rates, taking into account the energy density of ammonia and the maximum allowable velocity.

**6.2.3** Materials used for pipes (including the enclosing duct or pipe), valves and fittings are to be compatible with ammonia. This also applies to gaskets.

**6.2.4** The risk of condensation in ammonia vapour lines, when the temperature in the concerned spaces may be below the saturation temperature of ammonia at the maximum service pressure, has to be taken into account. The

design of the piping system is to allow heating arrangements to be added at the ship conversion stage, where necessary, to maintain ammonia at a sufficient temperature.

## **7 Additional requirements for notation B**

### **7.1 General**

**7.1.1** The original boil-off gas management system may be eligible for the notation **B** if it has characteristics also suitable for use with ammonia, as per [7.2] and [7.3].

**7.1.2** The boil-off gas management system design is to be assessed by the Society in accordance with the requirements of this Section.

Note 1: Upon request, an Approval in Principle may be issued by the Society upon satisfactory completion of the procedure.

### **7.2 Design of the ammonia combustion unit (thermal oxidizer)**

**7.2.1** The combustion unit (thermal oxidizer) is to be originally designed so that it will ensure complete burning of

ammonia for the full ranges of pressures, temperatures and flow rates of the ammonia boil-off vapours, while fulfilling the applicable emission standards.

**7.2.2** Some components such as the burner, combustion fans, igniters, pilot burner or flame scanning system may be modified or replaced at the ship conversion stage.

**7.2.3** Materials used for the different parts of the combustion unit or boiler, including piping, valves and fittings are to be compatible with ammonia.

### **7.3 Design of the refrigerating system**

**7.3.1** The refrigerating system is to be originally designed so that it will provide adequate refrigerating capacity for the ammonia liquid or vapours in the storage tanks to control its pressure.

**7.3.2** Materials used for the different parts of the refrigerating unit, including piping, valves and fittings are to be compatible with ammonia.

## SECTION 36

## SUSTAINABLE SHIPS

### 1 General

#### 1.1 Scope

**1.1.1** The additional class notation **SUSTAINABLESHIP-1** or **SUSTAINABLESHIP-2** may be assigned to ships that are designed, built and equipped according to the requirements of this Section focusing on the following sustainability aspects:

- prevention of sea and air pollution
- protection of the marine environment
- reduction of greenhouse gases emissions
- preparation for ship recycling
- enhancement of people well-being on board.

#### 1.2 Notation **SUSTAINABLESHIP-1**

**1.2.1** The requirements for the assignment of the additional class notation **SUSTAINABLESHIP-1** are those corresponding to a combination of class notations, their applicable associated requirements and any additional requirements, covering the sustainability aspects.

The required combination includes all the following class notations, their applicable associated requirements and any additional requirements, as detailed below for each of the sustainability aspects:

- a) Prevention of sea and air pollution:
  - **CLEANSHIP**
  - **PROTECTED FO TANK**, only for ships having an aggregate fuel oil tank capacity of less than 600 m<sup>3</sup>
  - **EGCS SCRUBBER**, applicable to ships fitted with scrubber, with the additional requirement for the scrubber to be of a closed-loop type
  - **VCS**, applicable to ships which are assigned one or more of the following class notations:
    - **oil tanker**
    - **chemical tanker**
    - **FLS tanker**
    - **liquefied gas carrier**
    - **combination carrier/OOC**
    - **combination carrier/OBO**
- b) Protection of the marine environment:
  - **BWT**
- c) Reduction of greenhouse gases emissions:
  - **SEEMP**
  - The following requirement applies to the ship's Energy Efficiency Design Index (EEDI) as defined in MARPOL Annex VI Chapter 4:

The Attained EEDI value is to comply with the required EEDI Phase 2 which means the EEDI reference line with the reduction factors for phase 2 as defined in IMO Resolution MEPC.324(75) for the applicable ship type.

The EEDI technical file is to be submitted to the Society and the attained EEDI value is to be verified by the Society.

- d) Preparation for ship recycling:

**GREEN PASSPORT** or

**GREEN PASSPORT EU.**

#### 1.3 Notation **SUSTAINABLESHIP-2**

**1.3.1** The requirements for the assignment of the additional class notation **SUSTAINABLESHIP-2** are those corresponding to a combination of class notations, their applicable associated requirements and any additional requirements, covering the sustainability aspects.

The required combination includes all the following class notations, their applicable associated requirements and any additional requirements, as detailed below for each of the sustainability aspects:

- a) Prevention of sea and air pollution
  - **CLEANSHIP SUPER** completed between brackets by three additional class notations among those referred to as "eligible" for assignment of the notation **CLEANSHIP SUPER** in Ch 9, Sec 1
  - **PROTECTED FO TANK** only for ships having an aggregate fuel oil tank capacity of less than 600 m<sup>3</sup>
  - **NDO-x days**, which is an eligible class notation for **CLEANSHIP SUPER**
  - **OWS-x ppm**, which is an eligible class notation for **CLEANSHIP SUPER**
  - **EGCS SCRUBBER** applicable to ships fitted with scrubber, with the additional requirement for the scrubber to be of a closed-loop type. This class notation is eligible for **CLEANSHIP SUPER**
  - **VCS**, applicable to ships which are assigned with one or more of the following class notations:
    - **oil tanker**
    - **chemical tanker**
    - **FLS tanker**
    - **liquefied gas carrier**
    - **combination carrier/OOC**
    - **combination carrier/OBO**
  - **TIER III**, applicable to ships fitted with internal combustion engine

- b) Protection of the marine environment:
- **BWT**, which is an eligible class notation for **CLEANSHIP SUPER**
  - **URN**
- c) Reduction of greenhouse gases emissions:
- **SEEMP**
  - One of the following class notations is applicable:
    - **BATTERY SYSTEM** or **ELECTRIC HYBRID** or **HYBRID MECHANICAL PROPULSION** or
    - **fuelcell** or
    - **WPS1** or **WPS2** or
    - **LNGfuel** or **CNGfuel** or **LPGfuel** or **methanolfuel** or **ammoniafuel**
  - The following requirement applies to the ship's Energy Efficiency Design Index (EEDI) as defined in MARPOL Annex VI Chapter 4:  
The Attained EEDI value is to comply with the required EEDI Phase 3 which means the EEDI reference line with the reduction factors for phase 3 as defined in IMO Resolution MEPC.324(75) for the applicable ship type.

The EEDI technical file is to be submitted to the Society and the attained EEDI value is to be verified by the Society.

- d) Preparation for ship recycling:
- **GREEN PASSPORT** or
  - **GREEN PASSPORT EU**
- e) Enhancement of people well-being on board
- **HABITABILITY**
  - **COMF-NOISE**
  - **COMF-VIB.**

## 1.4 Surveys

**1.4.1** The survey requirements for the assignment and maintenance of the additional class notations **SUSTAINABLESHIP-1** and **SUSTAINABLESHIP-2** are those respectively applicable to each required class notation of the combination.



**BUREAU  
VERITAS**

Shaping a World of Trust

Marine & Offshore  
Le Triangle de l'Arche - 8 Cours du Triangle - CS 50101  
92937 Paris La Defense Cedex - France  
Tel: + 33 (0)1 55 24 70 00  
<https://marine-offshore.bureauveritas.com/bv-rules>  
© 2021 Bureau Veritas – All rights reserved